

## **AXIS Q6215-LE PTZ Network Camera**

## **User Manual**

# AXIS Q6215-LE PTZ Network Camera

## Table of Contents

---

<b>Product overview</b> .....	3
<b>Find the device on the network</b> .....	4
Access the device .....	4
About secure passwords .....	4
<b>Setup</b> .....	5
Webpage overview .....	5
Image quality .....	7
Privacy masks .....	8
Overlays .....	8
PTZ (Pan Tilt Zoom) .....	9
Streaming and storage .....	10
Rules and alerts .....	11
Applications .....	14
<b>Troubleshooting</b> .....	15
Reset to factory default settings .....	15
Check the current firmware .....	15
Upgrade the firmware .....	15
Technical issues, clues and solutions .....	16
Performance considerations .....	17
<b>Specifications</b> .....	18
SD card slot .....	18
Buttons .....	18
Connectors .....	18

# AXIS Q6215-LE PTZ Network Camera

## Product overview

---

### Product overview

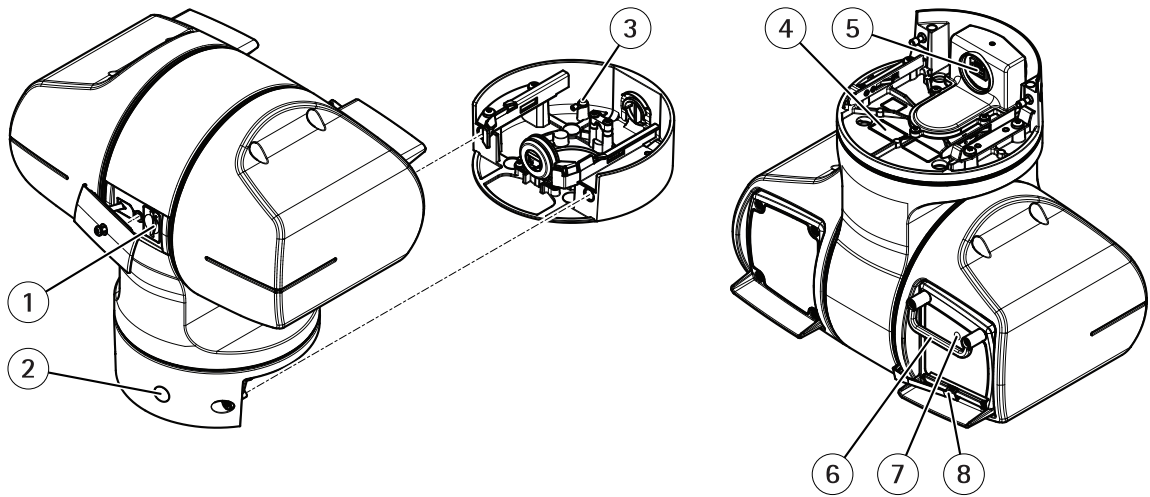

- 1 SD card slot
- 2 Control button
- 3 Ground screw
- 4 Part number (P/N) & Serial number (S/N)
- 5 Network connector (High PoE)
- 6 Impact protection bracket
- 7 Status LED
- 8 Wiper

# AXIS Q6215-LE PTZ Network Camera

## Find the device on the network

---

### Find the device on the network

To find Axis devices on the network and assign them IP addresses in Windows®, use AXIS IP Utility or AXIS Device Manager. Both applications are free and can be downloaded from [axis.com/support](http://axis.com/support)

For more information about how to find and assign IP addresses, see the document *How to assign an IP address and access your device on the device page* at [axis.com](http://axis.com)

### Access the device

1. Open a browser and enter the IP address or host name of the Axis device.  
  
If you have a Mac computer (OS X), go to Safari, click on Bonjour and select the device from the drop-down list. To add Bonjour as a browser bookmark, go to **Safari > Preferences**.  
  
If you do not know the IP address, use AXIS IP Utility or AXIS Device Manager to find the device on the network.
2. Enter the username and password. If you access the device for the first time, you must set the root password. See *Set a secure password for the root account on page 4*.
3. The live view page opens in your browser.

### About secure passwords

#### Important

Axis devices send the initially set password in clear text over the network. To protect your device after the first login, set up a secure and encrypted HTTPS connection and then change the password.

The device password is the primary protection for your data and services. Axis devices do not impose a password policy as they may be used in various types of installations.

To protect your data we strongly recommend that you:

- Use a password with at least 8 characters, preferably created by a password generator.
- Don't expose the password.
- Change the password at a recurring interval, at least once a year.

### Set a secure password for the root account

#### Important

The default administrator username is **root**. If the password for root is lost, reset the device to factory default settings.

1. Type a password. Follow the instructions about secure passwords. See *About secure passwords on page 4*.
2. Retype the password to confirm the spelling.
3. Click **Create login**. The password has now been configured.

# AXIS Q6215-LE PTZ Network Camera

## Setup

---

### Setup

### Webpage overview



- 1 Live view control bar
- 2 Live view
- 3 Product name
- 4 Controls
- 5 Video control bar
- 6 Settings toggle

# AXIS Q6215-LE PTZ Network Camera

## Setup

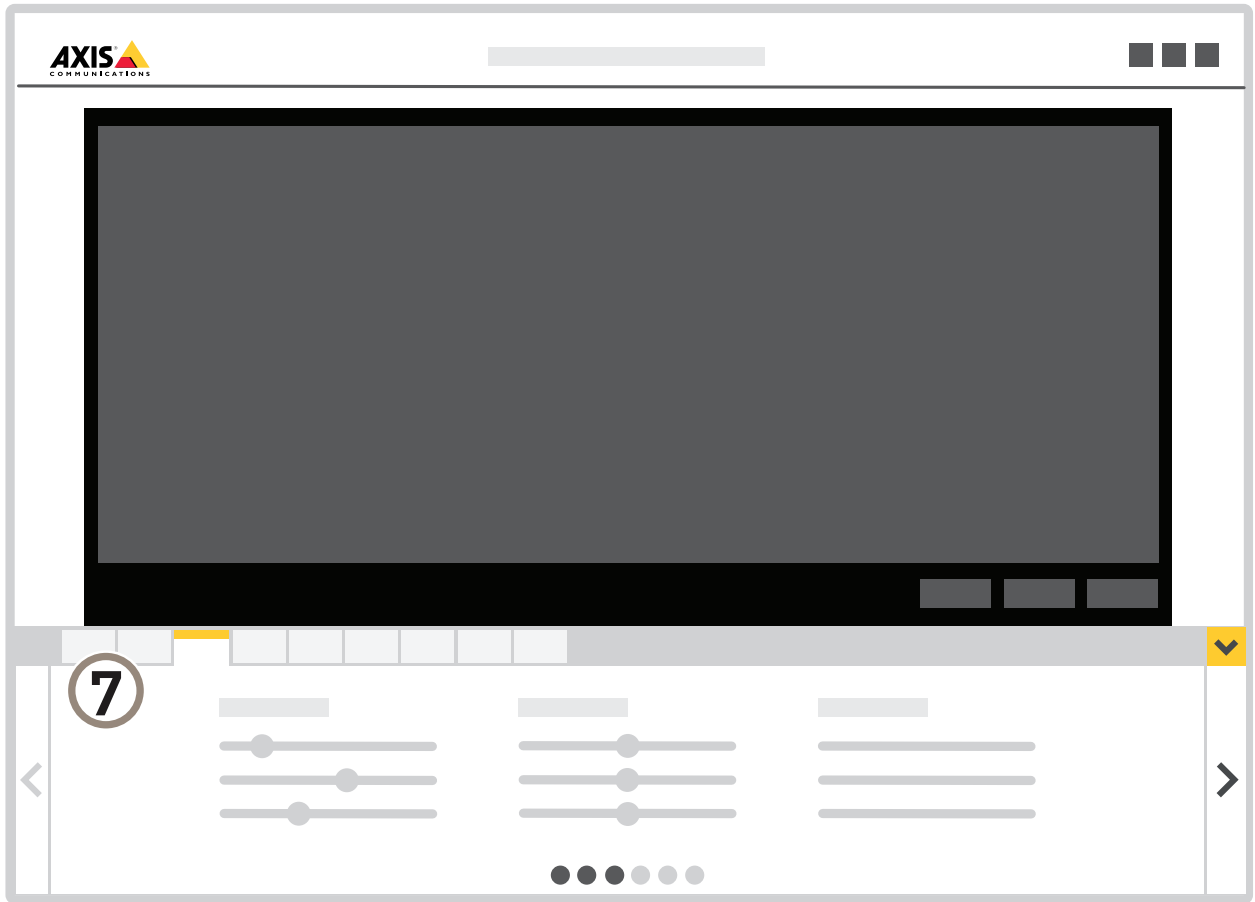

7 Settings tabs

### Need more help?

You can access the built-in help from the device's webpage. The help provides more detailed information on the device's features and their settings.

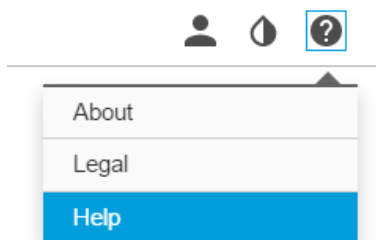

# AXIS Q6215-LE PTZ Network Camera

## Setup

---

### Image quality

#### Benefit from IR light in low-light conditions using night mode

Your camera uses visible light to deliver color images during the day. As the available light diminishes, you can set the camera to automatically shift to night mode, in which the camera uses both visible light and near-infrared light to deliver black-and-white images. Since the camera uses more of the available light it can deliver brighter, more detailed, images.

1. Go to **Settings > Image > Day and night**, and make sure that the **IR cut filter** is set to **Auto**.
2. To determine at what light level you want the camera to shift to night mode, set the **Day-night shift priority** to **Day**, **Night** or **None**.
3. Enable **Allow IR illumination** and **Synchronize IR illumination** to use the camera's IR light when night mode is activated.

#### Reduce motion blur in low-light conditions

To reduce motion blur in low-light conditions, you can adjust one or more of the following settings:

##### Note

Image noise will increase if you increase the gain.

- Increase shutter speed and gain. Go to **Settings > Image > Exposure** and set **Max shutter** to a shorter time, and **Max gain** to a higher value.

If you are still experiencing motion blur, you can try one of the following:

- Increase the light level in the scene.
- Mount the camera so that objects move toward it or away from it rather than sideways.

#### Handle scenes with strong backlight

Dynamic range is the difference in light levels in an image. In some cases the difference between the darkest and the brightest areas can be significant. The result is often an image where either the dark or the bright areas are visible. Wide dynamic range (WDR) makes both dark and bright areas of the image visible.

1. Go to **Settings > Image**.
2. If required, turn on WDR under **Wide dynamic range**.



*Image without WDR.*

# AXIS Q6215-LE PTZ Network Camera

## Setup

---



*Image with WDR.*

### Note

WDR may cause artifacts in the image.

Find out more about WDR and how to use it at [axis.com/web-articles/wdr](https://axis.com/web-articles/wdr)

### Remove water from the front glass with the wiper

The wiper is controlled manually.

1. Click on the Wiper button in the Live view control bar.

## Privacy masks

### Hide parts of the image with privacy masks

What is a privacy mask?

A privacy mask is a user-defined area that prevents users from viewing a part of the monitored area. In the video stream, privacy masks appear as blocks of solid color.

The privacy mask is relative to the pan, tilt, and zoom coordinates, so regardless of where you point the camera, the privacy mask covers the same place or object.

You'll see the privacy mask on all snapshots, recorded video, and live streams.

You can use the VAPIX® application programming interface (API) to turn off the privacy masks.

### Important

Using multiple privacy masks may affect the product's performance.

### Create a privacy mask

To create a privacy mask, go to **Settings > Privacy mask** .

## Overlays

### About overlays

Overlays are superimposed over the video stream. They are used to provide extra information during recordings, such as a timestamp, or during product installation and configuration.

### Show a text overlay in the video stream when the device detects motion

This example explains how to display the text "Motion detected" when the device detects motion:



# AXIS Q6215-LE PTZ Network Camera

## Setup

---

Make sure the AXIS Video Motion Detection application is running:

1. Go to **Settings > Apps > AXIS Video Motion Detection**.
2. Start the application if it is not already running.
3. Make sure you have set up the application according to your needs.

Add the overlay text:

4. Go to **Settings > Overlay**.
5. Enter #D in the text field.
6. Choose text size and appearance.

Create a rule:

7. Go to **System > Events > Rules** and add a rule.
8. Type a name for the rule.
9. In the list of conditions, select **AXIS Video Motion Detection**.
10. In the list of actions, select **Use overlay text**.
11. Select a view area.
12. Type "Motion detected".
13. Set the duration.
14. Click **Save**.

### Display the pan or tilt position as a text overlay

It may be useful to retrieve, for instance from a recorded video, the pan or tilt position in degrees in which an event has taken place. This can be obtained by including the position in the image as a text overlay, using a so-called modifier.

1. Go to **Settings > Overlay**.
2. In the text field, enter #x to show the pan position.  
Enter #y to show the tilt position.
3. Choose alignment, text size and appearance.
4. The current pan and tilt positions show up in the live view image and in the recording.

## PTZ (Pan Tilt Zoom)

### Limit the pan, tilt, and zoom movements

As an example, you might need to protect the privacy of residents living in apartment buildings located close to a parking lot that you wish to surveil. To do this, you can limit the pan, tilt, and zoom movements, so that the view does not cover the apartment buildings. Go to **Settings > PTZ > Limits**.

### About guard tours

A guard tour displays the video stream from different preset positions either in a predetermined or random order, and for configurable periods of time. Once started, a guard tour continues to run until stopped, even when there are no clients (web browsers) viewing the images.

# AXIS Q6215-LE PTZ Network Camera

## Setup



---

The guard tour function in this product includes tour recording. This allows recording a custom tour using an input device, such as a joystick, a mouse or a keyboard, or through using the VAPIX® Application Programming Interface (API). A recorded tour is a replay of a recorded sequence of pan/tilt/zoom movements, including their variable speeds and lengths.

### Create a guard tour with preset positions

1. Go to **Settings > PTZ > Guard tours**
2. Click **+**.
3. Select **Preset position**.
4. To edit the guard tour's properties, click 
5. Type a name for the guard tour and specify the pause length in minutes between each tour.
6. If you want the guard tour to go to the preset positions in a random order, turn on **Shuffle**.
7. Click **Done**.
8. Click **Add** to add the preset positions that you want in your guard tour.
9. Click **Done** to exit the guard tour settings.
10. To schedule the guard tour, go to **System > Events**.

### Create a recorded guard tour

1. Go to **Settings > PTZ > Guard tours**
2. Click **+**
3. Select **Recorded**.
4. To start recording the pan/tilt/zoom movements, click 
5. When you're satisfied, click 
6. If you re-record the guard tour you will overwrite the existing recorded guard tour.
7. To edit the guard tour's properties, click 
8. Type a name for the guard tour and specify the pause length in minutes between each tour.
9. Click **Done** twice to exit the guard tour settings.
10. To schedule the guard tour, go to **System > Events**.

## Streaming and storage

### Choose video compression format

Decide which compression method to use based on your viewing requirements, and on the properties of your network. The available options are:

H.264 or MPEG-4 Part 10/AVC

#### Note

H.264 is a licensed technology. The Axis product includes one H.264 viewing client license. Installing additional unlicensed copies of the client is prohibited. To purchase additional licenses, contact your Axis reseller.

# AXIS Q6215-LE PTZ Network Camera

## Setup

---

H.264 can, without compromising image quality, reduce the size of a digital video file by more than 80% compared to the Motion JPEG format and by as much as 50% compared to the MPEG-4 standard. This means that less network bandwidth and storage space are required for a video file. Or seen another way, higher video quality can be achieved for a given bitrate.

### Reduce bandwidth and storage

#### Important

If you reduce the bandwidth it can result in loss of details in the picture.

1. Go to live view and select **H.264**.
2. Go to **Settings > Stream**.
3. Do one or more of the following:
  - Turn on the Zipstream functionality and select the desired level.
  - Turn on dynamic GOP and set a high GOP length value.
  - Increase the compression.
  - Turn on dynamic FPS.

### Set up network storage

To store recordings on the network, you need to set up network storage:

1. Go to **Settings > System > Storage**.
2. Click **Setup** under **Network storage**.
3. Enter the IP address of the host server.
4. Enter the name of the shared location on the host server.
5. Move the switch if the share requires a login, and enter username and password.
6. Click **Connect**.

### Record and watch video

To record video you must first set up network storage, see *Set up network storage on page 11*, or have an SD card installed.

1. Go to the camera's live view.
2. Click on **Record** once to start recording and one more time to stop recording.

To watch your recording:

1. Click on **Storage > Go to recordings**.
2. Select your recording in the list and it will play automatically.

### Rules and alerts

You can create rules to make your device perform an action when certain events occur. A rule consists of conditions and actions. The conditions can be used to trigger the actions. For example, the device can start a recording or send an email when it detects motion, or show an overlay text when it records.

# AXIS Q6215-LE PTZ Network Camera

## Setup

---

### Trigger an action

1. Go to **Settings > System > Events** to set up a rule. The rule defines when the camera will perform certain actions. Rules can be setup as scheduled, recurring, or for example, triggered by motion detection.
2. Select the **Condition** that must be met to trigger the action. If you specify more than one condition for the rule, all of the conditions must be met to trigger the action.
3. Select which **Action** the camera should perform when the conditions are met.

#### Note

If you make changes to an active rule, then the rule needs to be restarted for the changes to take effect.

### Record video when the camera detects motion

This example explains how to set up the camera to start recording to the SD card five seconds before it detects motion and to stop one minute after.

Make sure the AXIS Video Motion Detection application is running:

1. Go to **Settings > Apps > AXIS Video Motion Detection**.
2. Start the application if it is not already running.
3. Make sure you have set up the application according to your needs.

Create a rule:

1. Go to **Settings > System > Events** and add a rule.
2. Type a name for the rule.
3. In the list of conditions, under **Application**, select **AXIS Video Motion Detection (VMD)**.
4. In the list of actions, under **Recordings**, select **Record video while the rule is active**.
5. Select an existing stream profile or create a new one.
6. Set the prebuffer time to 5 seconds.
7. Set the postbuffer time to 60 seconds.
8. In the list of storage options, select **SD card**.
9. Click **Save**.

### Direct the camera to a preset position when the camera detects motion

This example explains how to set up the camera to go to a preset position when it detects motion in the image.

Make sure the AXIS Video Motion Detection application is running:

1. Go to **Settings > Apps > AXIS Video Motion Detection**.
2. Start the application if it is not already running.
3. Make sure you have set up the application according to your needs.

Add a preset position:

Go to **Settings > PTZ** and set where you want the camera to be directed by creating a preset position.

Create a rule:

1. Go to **Settings > System > Events > Rules** and add a rule.

# AXIS Q6215-LE PTZ Network Camera

## Setup

---

2. Type a name for the rule.
3. In the list of conditions, select a video motion detection condition under **Application**.
4. From the list of actions, select **Go to preset position**.
5. Select the preset position you want the camera to go to.
6. Click **Save**.

### Zoom in on a specific area automatically with gatekeeper

This example explains how to use the gatekeeper functionality to make the camera zoom in automatically on the license plate of a car that passes through a gate. When the car has passed, the camera zooms out to the home position.

Create the preset positions:

1. Go to **Settings > PTZ > Preset positions**.
2. Create the home position that includes the entrance of the gate.
3. Create the zoomed-in preset position so that it covers the area in the image where you assume that the license plate will appear.

Create a motion detection profile:

1. Go to **Settings > Apps** and open **AXIS Video Motion Detection**.
2. Create a profile that covers the entrance of the gate and then save the profile.

Create a rule:

1. Go to **Settings > System > Events** and add a rule.
2. Name the rule "Gatekeeper".
3. In the list of conditions, under **Application**, select the motion detection profile.
4. In the list of actions, under **Preset positions**, select **Go to preset position**.
5. Select a **Video channel**.
6. Select the **Preset position**.
7. To make the camera wait a while before it returns to the home position, select **Home timeout**, and set a time.
8. Click **Save**.

### Record video when the camera detects impact

Shock detection allows the camera to detect tampering caused by vibrations or shock. Vibrations due to the environment or to an object can trigger an action depending on the shock sensitivity range, which can be set from 0 to 100. In this scenario, someone is throwing rocks at the camera after hours and you would like to get a video clip of the event.

Turn on shock detection:

1. Go to **Settings > System > Detectors**.
2. Turn on shock detection, and set a value for the shock sensitivity.

Create a rule:

1. Go to **Settings > System > Events** and add a rule.
2. Type a name for the rule.

# AXIS Q6215-LE PTZ Network Camera

## Setup

---

3. In the list of conditions, under **Device status**, select **Shock detected**.
4. Click **+** to add a second condition.
5. In the list of conditions, under **Scheduled and recurring**, select **Scheduled event**.
6. In the list of schedules, select **After hours**.
7. In the list of actions, under **Recordings**, select **Record video while the rule is active**.
8. Select a **Camera**.
9. Set the prebuffer time to 5 seconds.
10. Set the postbuffer time to 60 seconds.
11. Select where to save the recordings.
12. Click **Save**.

## Applications

AXIS Camera Application Platform (ACAP) is an open platform that enables third parties to develop analytics and other applications for Axis products. To find out more about available applications, downloads, trials and licenses, go to [axis.com/applications](https://axis.com/applications)

To find the user manuals for Axis applications, go to [axis.com](https://axis.com)

### Note

- Several applications can run at the same time but some applications might not be compatible with each other. Certain combinations of applications might require too much processing power or memory resources when run in parallel. Verify that the applications work together before deployment.

# AXIS Q6215-LE PTZ Network Camera

## Troubleshooting

---

### Troubleshooting

If you can't find what you're looking for here, try the troubleshooting section at [axis.com/support](https://axis.com/support)

### Reset to factory default settings

#### Important

Reset to factory default should be used with caution. A reset to factory default resets all settings, including the IP address, to the factory default values.

To reset the product to the factory default settings:

1. Disconnect power from the product.
2. Press and hold the control button while reconnecting power. See *Product overview on page 3*.
3. Keep the control button pressed for 15–30 seconds until the status LED indicator flashes amber.
4. Release the control button. The process is complete when the status LED indicator turns green. The product has been reset to the factory default settings. If no DHCP server is available on the network, the default IP address is 192.168.0.90
5. Use the installation and management software tools to assign an IP address, set the password, and access the video stream.

The installation and management software tools are available from the support pages on [axis.com/support](https://axis.com/support)

It is also possible to reset parameters to factory default through the web interface. Go to **Settings > System > Maintenance** and click **Default**.

### Check the current firmware

Firmware is the software that determines the functionality of network devices. One of your first actions when troubleshooting a problem should be to check the current firmware version. The latest version may contain a correction that fixes your particular problem.

To check the current firmware:

1. Go to the product's webpage.
2. Click on the help menu. 
3. Click **About**.

### Upgrade the firmware

#### Important

Preconfigured and customized settings are saved when the firmware is upgraded (provided that the features are available in the new firmware) although this is not guaranteed by Axis Communications AB.

#### Important

Make sure the product remains connected to the power source throughout the upgrade process.

#### Note

When you upgrade the product with the latest firmware in the active track, the product receives the latest functionality available. Always read the upgrade instructions and release notes available with each new release before upgrading the firmware. To find the latest firmware and the release notes, go to [axis.com/support/firmware](https://axis.com/support/firmware)

# AXIS Q6215-LE PTZ Network Camera

## Troubleshooting

---

1. Download the firmware file to your computer, available free of charge at [axis.com/support/firmware](https://axis.com/support/firmware)
2. Log in to the product as an administrator.
3. Go to **Settings > System > Maintenance**. Follow the instructions on the page. When the upgrade has finished, the product restarts automatically.

AXIS Device Manager can be used for multiple upgrades. Find out more at [axis.com/products/axis-device-manager](https://axis.com/products/axis-device-manager)

### Technical issues, clues and solutions

If you can't find what you're looking for here, try the troubleshooting section at [axis.com/support](https://axis.com/support)

#### Problems upgrading the firmware

---

**Firmware upgrade failure** If the firmware upgrade fails, the device reloads the previous firmware. The most common reason is that the wrong firmware file has been uploaded. Check that the name of the firmware file corresponds to your device and try again.

#### Problems setting the IP address

---

**The device is located on a different subnet** If the IP address intended for the device and the IP address of the computer used to access the device are located on different subnets, you cannot set the IP address. Contact your network administrator to obtain an IP address.

**The IP address is being used by another device** Disconnect the Axis device from the network. Run the ping command (in a Command/DOS window, type `ping` and the IP address of the device):

- If you receive: `Reply from <IP address>: bytes=32; time=10...` this means that the IP address may already be in use by another device on the network. Obtain a new IP address from the network administrator and reinstall the device.
- If you receive: `Request timed out`, this means that the IP address is available for use with the Axis device. Check all cabling and reinstall the device.

**Possible IP address conflict with another device on the same subnet** The static IP address in the Axis device is used before the DHCP server sets a dynamic address. This means that if the same default static IP address is also used by another device, there may be problems accessing the device.

#### The device cannot be accessed from a browser

---

**Cannot log in** When HTTPS is enabled, ensure that the correct protocol (HTTP or HTTPS) is used when attempting to log in. You may need to manually type `http` or `https` in the browser's address field.

If the password for the user `root` is lost, the device must be reset to the factory default settings. See *Reset to factory default settings on page 15*.

**The IP address has been changed by DHCP** IP addresses obtained from a DHCP server are dynamic and may change. If the IP address has been changed, use AXIS IP Utility or AXIS Device Manager to locate the device on the network. Identify the device using its model or serial number, or by the DNS name (if the name has been configured).

If required, a static IP address can be assigned manually. For instructions, go to [axis.com/support](https://axis.com/support)

#### The device is accessible locally but not externally

---

To access the device externally, we recommend using one of the following applications for Windows®:

- AXIS Companion: free of charge, ideal for small systems with basic surveillance needs.
- AXIS Camera Station: 30-day trial version free of charge, ideal for small to mid-size systems.

For instructions and download, go to [axis.com/products/axis-companion](https://axis.com/products/axis-companion)



# AXIS Q6215-LE PTZ Network Camera

## Troubleshooting

---

### Problems with streaming

---

Multicast H.264 only accessible by local clients	Check if your router supports multicasting, or if the router settings between the client and the device need to be configured. The TTL (Time To Live) value may need to be increased.
No multicast H.264 displayed in the client	Check with your network administrator that the multicast addresses used by the Axis device are valid for your network.  Check with your network administrator to see if there is a firewall preventing viewing.
Poor rendering of H.264 images	Ensure that your graphics card is using the latest driver. The latest drivers can usually be downloaded from the manufacturer's website.
Color saturation is different in H.264 and Motion JPEG	Modify the settings for your graphics adapter. Go to the adapter's documentation for more information.
Lower frame rate than expected	<ul style="list-style-type: none"><li>• See <i>Performance considerations on page 17</i>.</li><li>• Reduce the number of applications running on the client computer.</li><li>• Limit the number of simultaneous viewers.</li><li>• Check with the network administrator that there is enough bandwidth available.</li><li>• Lower the image resolution.</li><li>• Log in to the device's webpage and set a capture mode that prioritizes frame rate. Changing the capture mode to prioritize frame rate might lower the maximum resolution depending on the device used and capture modes available.</li><li>• The maximum frames per second is dependent on the utility frequency (60/50 Hz) of the Axis device.</li></ul>

### Performance considerations

When setting up your system, it is important to consider how various settings and situations affect the performance. Some factors affect the amount of bandwidth (the bitrate) required, others can affect the frame rate, and some affect both. If the load on the CPU reaches its maximum, this also affects the frame rate.

The following factors are the most important to consider:

- High image resolution or lower compression levels result in images containing more data which in turn affects the bandwidth.
- Rotating the lens manually will result in better performance compared to rotating the image from the GUI.
- Access by large numbers of Motion JPEG or unicast H.264 clients affects the bandwidth.
- Simultaneous viewing of different streams (resolution, compression) by different clients affects both frame rate and bandwidth.

Use identical streams wherever possible to maintain a high frame rate. Stream profiles can be used to ensure that streams are identical.

- Accessing Motion JPEG and H.264 video streams simultaneously affects both frame rate and bandwidth.
- Heavy usage of event settings affects the product's CPU load which in turn affects the frame rate.
- Using HTTPS may reduce frame rate, in particular if streaming Motion JPEG.
- Heavy network utilization due to poor infrastructure affects the bandwidth.
- Viewing on poorly performing client computers lowers perceived performance and affects frame rate.
- Running multiple AXIS Camera Application Platform (ACAP) applications simultaneously may affect the frame rate and the general performance.

# AXIS Q6215-LE PTZ Network Camera

## Specifications

---

### Specifications

To find the latest version of the product's datasheet, go to the product page at [axis.com](http://axis.com) and locate **Support & Documentation**.

### SD card slot

**NOTICE**

- Risk of damage to SD card. Do not use sharp tools, metal objects, or excessive force when inserting or removing the SD card. Use your fingers to insert and remove the card.
- Risk of data loss and corrupted recordings. Do not remove the SD card while the product is running. Unmount the SD card from the product's webpage before removal.

This product supports SD/SDHC/SDXC cards.

For SD card recommendations, see [axis.com](http://axis.com)



SD, SDHC, and SDXC Logos are trademarks of SD-3C LLC. SD, SDHC and SDXC are trademarks or registered trademarks of SD-3C, LLC in the United States, other countries or both.

### Buttons

#### Control button

The control button is used for:

- Resetting the product to factory default settings. See *Reset to factory default settings on page 15*.
- Connecting to an AXIS Video Hosting System service. To connect, press and hold the button for about 3 seconds until the status LED flashes green.

### Connectors

#### Network connector

RJ45 Push-pull Connector (IP66) with High Power over Ethernet (High PoE).

**NOTICE**

To comply with the IP66-rated design of the camera and maintain the IP66 protection, the supplied RJ45 Push-pull Connector (IP66) shall be used. Alternatively, use the RJ45 IP66-rated cable with premounted connector which is available from your Axis reseller. Do not remove the plastic network connector shield from the camera.

