

## **AXIS Q19 Series**

**AXIS Q1941-E Thermal Network Camera**

**AXIS Q1942-E Thermal Network Camera**

# AXIS Q19 Series

## Table of Contents

---

<b>Solution overview</b> .....	3
About perimeter protection .....	3
Product overview .....	4
<b>Find the device on the network</b> .....	5
Browser support .....	5
<b>Access the device</b> .....	6
Set a secure password for the root account .....	6
Secure passwords .....	6
<b>Setup</b> .....	7
Webpage overview .....	7
Applications .....	8
How to connect a flashing beacon .....	9
How to connect a network horn speaker .....	10
Image quality .....	11
Streaming and storage .....	11
<b>Troubleshooting</b> .....	14
Reset to factory default settings .....	14
Firmware options .....	14
Check the current firmware .....	14
Upgrade the firmware .....	15
Technical issues, clues and solutions .....	15
Performance considerations .....	16
<b>Specifications</b> .....	18
LED Indicators .....	18
SD card slot .....	18
Buttons .....	18
Connectors .....	18

# AXIS Q19 Series

## Solution overview

### Solution overview

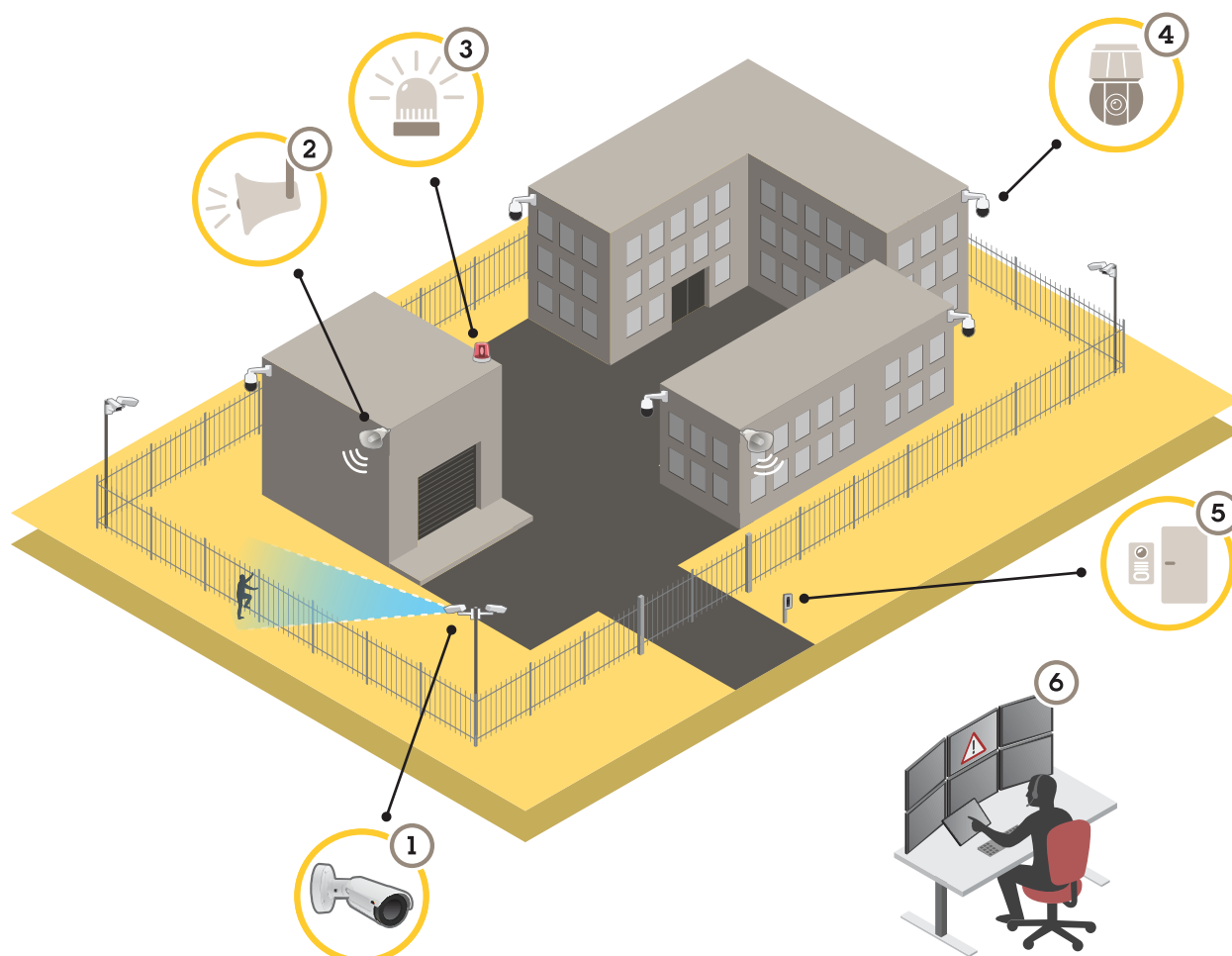

- 1 Thermal camera with AXIS Perimeter Defender
- 2 Horn speaker
- 3 Flashing beacon (not valid for PT Mount variants)
- 4 PTZ network camera
- 5 Door controller
- 6 Surveillance center

### About perimeter protection

For areas in need of intrusion detection, you can set up perimeter protection using thermal cameras with analytics. The main objective for perimeter protection is to detect a threat or an actual intrusion at the earliest possible stage.

To set up perimeter protection, you need to install an analytics application for perimeter surveillance and protection on your thermal camera. Axis provides the AXIS Perimeter Defender application for this purpose. You can read more about AXIS Perimeter Defender at [axis.com/products/axis-perimeter-defender](https://axis.com/products/axis-perimeter-defender)

# AXIS Q19 Series

## Solution overview

---

- To let possible intruders know that your perimeter is protected, use a flashing beacon (3). See *How to connect a flashing beacon on page 9*.
- To warn and deter, connect a horn speaker (2) that plays a pre-recorded warning message. See *How to connect a network horn speaker on page 10*.

## Product overview

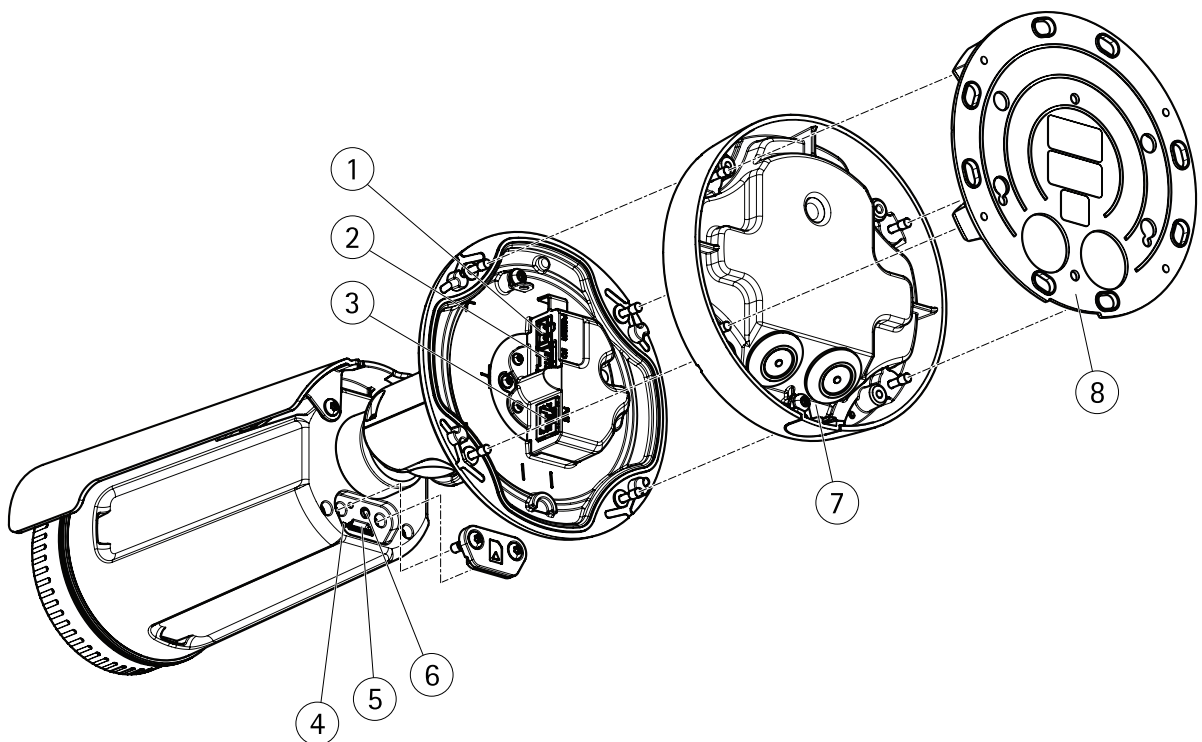

- 1 Power connector
- 2 I/O and audio terminal connector (multi-connector)
- 3 Network connector
- 4 Status indicator LED
- 5 MicroSD memory card slot
- 6 Control button
- 7 Foot
- 8 Mounting bracket

# AXIS Q19 Series

## Find the device on the network

---

### Find the device on the network

To find Axis devices on the network and assign them IP addresses in Windows®, use AXIS IP Utility or AXIS Device Manager. Both applications are free and can be downloaded from [axis.com/support](http://axis.com/support).

For more information about how to find and assign IP addresses, see the document *How to assign an IP address and access your device* on the device page at [axis.com](http://axis.com).

### Browser support

You can use the device with the following browsers:

	Chrome™	Firefox®	Edge®	Safari®
Windows®	recommended	x	x	
OS X®	recommended			x
Other operating systems	x	x		

If you need more information about recommended browsers, go to [axis.com/browser-support](http://axis.com/browser-support).

# AXIS Q19 Series

## Access the device

---

### Access the device

1. Open a browser and enter the IP address or host name of the Axis device.

If you have a Mac computer (OS X), go to Safari, click Bonjour and select the device from the drop-down list. To add Bonjour as a browser bookmark, go to **Safari > Preferences**.

If you do not know the IP address, use AXIS IP Utility or AXIS Device Manager to find the device on the network.

2. Enter the username and password. If you access the device for the first time, you must set the root password. See *Set a secure password for the root account on page 6*.
3. The live view page opens in your browser.

### Set a secure password for the root account

#### Important

The default administrator username is **root**. If the password for root is lost, reset the device to factory default settings.

1. Type a password. Follow the instructions about secure passwords. See *Secure passwords on page 6*.
2. Retype the password to confirm the spelling.
3. Click **Create login**. The password has now been configured.

### Secure passwords

#### Important

Axis devices send the initially set password in clear text over the network. To protect your device after the first login, set up a secure and encrypted HTTPS connection and then change the password.

The device password is the primary protection for your data and services. Axis devices do not impose a password policy as they may be used in various types of installations.

To protect your data we strongly recommend that you:

- Use a password with at least 8 characters, preferably created by a password generator.
- Don't expose the password.
- Change the password at a recurring interval, at least once a year.

# AXIS Q19 Series

## Setup

---

### Setup

### Webpage overview



- 1 Live view control bar
- 2 Live view
- 3 Product name
- 4 User information, color themes, and help
- 5 Video control bar
- 6 Settings toggle

# AXIS Q19 Series

## Setup

---

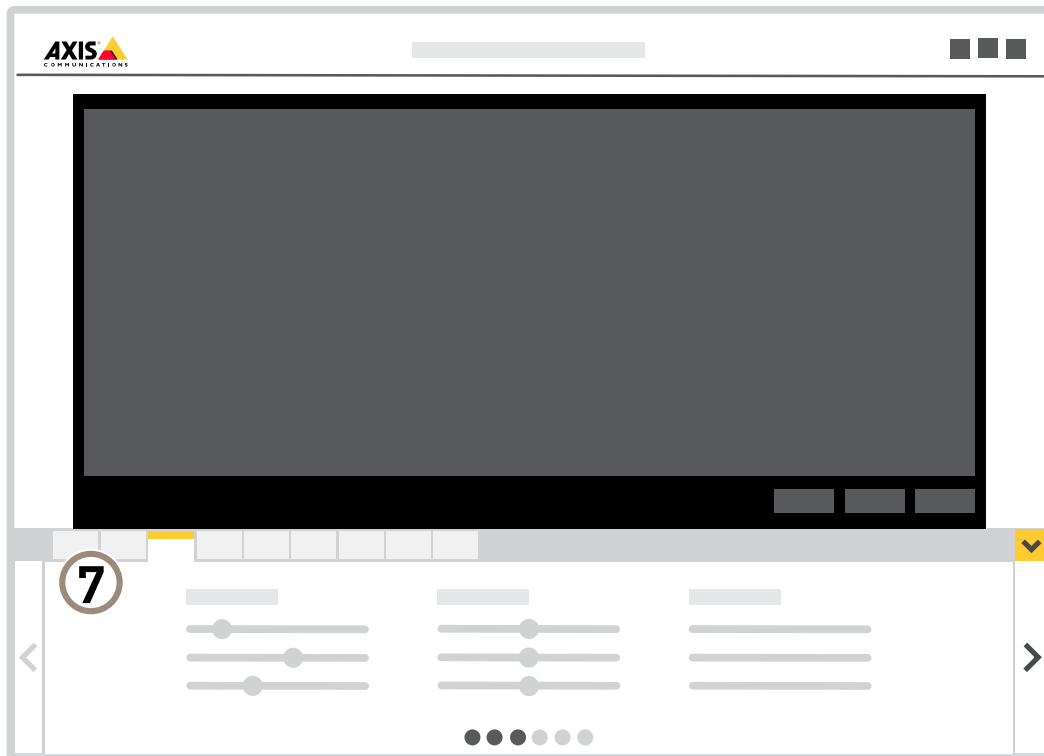

7 Settings tabs

### Need more help?

You can access the built-in help from the device's webpage. The help provides more detailed information on the device's features and their settings.

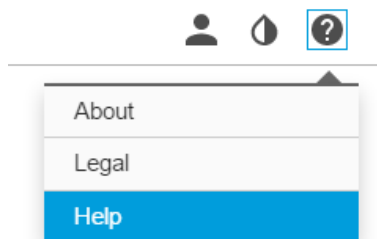

### Applications

AXIS Camera Application Platform (ACAP) is an open platform that enables third parties to develop analytics and other applications for Axis products. To find out more about available applications, downloads, trials and licenses, go to [axis.com/applications](https://axis.com/applications).

To find the user manuals for Axis applications, go to [axis.com](https://axis.com).



## Setup

### Note

- Several applications can run at the same time but some applications might not be compatible with each other. Certain combinations of applications might require too much processing power or memory resources when run in parallel. Verify that the applications work together before deployment.

## How to connect a flashing beacon

Use a flashing beacon to let possible intruders know that your perimeter is protected.

This scenario explains how to connect a flashing beacon and set it up to flash whenever the thermal camera detects an intrusion. In this scenario the beacon can only be activated to flash due to alarms outside office hours, between 18.00 and 08.00 Monday-Friday, and it should flash for 30 seconds each time it is activated.

### Required hardware

- Multicable, see *Multiconnector on page 19*
- Connecting wires (one blue and one red, min area: 0.25 mm<sup>2</sup>, max area: 0.5 mm<sup>2</sup>)
- Flashing beacon (12 V DC, max 50 mA)

### Note

The maximum length of the connecting wires depends on the wire area and the power consumption of the beacon.

### Physical connection

1. Connect the multicable to the camera.
2. Connect the red wire to pin 2 (DC output, +12 V DC) of the multicable I/O terminal connector.
3. Connect the other end of the red wire to the connector marked with + on the flashing beacon.
4. Connect the blue wire to pin 3 (I/O port) of the multicable I/O terminal connector.
5. Connect the other end of the blue wire to the connector marked with – on the flashing beacon.

### Configure I/O ports

You need to connect the flashing beacon to the camera in the camera's webpage. The first part of this is to configure the I/O ports.

1. Go to **System > I/O ports**.

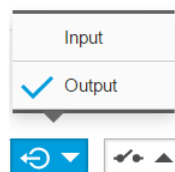

2. In the **Port 1** drop-down list, select **Output**.
3. Enter a name for the output module, for example "Flashing beacon".

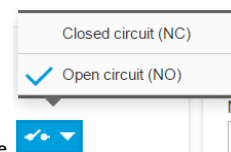

4. To make the beacon start flashing when an event occurs, select **Open circuit** in the **Port 1** drop-down list.

### Create an action rule

For the camera to send a notification to the beacon to start flashing when something is detected, you need to create an action rule in the camera.

# AXIS Q19 Series

## Setup

---

1. Go to **Settings > System > Events** and add a rule.
2. Enter a name, for example "Flashing beacon".
3. In the list of conditions, select the perimeter defender application.
4. Select **Use this condition as a trigger**.
5. Add another condition.
6. In the list of conditions, select **Scheduled event**.
7. In the list of schedules, select **After hours**.
8. In the list of actions, select **Output port**.
9. In the port list, select "Flashing beacon".
10. Set the duration to 30 seconds.
11. Click **Save**.

## How to connect a network horn speaker

Use a network horn speaker to warn and deter possible intruders.

This scenario explains how to connect an Axis network horn speaker to the camera and set it up to play an audio clip whenever the thermal camera detects an intrusion. In this scenario, the horn speaker can only be activated due to alarms coming outside office hours, between 18.00 and 08.00 Monday-Friday.

### Add a recipient

#### Note

An audio clip must be available in the horn speaker and you need to know the number of the audio clip. To find out the number of the audio clip, type the following command: `http://[HornSpeakerIP]/axis-cgi/param.cgi?action=list`, where `[HornSpeakerIP]` is the IP address of the horn speaker. You find the number after the letter M in the list displayed.

Connect the camera to the horn speaker by setting it up as a recipient in the camera.

1. Go to **Settings > System > Events > Recipients** and add a recipient.
2. Enter a name, for example "Horn speaker".
3. In the **Type** list, select **HTTP**.
4. In the **URL** field, enter `http://[HornSpeakerIP]/axis-cgi/playclip.cgi?clip=[x]`.
  - `[HornSpeakerIP]` is the IP address of the horn speaker
  - `[x]` is the audio clip number
5. Enter the username and password for the horn speaker.
6. To try the connection, click **Test**.

### Create a rule

For the camera to send a notification to the horn speaker to play the audio clip when something is detected, you need to create a rule in the camera.

1. Go to **Settings > System > Events** and add a rule.
2. Enter a name, for example "Horn speaker".

# AXIS Q19 Series

## Setup

---

3. In the list of conditions, select the perimeter defender application.
4. Select **Use this condition as a trigger**.
5. Add another condition.
6. In the list of conditions, select **Scheduled event**.
7. In the list of schedules, select **After hours**.
8. In the list of actions, select **Send notification through HTTP** and then select **Horn speaker**.
9. Click **Save**.

## Image quality

### Color palettes

Color palettes applied to thermal images help the human eye distinguish image details. The colors in the palette are artificially created pseudocolors that emphasize temperature differences.

The product has several color palettes to choose from. If an operator watches the video stream, you can choose any of the palettes. If the video stream is only used by applications, select the white-hot palette.

### Stabilize a shaky image with Electronic Image Stabilization (EIS)

Electronic Image Stabilization (EIS) can be used in environments where the product is mounted in an exposed location and subject to vibrations, for example, wind or passing traffic. Turn on EIS to get a smoother and steadier image without blur.

EIS also reduces the file size of the compressed image and lowers the bitrate of the video stream.

#### Note

When EIS is turned on the image is cropped slightly, lowering the maximum resolution.

1. Go to **Settings > Image > Image correction**.
2. Turn on EIS.

## Streaming and storage

### Bitrate control

By setting the bitrate control you can manage the bandwidth consumption for your video stream.

#### Variable bitrate (VBR)

With variable bitrate the bandwidth varies based on the level of activity in the scene. The more activity in the scene, the more bandwidth is required. This option guarantees that image quality is constant but requires storage margins.

## Setup

---

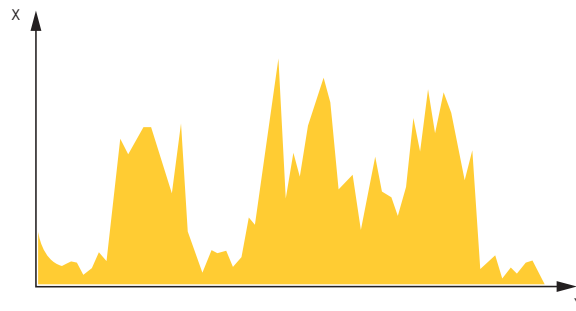

X Bitrate  
Y Time

### Maximum bitrate (MBR)

The maximum bitrate option allows you to set a target bitrate value to be able to handle system bitrate limitations. To keep the instantaneous bitrate below the specified target bitrate, there may be a decrease in image quality or the frame rate may decrease. You have the option to prioritize either image quality or frame rate. It is recommended to configure the target bitrate higher than the expected bitrate to have margins for additional complexity that needs to be captured.

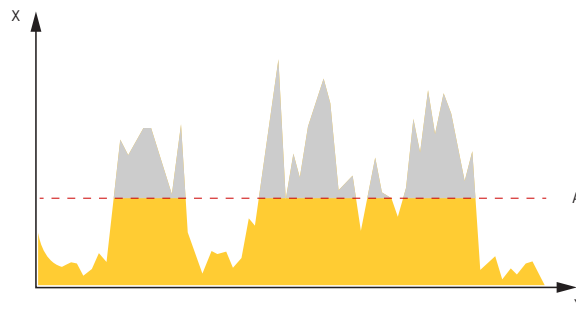

X Bitrate  
Y Time  
A Target bitrate

### Average bitrate (ABR)

With average bitrate, the bitrate is automatically adjusted over a longer timescale to meet the specified target and provide the best quality on the video stream based on available storage. Bitrate is higher in scenes with activities, compared to static scenes. The probability of getting better image quality when desired is higher when using the average bitrate option. The average bitrate option allows you to define the total storage required to store the video stream for a specified amount of time (retention time) when image quality is adjusted to meet the specified target bitrate. Specify the average bitrate settings in one of the following ways:

- Set the target bitrate and the retention time to calculate the estimated storage need.
- Use the target bitrate calculator to calculate the average bitrate, based on available storage and desired retention time.

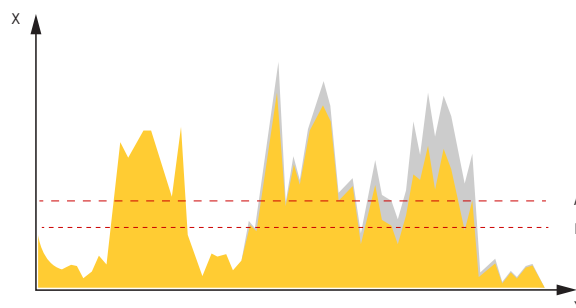

# AXIS Q19 Series

## Setup

---

You have also the option to turn on maximum bitrate to specify a bitrate limit.

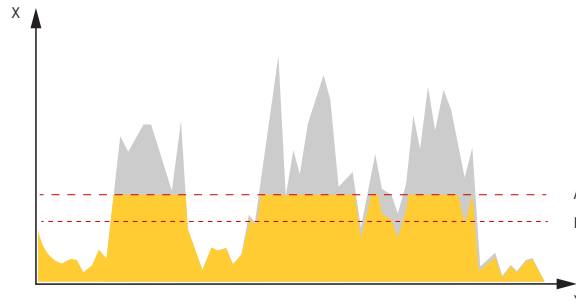

*X* Bitrate  
*Y* Time  
*A* Target bitrate  
*B* Actual average bitrate

### Reduce bandwidth and storage

#### Important

If you reduce the bandwidth it can result in loss of details in the picture.

1. Go to live view and select **H.264**.
2. Go to **Settings > Stream**.
3. Do one or more of the following:
  - Turn on the Zipstream functionality and select the desired level.
  - Turn on dynamic GOP and set a high GOP length value.
  - Increase the compression.
  - Turn on dynamic FPS.

### Set up network storage

To store recordings on the network, you need to set up network storage:

1. Go to **Settings > System > Storage**.
2. Click **Setup** under **Network storage**.
3. Enter the IP address of the host server.
4. Enter the name of the shared location on the host server.
5. Move the switch if the share requires a login, and enter username and password.
6. Click **Connect**.

### Troubleshooting

If you can't find what you're looking for here, try the troubleshooting section at [axis.com/support](https://axis.com/support).

### Reset to factory default settings

#### Important

Reset to factory default should be used with caution. A reset to factory default resets all settings, including the IP address, to the factory default values.

To reset the product to the factory default settings:

1. Disconnect power from the product.
2. Press and hold the control button while reconnecting power. See *Product overview on page 4*.
3. Keep the control button pressed for 15–30 seconds until the status LED indicator flashes amber.
4. Release the control button. The process is complete when the status LED indicator turns green. The product has been reset to the factory default settings. If no DHCP server is available on the network, the default IP address is 192.168.0.90.
5. Use the installation and management software tools to assign an IP address, set the password, and access the video stream.

The installation and management software tools are available from the support pages on [axis.com/support](https://axis.com/support).

It is also possible to reset parameters to factory default through the web interface. Go to **Settings > System > Maintenance** and click **Default**.

### Firmware options

Axis offers product firmware management according to either the active track or the long-term support (LTS) tracks. Being on the active track means continuously getting access to all the latest product features, while the LTS tracks provide a fixed platform with periodic releases focused mainly on bug fixes and security updates.

Using firmware from the active track is recommended if you want to access the newest features, or if you use Axis end-to-end system offerings. The LTS tracks are recommended if you use third-party integrations, which are not continuously validated against the latest active track. With LTS, the products can maintain cybersecurity without introducing any significant functional changes or affecting any existing integrations. For more detailed information about Axis product firmware strategy, go to [axis.com/support/firmware](https://axis.com/support/firmware).

### Check the current firmware

Firmware is the software that determines the functionality of network devices. One of your first actions when troubleshooting a problem should be to check the current firmware version. The latest version may contain a correction that fixes your particular problem.

To check the current firmware:

1. Go to the product's webpage.
2. Click on the help menu. 
3. Click **About**.

### Upgrade the firmware

#### Important

Preconfigured and customized settings are saved when the firmware is upgraded (provided that the features are available in the new firmware) although this is not guaranteed by Axis Communications AB.

#### Important

Make sure the product remains connected to the power source throughout the upgrade process.

#### Note

When you upgrade the product with the latest firmware in the active track, the product receives the latest functionality available. Always read the upgrade instructions and release notes available with each new release before upgrading the firmware. To find the latest firmware and the release notes, go to [axis.com/support/firmware](https://axis.com/support/firmware).

1. Download the firmware file to your computer, available free of charge at [axis.com/support/firmware](https://axis.com/support/firmware).
2. Log in to the product as an administrator.
3. Go to **Settings > System > Maintenance**. Follow the instructions on the page. When the upgrade has finished, the product restarts automatically.

AXIS Device Manager can be used for multiple upgrades. Find out more at [axis.com/products/axis-device-manager](https://axis.com/products/axis-device-manager).

### Technical issues, clues and solutions

If you can't find what you're looking for here, try the troubleshooting section at [axis.com/support](https://axis.com/support).

#### Problems upgrading the firmware

---

Firmware upgrade failure	If the firmware upgrade fails, the device reloads the previous firmware. The most common reason is that the wrong firmware file has been uploaded. Check that the name of the firmware file corresponds to your device and try again.
--------------------------	---

#### Problems setting the IP address

---

The device is located on a different subnet	If the IP address intended for the device and the IP address of the computer used to access the device are located on different subnets, you cannot set the IP address. Contact your network administrator to obtain an IP address.
---	---

The IP address is being used by another device	Disconnect the Axis device from the network. Run the ping command (in a Command/DOS window, type <code>ping</code> and the IP address of the device): <ul style="list-style-type: none"><li>• If you receive: <code>Reply from &lt;IP address&gt;: bytes=32; time=10...</code> this means that the IP address may already be in use by another device on the network. Obtain a new IP address from the network administrator and reinstall the device.</li><li>• If you receive: <code>Request timed out</code>, this means that the IP address is available for use with the Axis device. Check all cabling and reinstall the device.</li></ul>
--	--

Possible IP address conflict with another device on the same subnet	The static IP address in the Axis device is used before the DHCP server sets a dynamic address. This means that if the same default static IP address is also used by another device, there may be problems accessing the device.
---	---

#### The device cannot be accessed from a browser

---

Cannot log in	When HTTPS is enabled, ensure that the correct protocol (HTTP or HTTPS) is used when attempting to log in. You may need to manually type <code>http</code> or <code>https</code> in the browser's address field.
---------------	--

If the password for the user `root` is lost, the device must be reset to the factory default settings. See *Reset to factory default settings on page 14*.

# AXIS Q19 Series

## Troubleshooting

---

The IP address has been changed by DHCP	IP addresses obtained from a DHCP server are dynamic and may change. If the IP address has been changed, use AXIS IP Utility or AXIS Device Manager to locate the device on the network. Identify the device using its model or serial number, or by the DNS name (if the name has been configured).  If required, a static IP address can be assigned manually. For instructions, go to <a href="http://axis.com/support">axis.com/support</a> .
Certificate error when using IEEE 802.1X	For authentication to work properly, the date and time settings in the Axis device must be synchronized with an NTP server. Go to <b>Settings &gt; System &gt; Date and time</b> .

### The device is accessible locally but not externally

---

To access the device externally, we recommend using one of the following applications for Windows®:

- AXIS Companion: free of charge, ideal for small systems with basic surveillance needs.
- AXIS Camera Station: 30-day trial version free of charge, ideal for small to mid-size systems.

For instructions and download, go to [axis.com/products/axis-companion](http://axis.com/products/axis-companion).

### Problems with streaming

---

Multicast H.264 only accessible by local clients	Check if your router supports multicasting, or if the router settings between the client and the device need to be configured. The TTL (Time To Live) value may need to be increased.
No multicast H.264 displayed in the client	Check with your network administrator that the multicast addresses used by the Axis device are valid for your network.  Check with your network administrator to see if there is a firewall preventing viewing.
Poor rendering of H.264 images	Ensure that your graphics card is using the latest driver. The latest drivers can usually be downloaded from the manufacturer's website.
Lower frame rate than expected	<ul style="list-style-type: none"><li>• See <i>Performance considerations on page 16</i>.</li><li>• Reduce the number of applications running on the client computer.</li><li>• Limit the number of simultaneous viewers.</li><li>• Check with the network administrator that there is enough bandwidth available.</li><li>• Lower the image resolution.</li><li>• The maximum frames per second is dependent on the utility frequency (60/50 Hz) of the Axis device.</li></ul>

## Performance considerations

When setting up your system, it is important to consider how various settings and situations affect the performance. Some factors affect the amount of bandwidth (the bitrate) required, others can affect the frame rate, and some affect both. If the load on the CPU reaches its maximum, this also affects the frame rate.

The following factors are the most important to consider:

- High image resolution or lower compression levels result in images containing more data which in turn affects the bandwidth.
- Rotating the image in the GUI will increase the product's CPU load.
- Access by large numbers of Motion JPEG or unicast H.264 clients affects the bandwidth.
- Simultaneous viewing of different streams (resolution, compression) by different clients affects both frame rate and bandwidth.

Use identical streams wherever possible to maintain a high frame rate. Stream profiles can be used to ensure that streams are identical.

- Accessing Motion JPEG and H.264 video streams simultaneously affects both frame rate and bandwidth.
- Heavy usage of event settings affects the product's CPU load which in turn affects the frame rate.



## AXIS Q19 Series

### Troubleshooting

---

- Using HTTPS may reduce frame rate, in particular if streaming Motion JPEG.
- Heavy network utilization due to poor infrastructure affects the bandwidth.
- Viewing on poorly performing client computers lowers perceived performance and affects frame rate.
- Running multiple AXIS Camera Application Platform (ACAP) applications simultaneously may affect the frame rate and the general performance.
- Using palettes affects the product's CPU load which in turn affects the frame rate.

# AXIS Q19 Series

## Specifications

---

### Specifications

To find the latest version of the product's datasheet, go to the product page at [axis.com](http://axis.com) and locate **Support & Documentation**.

### LED Indicators

Status LED	Indication
Unlit	Connection and normal operation.
Green	Connection and normal operation.
Amber	Steady during startup. Flashes during firmware upgrade or reset to factory default.
Amber/Red	Flashes amber/red if network connection is unavailable or lost.
Red	Firmware upgrade failure.

### SD card slot

#### NOTICE

- Risk of damage to SD card. Do not use sharp tools, metal objects, or excessive force when inserting or removing the SD card. Use your fingers to insert and remove the card.
- Risk of data loss and corrupted recordings. Do not remove the SD card while the product is running. Unmount the SD card from the product's webpage before removal.

This product supports microSD/microSDHC/microSDXC cards.

For SD card recommendations, see [axis.com](http://axis.com).



microSD, microSDHC, and microSDXC Logos are trademarks of SD-3C LLC. microSD, microSDHC, microSDXC are trademarks or registered trademarks of SD-3C, LLC in the United States, other countries or both.

### Buttons

#### Control button

For location of the control button, see *Product overview on page 4*.

The control button is used for:

- Resetting the product to factory default settings. See *page 14*.
- Connecting to an AXIS Video Hosting System service. See . To connect, press and hold the button for about 3 seconds until the Status LED flashes green.

### Connectors

#### Power connector

Terminal connector for connecting AC/DC power supply.

#### Network connector

RJ45 Ethernet connector with Power over Ethernet (PoE).

# AXIS Q19 Series

## Specifications

---

### Multiconnector

Terminal connector for connecting external equipment:

- Audio equipment
- Input/Output (I/O) devices
- DC power supply

When connecting external equipment, a separately sold Axis multicable is required in order to maintain the product's IP rating. For more information, see *Multicable connectors on page 19*.

### Multicable connectors

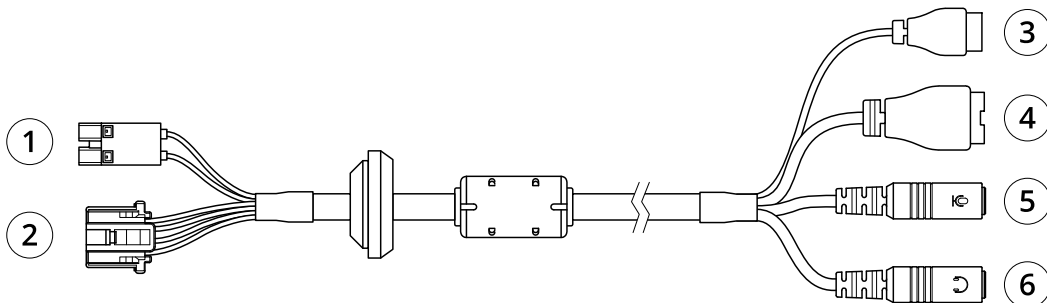

#### Multicable overview

- 1 Camera power connector
- 2 Camera multiconnector
- 3 Power connector
- 4 I/O terminal connector
- 5 Audio in (pink)
- 6 Audio out (green)

The multicable provides the following connectors:

**Power connector** – 2-pin terminal block used for power input. The polarity of the cables does not matter. Use a Safety Extra Low Voltage (SELV) compliant limited power source (LPS) with either a rated output power limited to  $\leq 100$  W or a rated output current limited to  $\leq 5$  A.



**Audio in (pink)** – 3.5 mm input for a mono microphone, or a line-in mono signal (left channel is used from a stereo signal).

**Audio out (green)** – 3.5 mm output for audio (line level) that can be connected to a public address (PA) system or an active speaker with a built-in amplifier. A stereo connector must be used for the audio out.

**I/O terminal connector** – Use with external devices in combination with, for example, tampering alarms, motion detection, event triggering, and alarm notifications. In addition to the 0 V DC reference point and power (DC output), the I/O connector provides the interface to:

- Digital output – For connecting external devices such as relays and LEDs. Connected devices can be activated by the VAPIX® Application Programming Interface or from the product's webpage.
- Digital input – For connecting external devices that can toggle between an open and closed circuit, for example PIR detectors, door/window contacts, and glass break detectors.

# AXIS Q19 Series

## Specifications

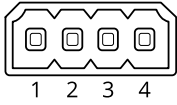

Function	Pin	Notes	Specifications
0 V DC (-)	1		0 V DC
DC output	2	Can be used to power auxiliary equipment. Note: This pin can only be used as power out.	12 V DC Max load =50 mA
Configurable (Input or Output)	3-4	Digital input – Connect to pin 1 to activate, or leave floating (unconnected) to deactivate.	0 to max 30 V DC
		Digital output – Internally connected to pin 1 (DC ground) when active, and floating (unconnected) when inactive. If used with an inductive load, e.g. a relay, a diode must be connected in parallel with the load, for protection against voltage transients.	0 to max 30 V DC, open drain, 100 mA

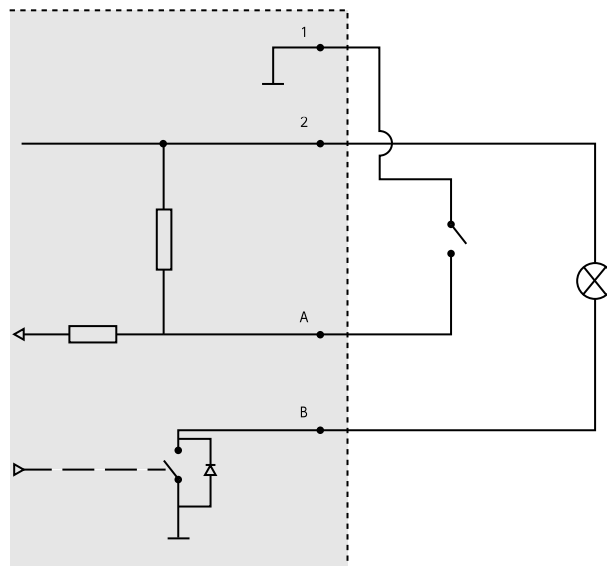

- 1 0 V DC (-)
- 2 DC output 12 V, max 50 mA
- A I/O configured as input
- B I/O configured as output

