

AXIS M30 Network Camera Series

AXIS M3057-PLVE

AXIS M3058-PLVE

User Manual

AXIS M30 Network Camera Series

Table of Contents

About this manual	3
Product overview	4
Find the device on the network	5
Access the device	5
About secure passwords	5
Setup	6
Product webpage overview	6
Image quality	8
Privacy masks	11
Overlays	11
PTZ (Pan Tilt Zoom)	12
Streaming and storage	13
Events	14
Applications	16
Troubleshooting	18
Reset to factory default settings	18
Check the current firmware	18
Upgrade the firmware	19
Technical issues, clues and solutions	19
Performance considerations	20
Specifications	22
LED indicators	22
SD card slot	22
Buttons	22
Connectors	22

AXIS M30 Network Camera Series

About this manual

About this manual

This user manual describes multiple products. Some of the instructions may not be relevant for your product.

AXIS M30 Network Camera Series

Product overview

Product overview

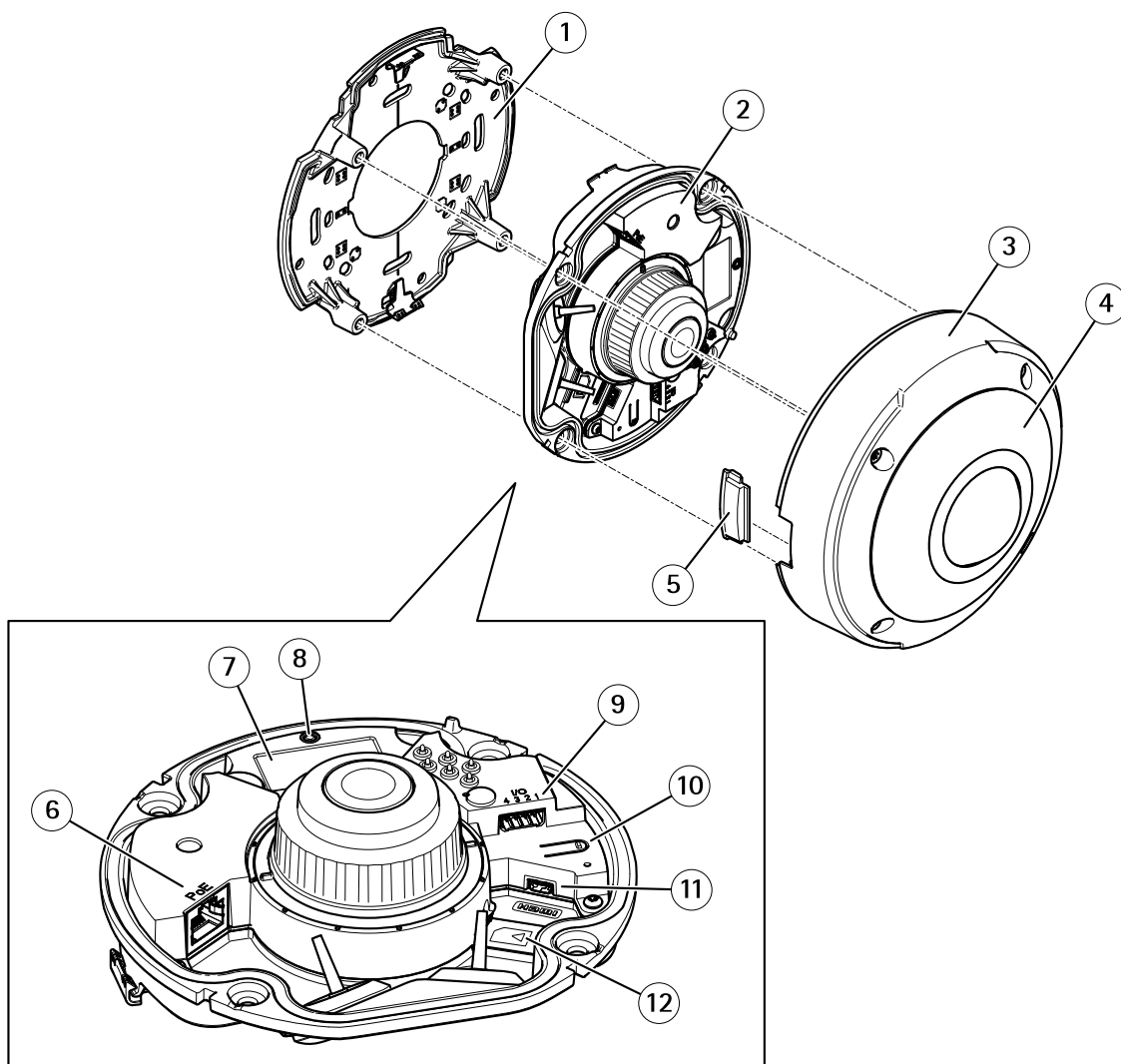

- 1 Mounting bracket
- 2 Camera unit
- 3 Cover
- 4 IR illumination
- 5 Lid
- 6 Network connector (PoE)
- 7 Part number (P/N) & Serial number (S/N)
- 8 Status LED indicator
- 9 I/O connector
- 10 Control button
- 11 HDMI connector
- 12 SD card slot

AXIS M30 Network Camera Series

Find the device on the network

Find the device on the network

To find Axis devices on the network and assign them IP addresses in Windows®, use AXIS IP Utility or AXIS Device Manager. Both applications are free and can be downloaded from axis.com/support

For more information about how to find and assign IP addresses, see the document *How to assign an IP address and access your device* on the device page at axis.com

Access the device

1. Open a browser and enter the IP address or host name of the Axis device.

If you have a Mac computer (OS X), go to Safari, click on Bonjour and select the device from the drop-down list. To add Bonjour as a browser bookmark, go to **Safari > Preferences**.

If you do not know the IP address, use AXIS IP Utility or AXIS Device Manager to find the device on the network.
2. Enter the username and password. If you access the device for the first time, you must set the root password. See *Set a secure password for the root account* on page 5.
3. The live view page opens in your browser.

About secure passwords

Important

Axis devices send the initially set password in clear text over the network. To protect your device after the first login, set up a secure and encrypted HTTPS connection and then change the password.

The device password is the primary protection for your data and services. Axis devices do not impose a password policy as they may be used in various types of installations.

To protect your data we strongly recommend that you:

- Change the default password that comes with each device.
- Use a password with at least 8 characters, preferably created by a password generator.
- Don't expose the password.
- Change the password at a recurring interval, at least once a year.

Set a secure password for the root account

Important

The default administrator username is **root**. If the password for root is lost, reset the device to factory default settings.

1. Type a password. Follow the instructions about secure passwords. See *About secure passwords* on page 5.
2. Retype the password to confirm the spelling.
3. Click **Create login**. The password has now been configured.

AXIS M30 Network Camera Series

Setup

Setup

Product webpage overview



- 1 *Live view control bar*
- 2 *Live view*
- 3 *Product name*
- 4 *Controls*
- 5 *Video control bar*
- 6 *Settings toggle*

AXIS M30 Network Camera Series

Setup

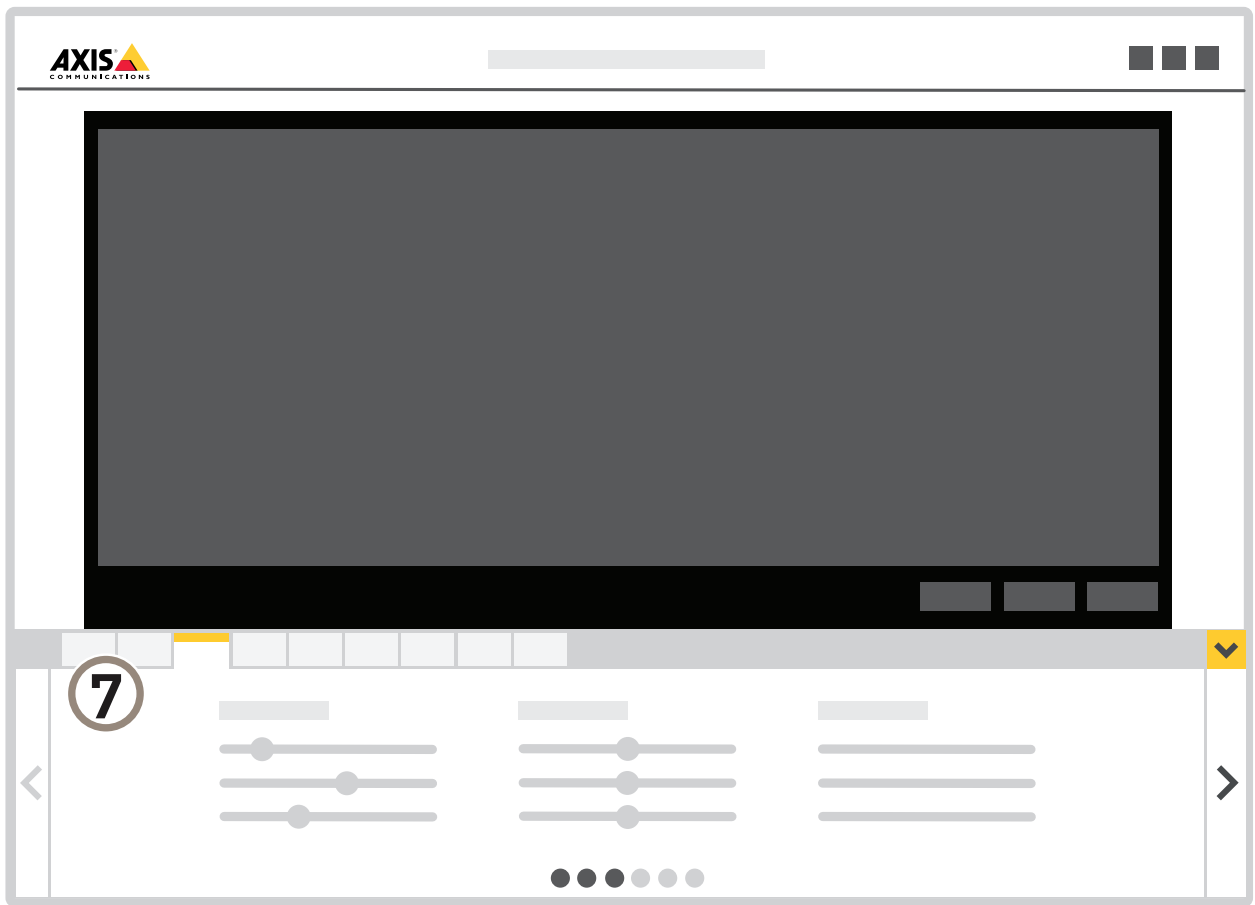

7 Settings tabs

About the product's built-in help

You can access the built-in help from the product's webpage. The help provides more detailed information on the product's features and their settings.

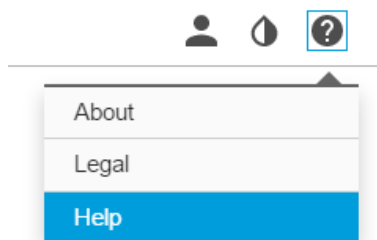

AXIS M30 Network Camera Series

Setup

Image quality









About capture modes

A capture mode is one of the possible views for this product and can be accessed from the drop-down list in the product's live stream view.

In the table below, you can see the highest and lowest available resolution for different views in each capture mode.

Note

One of the capture modes for these products only allow overview.

View	Symbol	Aspect ratio	Resolutions M3057-PLVE	Resolutions M3058-PLVE
Overview		1:1	2048x2048 to 160x160	2992x2992 to 160x160
Panorama		8:3 32:9	2560x960 to 192x72 2560x720 to 1280x360	3584x1344 to 192x72 3584x1008 to 1280x360
Double Panorama		4:3 16:9	2560x1920 to 320x240 2560x1440 to 256x144	3584x2668 to 320x240 3584x2016 to 256x144
Quad View		4:3 16:9	2560x1920 to 320x240 2560x1440 to 256x144	3584x2668 to 320x240 3584x2016 to 256x144
View Areas 1-4		4:3 16:9	1920x1440 to 320x240 2048x1152 to 256x144	2048x1536 to 320x240 2048x1152 to 256x144
Panorama Corner Left/Right		8:3 2:1	2304x864 to 192x72 2368x1184	3200x1200 to 192x72 3200x1600
Double Panorama Corner		4:3 1:1	1920x1440 to 320x240 2048x2048 to 480x480	2560x1920 to 320x240 2880x2880 to 480x480
Corridor		4:3 16:9	2560x1920 to 320x240 2560x1440 to 256x144	2560x1920 to 320x240 2560x1440 to 256x144

Select capture mode

Which capture mode to choose depends on the requirements of frame rate and resolution for the specific surveillance setup. For specifications about available capture modes, see the product's datasheet. To find the latest version of the datasheet, go to axis.com

Select exposure mode

There are different exposure mode options in the camera that adjusts aperture, shutter speed, and gain to improve image quality for specific surveillance scenes. Go to **Settings > Image > Exposure** and select between the following exposure modes:

- For most use cases, select **Automatic** exposure.
- For environments with certain artificial lighting, for example fluorescent lighting, select **Flicker-free**.
Select the same frequency as the power line frequency.
- For environments with certain artificial light and bright light, for example outdoors with fluorescent lighting at night and sun during daytime, select **Flicker-reduced**.

AXIS M30 Network Camera Series

Setup

Select the same frequency as the power line frequency.

- To lock the current exposure settings, select **Hold current**.

Optimize IR illumination

In most cases, the exposure of the image is automatically adjusted to obtain optimal image quality. Sometimes if the camera is placed close to a wall or a corner, it might result in saturating parts of the image. When this happens, the LED's closest to the wall or corner are automatically dimmed to avoid saturating the image.

Depending on the installation environment and the conditions around the camera, e.g. external light sources in the scene, it is sometimes possible to achieve better IR-illumination by manually setting the intensity of the LED's.

1. Go to **Settings > Image > Day and night**, and turn on **Allow IR illumination**.
2. Turn on **Live view control**.
3. Minimize **Settings**.
4. In the live view, click on **Illumination** and turn on **IR light** and **Manual intensity**.
5. Adjust **LED intensity**.

Benefit from IR light in low-light conditions using night mode

Your camera uses visible light to deliver color images during the day. As the available light diminishes, you can set the camera to automatically shift to night mode, in which the camera uses both visible light and near-infrared light to deliver black-and-white images. Since the camera uses more of the available light it can deliver brighter, more detailed, images.

1. Go to **Settings > Image > Day and night**, and make sure that the **IR cut filter** is set to **Auto**.

Reduce noise in low-light conditions

To reduce noise in low-light conditions, you can adjust one or more of the following settings:

- Make sure that the exposure mode is automatic.

Note

Increasing the max shutter value can result in motion blur.

- The shutter speed should be as slow as possible, which means you should set max shutter to the highest possible value.
- Reduce sharpness in the image.

Reduce motion blur in low-light conditions

To reduce motion blur in low-light conditions, you can adjust one or more of the following settings:

Note

Image noise will increase if you increase the gain.

- Increase shutter speed and gain. Go to **Settings > Image > Exposure** and set **Max shutter** to a shorter time, and **Max gain** to a higher value.

If you are still experiencing motion blur, you can try one of the following:

- Increase the light level in the scene.
- Mount the camera so that objects move toward it or away from it rather than sideways.

AXIS M30 Network Camera Series

Setup

Maximize details in an image

Important

If you maximize details in an image, the bitrate will probably increase and you might get a reduced frame rate.

- Set the compression as low as possible.
- Select MJPEG streaming.
- Turn off Zipstream functionality.

Handle scenes with strong backlight

Dynamic range is the difference in light levels in an image. In some cases the difference between the darkest and the brightest areas can be significant. The result is often an image where either the dark or the bright areas are visible. Wide dynamic range (WDR) makes both dark and bright areas of the image visible.

1. Go to **Settings > Image**.
2. If required, turn on WDR under **Wide dynamic range**.



Image without WDR.



Image with WDR.

Note

WDR may cause artifacts in the image.

Find out more about WDR and how to use it at axis.com/web-articles/wdr

About view area

A view area is a cropped part of the full view. You can stream and store view areas instead of the full view to minimize bandwidth and storage needs. PTZ is enabled for all view areas. By using view areas you can create preset positions and also remove parts of the full view, for example, the sky.

AXIS M30 Network Camera Series

Setup

Privacy masks

Hide parts of the image with privacy masks

What is a privacy mask?

A privacy mask is a user-defined area that prevents users from viewing a part of the monitored area. In the video stream, privacy masks appear as blocks of solid color.

A privacy mask is a user-defined area that covers a part of the monitored area. In the video stream, privacy masks appear either as blocks of solid color or with a mosaic pattern.

You'll see the privacy mask on all snapshots, recorded video, and live streams.

You can use the VAPIX® application programming interface (API) to turn off the privacy masks.

Important

Using multiple privacy masks may affect the product's performance.

Note

Privacy masks may appear warped in some view modes.

Note

If you view the video stream over HDMI and restart the product, the privacy masks will disappear. To show the privacy masks again, restart the video stream.

Create a privacy mask

To create a privacy mask, go to **Settings > Privacy mask**.

Overlays

About overlays

Note

Image and text overlay will not be displayed on video stream over HDMI.

Overlays are superimposed over the video stream. They are used to provide extra information during recordings, such as a timestamp, or during product installation and configuration.

Make the camera show a text overlay when it detects motion

This example explains how to display the text "Motion detected" when the camera detects motion:

Make sure the AXIS Video Motion Detection application is running:

1. Go to **Settings > Apps > AXIS Video Motion Detection**.
2. Start the application if it is not already running.
3. Make sure you have set up the application according to your needs.

Add the overlay text:

4. Go to **Settings > Overlay**.
5. Select **Create overlay** and select **Text overlay**.
6. Enter #D in the text field.

AXIS M30 Network Camera Series

Setup

7. Choose text size and appearance.
8. To position the text overlay, choose **Custom** or one of the presets.

Create an action rule:

9. Go to **System > Events > Action rules**.
10. Create an action rule with **AXIS Video Motion Detection** as trigger.
11. From the list of actions, select **Overlay text**.
12. Type "Motion detected".
13. Set the duration.

Note

If you update the overlay text it will be automatically updated on all video streams dynamically.

PTZ (Pan Tilt Zoom)

How to limit zoom movements

In this example, the camera is surveilling a parking lot with nearby apartment buildings. Set zoom limits to ensure privacy for residents.

To limit zoom movements, go to **Settings > PTZ > Limits**.

About guard tours

A guard tour displays the video stream from different preset positions either in a predetermined or random order, and for configurable periods of time. Once started, a guard tour continues to run until stopped, even when there are no clients (web browsers) viewing the images.

Create a guard tour with preset positions

1. Go to **Settings > PTZ > Guard tours**
2. Click **+**.
3. Select **Preset position**.
4. To edit the guard tour's properties, click 
5. Type a name for the guard tour and specify the pause length in minutes between each tour.
6. If you want the guard tour to go to the preset positions in a random order, turn on **Shuffle**.
7. Click **Done**.
8. Click **Add** to add the preset positions that you want in your guard tour.
9. Click **Done** to exit the guard tour settings.
10. To schedule the guard tour, go to **System > Events**.

AXIS M30 Network Camera Series

Setup

Streaming and storage

Choose video compression format

Decide which compression method to use based on your viewing requirements, and on the properties of your network. The available options are:

Motion JPEG

Motion JPEG or MJPEG is a digital video sequence that is made up of a series of individual JPEG images. These images are then displayed and updated at a rate sufficient to create a stream that shows constantly updated motion. For the viewer to perceive motion video the rate must be at least 16 image frames per second. Full motion video is perceived at 30 (NTSC) or 25 (PAL) frames per second.

The Motion JPEG stream uses considerable amounts of bandwidth, but provides excellent image quality and access to every image contained in the stream.

H.264 or MPEG-4 Part 10/AVC

Note

H.264 is a licensed technology. The Axis product includes one H.264 viewing client license. Installing additional unlicensed copies of the client is prohibited. To purchase additional licenses, contact your Axis reseller.

H.264 can, without compromising image quality, reduce the size of a digital video file by more than 80% compared to the Motion JPEG format and by as much as 50% compared to the MPEG-4 standard. This means that less network bandwidth and storage space are required for a video file. Or seen another way, higher video quality can be achieved for a given bitrate.

Reduce bandwidth and storage

Important

If you reduce the bandwidth it can result in loss of details in the picture.

1. Go to live view and select **H.264**.
2. Go to **Settings > Stream**.
3. Do one or more of the following:
 - Turn on the Zipstream functionality and select the desired level.
 - Turn on dynamic GOP and set a high GOP length value.
 - Increase the compression.
 - Turn on dynamic FPS.

View a live video stream on a monitor

Your camera can transmit a live video stream to an HDMI monitor even without a network connection. The monitor can be used for surveillance purposes or for public viewing, e.g. in a store.

1. Connect an external monitor using the HDMI connector.
2. Change the HDMI settings under **Settings > System > HDMI**.

Important

In order to view the video stream via the HDMI connector, be sure to select a capture mode that supports HDMI.

Set up network storage

To store recordings on the network, you need to set up network storage:

AXIS M30 Network Camera Series

Setup

1. Go to **Settings > System > Storage**.
2. Click **Setup** under **Network storage**.
3. Enter the IP address of the host server.
4. Enter the name of the shared location on the host server.
5. Move the switch if the share requires a login, and enter username and password.
6. Click **Connect**.

Record and watch video

To record video you must first set up network storage, see *Set up network storage on page 13*, or have an SD card installed.

1. Go to the camera's live view.
2. Click on **Record** once to start recording and one more time to stop recording.

To watch your recording:

1. Click on **Storage > Go to recordings**.
2. Select your recording in the list and it will play automatically.

Events

Events

The event pages allow you to configure your product to perform actions when different events occur. For example, the product can start a recording or send an email notification when motion is detected. The set of conditions that defines how and when the action is triggered is called an action rule.

Trigger an action

1. Go to **Settings > System > Events** to set up an action rule. The action rule defines when the camera will perform certain actions. Action rules can be setup as scheduled, recurring, or for example, triggered by motion detection.
2. Select what **Trigger** must be met to trigger the action. If you specify more than one trigger for the action rule, all of them must be met to trigger the action.
3. Select which **Action** the camera should perform when the conditions are met.

Note

If you make changes to an active action rule, the action rule needs to be restarted for the changes to take effect.

Record video when the camera detects motion

This example explains how to set up the camera to start recording to the SD card five seconds before it detects motion and to stop one minute after.

Make sure the AXIS Video Motion Detection application is running:

1. Go to **Settings > Apps > AXIS Video Motion Detection**.
2. Start the application if it is not already running.
3. Make sure you have set up the application according to your needs.

Create an action rule:

AXIS M30 Network Camera Series

Setup

4. Go to **Settings > System > Events** and add an action rule.
5. Type a name for the action rule.
6. From the list of triggers, select **Applications** and then select **AXIS Video Motion Detection (VMD)**.
7. From the list of actions, select **Record video**.
8. Select an existing stream profile or create a new one.
9. Enable and set the pre-trigger time to 5 seconds.
10. Enable **While the rule is active**.
11. Enable and set the post-trigger time to 60 seconds.
12. Select **SD card** from the list of storage options.
13. Click **Ok**.

Record video when a PIR detector senses motion

This example explains how to connect an Axis PIR detector to the camera, and set up the camera to start recording when the detector senses motion.

Required hardware

- 3-wire cable (ground, power, I/O)
- Axis PIR detector

NOTICE

Disconnect the camera from power before connecting the wires. Reconnect to power after all connections are done.

Connect the wires to the camera's I/O connector

Note

For information on the I/O connector, see *Connectors* on page 22

1. Connect the ground wire to pin 1 (GND/-).
2. Connect the power wire to pin 2 (12V DC output).
3. Connect the I/O wire to pin 3 (I/O input).

Connect the wires to the PIR detector's I/O connector

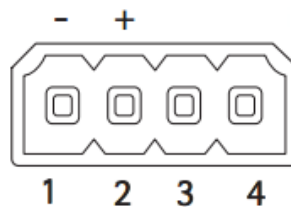

1. Connect the other end of the ground wire to pin 1 (GND/-).
2. Connect the other end of the power wire to pin 2 (DC input/+).
3. Connect the other end of the I/O wire to pin 3 (I/O output).

AXIS M30 Network Camera Series

Setup

Configure the I/O port in the camera's webpage

1. Go to **Settings > System > I/O ports**.
2. Give the input module a descriptive name.
3. To make the PIR detector send a signal to the camera when it senses motion, select **Closed circuit** in the drop-down list.

To trigger the camera to start recording when it receives a signal from the PIR detector, you need to create an action rule in the camera's webpage.

Detect tampering with input signal

This example explains how to trigger an alarm when the input signal has been cut or short-circuited. For more information about the I/O connector, see [page 23](#).

1. Go to **Settings > System > I/O Ports** and enable **Supervised I/O**.

Create an action rule:

2. Go to **Settings > System > Events** and create an action rule.
3. Type a name for the action rule.
4. From the list of triggers, select **Input Signal** and then **Digital input port**. Select **Input 1** and set **Tampered** to **Yes**.
5. From the list of schedules, select **Always**.
6. From the list of actions, select **Send Notification** and then select a recipient or create a new recipient.
7. Click **OK**.

Send an email automatically if someone spray paints the lens

1. Go to **System > Detectors**.
2. Turn on **Trigger on dark images**. This will trigger an alarm if the lens is sprayed, covered, or rendered severely out of focus.
3. Set a duration for **Trigger after**. The value indicates the time that must pass before an email is sent.

Create an action rule:

4. Go to **Events > Action rules** and add an action rule.
5. Enter a name for the action rule.
6. From the list of triggers, select **Detectors** and then select **Tampering**.
7. From the list of actions, select **Send Notification** and then select a recipient from the list or click **New Recipient** to create a new recipient.
8. Enter name and address for the email.
9. Click **Ok**.

Applications

Applications

AXIS Camera Application Platform (ACAP) is an open platform that enables third parties to develop analytics and other applications for Axis products. To find out more about available applications, downloads, trials and licenses, go to axis.com/applications

To find the user manuals for Axis applications, go to axis.com

AXIS M30 Network Camera Series

Setup

Note

- Several applications can run at the same time but some applications might not be compatible with each other. Certain combinations of applications might require too much processing power or memory resources when run in parallel. Verify that the applications work together before deployment.

AXIS M30 Network Camera Series

Troubleshooting

Troubleshooting

If you can't find what you're looking for here, try the troubleshooting section at axis.com/support

Reset to factory default settings

Important

Reset to factory default should be used with caution. A reset to factory default resets all settings, including the IP address, to the factory default values.

To reset the product to the factory default settings:

1. Disconnect power from the product.
2. Press and hold the control button while reconnecting power. See *Product overview on page 4*.
3. Keep the control button pressed for 15–30 seconds until the status LED indicator flashes amber.
4. Release the control button. The process is complete when the status LED indicator turns green. The product has been reset to the factory default settings. If no DHCP server is available on the network, the default IP address is 192.168.0.90
5. Use the installation and management software tools to assign an IP address, set the password, and access the video stream.

The installation and management software tools are available from the support pages on axis.com/support

1. Press and hold the control button and the power button for 15–30 seconds until the status LED indicator flashes amber. See *Product overview on page 4*.
2. Release the control button but continue to hold down the power button until the status LED indicator turns green.
3. Release the power button and assemble the product.
4. The process is now complete. The product has been reset to the factory default settings. If no DHCP server is available on the network, the default IP address is 192.168.0.90
5. Using the installation and management software tools to assign an IP address, set the password and access the video stream.

It is also possible to reset parameters to factory default through the web interface. Go to **Settings > System > Maintenance** and click **Default**.

Check the current firmware

Firmware is the software that determines the functionality of network devices. One of your first actions when troubleshooting a problem should be to check the current firmware version. The latest version may contain a correction that fixes your particular problem.

To check the current firmware:

1. Go to the product's webpage.
2. Click on the help menu. 
3. Click **About**.

AXIS M30 Network Camera Series

Troubleshooting

Upgrade the firmware

Important

Preconfigured and customized settings are saved when the firmware is upgraded (provided that the features are available in the new firmware) although this is not guaranteed by Axis Communications AB.

Important

Make sure the cover is attached during upgrade to avoid installation failure.

Important

Make sure the product remains connected to the power source throughout the upgrade process.

Note

When you upgrade the product with the latest firmware in the active track, the product receives the latest functionality available. Always read the upgrade instructions and release notes available with each new release before upgrading the firmware. To find the latest firmware and the release notes, go to axis.com/support/firmware

1. Download the firmware file to your computer, available free of charge at axis.com/support/firmware
2. Log in to the product as an administrator.
3. Go to **Settings > System > Maintenance**. Follow the instructions on the page. When the upgrade has finished, the product restarts automatically.

AXIS Device Manager can be used for multiple upgrades. Find out more at axis.com/products/axis-device-manager

Technical issues, clues and solutions

If you can't find what you're looking for here, try the troubleshooting section at axis.com/support

Problems upgrading the firmware

Firmware upgrade failure	If the firmware upgrade fails, the device reloads the previous firmware. The most common reason is that the wrong firmware file has been uploaded. Check that the name of the firmware file corresponds to your device and try again.
--------------------------	---

Problems setting the IP address

The device is located on a different subnet	If the IP address intended for the device and the IP address of the computer used to access the device are located on different subnets, you cannot set the IP address. Contact your network administrator to obtain an IP address.
---	---

The IP address is being used by another device	Disconnect the Axis device from the network. Run the ping command (in a Command/DOS window, type <code>ping</code> and the IP address of the device): <ul style="list-style-type: none">• If you receive: <code>Reply from <IP address>: bytes=32; time=10...</code> this means that the IP address may already be in use by another device on the network. Obtain a new IP address from the network administrator and reinstall the device.• If you receive: <code>Request timed out</code>, this means that the IP address is available for use with the Axis device. Check all cabling and reinstall the device.
--	--

Possible IP address conflict with another device on the same subnet	The static IP address in the Axis device is used before the DHCP server sets a dynamic address. This means that if the same default static IP address is also used by another device, there may be problems accessing the device.
---	---

AXIS M30 Network Camera Series

Troubleshooting

The device cannot be accessed from a browser

Cannot log in	<p>When HTTPS is enabled, ensure that the correct protocol (HTTP or HTTPS) is used when attempting to log in. You may need to manually type <code>http</code> or <code>https</code> in the browser's address field.</p> <p>If the password for the user <code>root</code> is lost, the device must be reset to the factory default settings. See <i>Reset to factory default settings on page 18</i>.</p>
The IP address has been changed by DHCP	<p>IP addresses obtained from a DHCP server are dynamic and may change. If the IP address has been changed, use AXIS IP Utility or AXIS Device Manager to locate the device on the network. Identify the device using its model or serial number, or by the DNS name (if the name has been configured).</p> <p>If required, a static IP address can be assigned manually. For instructions, go to axis.com/support</p>
Certificate error when using IEEE 802.1X	<p>For authentication to work properly, the date and time settings in the Axis device must be synchronized with an NTP server. Go to Settings > System > Date and time</p>

The device is accessible locally but not externally

To access the device externally, we recommend using the video management software AXIS Companion for Windows®. For instructions and download, go to axis.com/products/axis-companion

Problems with streaming

Multicast H.264 only accessible by local clients	<p>Check if your router supports multicasting, or if the router settings between the client and the device need to be configured. The TTL (Time To Live) value may need to be increased.</p>
No multicast H.264 displayed in the client	<p>Check with your network administrator that the multicast addresses used by the Axis device are valid for your network.</p> <p>Check with your network administrator to see if there is a firewall preventing viewing.</p>
Poor rendering of H.264 images	<p>Ensure that your graphics card is using the latest driver. The latest drivers can usually be downloaded from the manufacturer's website.</p>
Color saturation is different in H.264 and Motion JPEG	<p>Modify the settings for your graphics adapter. Go to the adapter's documentation for more information.</p>
Lower frame rate than expected	<ul style="list-style-type: none">• See <i>Performance considerations on page 20</i>.• Reduce the number of applications running on the client computer.• Limit the number of simultaneous viewers.• Check with the network administrator that there is enough bandwidth available.• Lower the image resolution.• The maximum frames per second is dependent on the utility frequency (60/50 Hz) of the Axis device.

Performance considerations

When setting up your system, it is important to consider how various settings and situations affect the performance. Some factors affect the amount of bandwidth (the bitrate) required, others can affect the frame rate, and some affect both. If the load on the CPU reaches its maximum, this also affects the frame rate.

The following factors are the most important to consider:

- High image resolution or lower compression levels result in images containing more data which in turn affects the bandwidth.
- Rotating the lens manually will result in better performance compared to rotating the image from the GUI.
- Removing or attaching the cover will restart the camera.
- Access by large numbers of Motion JPEG or unicast H.264 clients affects the bandwidth.

AXIS M30 Network Camera Series

Troubleshooting

- Simultaneous viewing of different streams (resolution, compression) by different clients affects both frame rate and bandwidth.

Use identical streams wherever possible to maintain a high frame rate. Stream profiles can be used to ensure that streams are identical.

- Accessing Motion JPEG and H.264 video streams simultaneously affects both frame rate and bandwidth.
- Heavy usage of event settings affects the product's CPU load which in turn affects the frame rate.
- Using HTTPS may reduce frame rate, in particular if streaming Motion JPEG.
- Heavy network utilization due to poor infrastructure affects the bandwidth.
- Viewing on poorly performing client computers lowers perceived performance and affects frame rate.
- Running multiple AXIS Camera Application Platform (ACAP) applications simultaneously may affect the frame rate and the general performance.

AXIS M30 Network Camera Series

Specifications

Specifications

To find the latest version of the product's datasheet, go to the product page at axis.com and locate **Support & Documentation**.

LED indicators

Note

The Status LED can be configured to flash while an event is active.

Status LED	Indication
Unlit	Connection and normal operation.
Green	Shows steady green for 10 seconds for normal operation after startup completed.
Amber	Steady during startup. Flashes during firmware upgrade or reset to factory default.
Amber/Red	Flashes amber/red if network connection is unavailable or lost.
Red	Firmware upgrade failure.

SD card slot

NOTICE

- Risk of damage to SD card. Do not use sharp tools, metal objects, or excessive force when inserting or removing the SD card. Use your fingers to insert and remove the card.
- Risk of data loss and corrupted recordings. Do not remove the SD card while the product is running. Unmount the SD card from the product's webpage before removal.

This product supports microSD/microSDHC/microSDXC cards.

For SD card recommendations, see axis.com



microSD, microSDHC, and microSDXC Logos are trademarks of SD-3C LLC. microSD, microSDHC, microSDXC are trademarks or registered trademarks of SD-3C, LLC in the United States, other countries or both.

Buttons

Control button

The control button is used for:

- Resetting the product to factory default settings. See *Reset to factory default settings on page 18*.
- Connecting to an AXIS Video Hosting System service. To connect, press and hold the button for about 3 seconds until the status LED flashes green.

Connectors

HDMI connector

Use the HDMI™ connector to connect a display or public view monitor.

AXIS M30 Network Camera Series

Specifications

Network connector

RJ45 Ethernet connector with Power over Ethernet (PoE).

I/O connector

Use the I/O connector with external devices in combination with, for example, motion detection, event triggering, and alarm notifications. In addition to the 0 V DC reference point and power (DC output), the I/O connector provides the interface to:

Digital input – For connecting devices that can toggle between an open and closed circuit, for example PIR sensors, door/window contacts, and glass break detectors.

Supervised input – Enables possibility to detect tampering on a digital input.

Digital output – For connecting external devices such as relays and LEDs. Connected devices can be activated by the VAPIX® Application Programming Interface or from the product's webpage.

4-pin terminal block

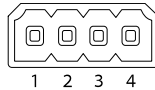

Function	Pin	Notes	Specifications
DC ground	1		0 V DC
DC output	2	Can be used to power auxiliary equipment. Note: This pin can only be used as power out.	12 V DC Max load = 25 mA
Digital Input or Supervised Input	3	Connect to pin 1 to activate, or leave floating (unconnected) to deactivate. To use supervised input, install end-of-line resistors. See connection diagram for information about how to connect the resistors.	0 to max 30 V DC
Digital Output	4	Internally connected to pin 1 (DC ground) when active, and floating (unconnected) when inactive. If used with an inductive load, e.g., a relay, connect a diode in parallel with the load, to protect against voltage transients.	0 to max 30 V DC, open drain, 100 mA

Example

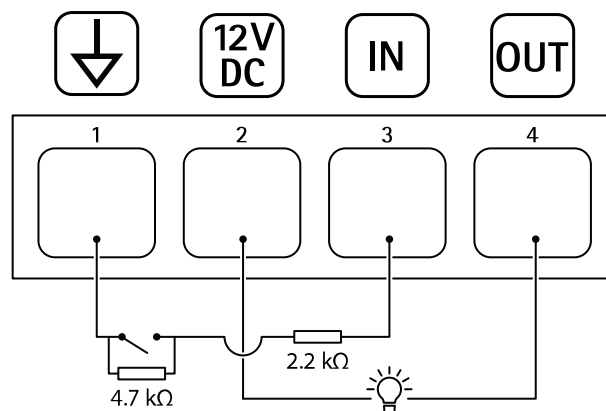

- 1 DC ground
- 2 DC output 12 V, max 25 mA
- 3 Supervised input

AXIS M30 Network Camera Series

Specifications

4 *Digital output*

