

## **AXIS M11 Network Camera Series**

**AXIS M1124 Network Camera**

**AXIS M1125 Network Camera**

**User Manual**

# AXIS M11 Network Camera Series

## Table of Contents

---

|   |    |
|---|----|
| <b>About this manual</b> .....                          | 3  |
| <b>Product overview</b> .....                           | 4  |
| <b>Find the device on the network</b> .....             | 5  |
| Browser support .....                                   | 5  |
| <b>Access the device</b> .....                          | 6  |
| Verify that no one has tampered with the firmware ..... | 6  |
| Set a secure password for the root account .....        | 6  |
| Secure passwords .....                                  | 6  |
| <b>Setup</b> .....                                      | 7  |
| Webpage overview .....                                  | 7  |
| Image quality .....                                     | 9  |
| Privacy masks .....                                     | 12 |
| Overlays .....  | 12 |
| Pan, tilt, and zoom (PTZ) .....                         | 13 |
| Streaming and storage .....                             | 14 |
| Events .....  | 15 |
| Applications .....                                      | 18 |
| <b>Troubleshooting</b> .....                            | 19 |
| Reset to factory default settings .....                 | 19 |
| Firmware options .....                                  | 19 |
| Check the current firmware .....                        | 19 |
| Upgrade the firmware .....                              | 20 |
| Technical issues, clues and solutions .....             | 20 |
| Performance considerations .....                        | 21 |
| <b>Specifications</b> .....                             | 23 |
| LED indicators .....                                    | 23 |
| SD card slot .....                                      | 23 |
| Buttons .....   | 23 |
| Connectors .....  | 24 |

# AXIS M11 Network Camera Series

## About this manual

---

### About this manual

This user manual describes multiple products. Some of the instructions may not be relevant for your product.

# AXIS M11 Network Camera Series

## Product overview

---

### Product overview

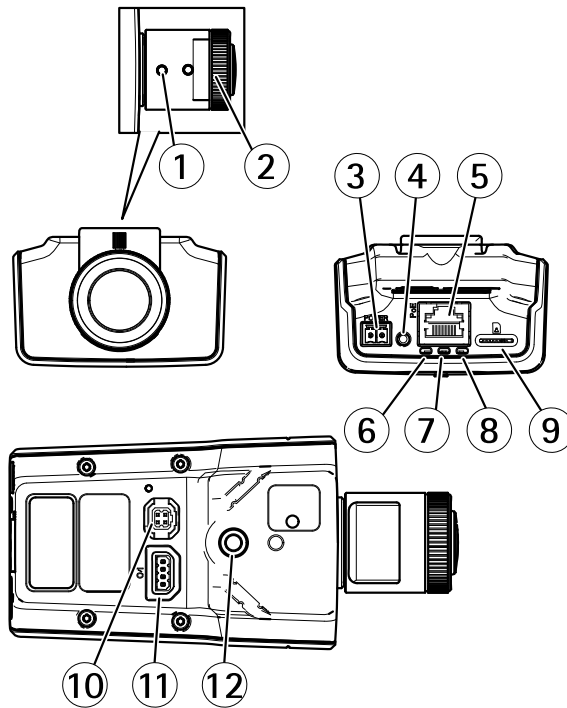

- 1 Zoom puller
- 2 Focus ring
- 3 Power connector
- 4 Control button
- 5 Network connector
- 6 Power LED
- 7 Status LED
- 8 Network LED
- 9 microSD card slot
- 10 Iris connector
- 11 I/O connector
- 12 1/4" Screw mount

# AXIS M11 Network Camera Series

## Find the device on the network

---

### Find the device on the network

To find Axis devices on the network and assign them IP addresses in Windows®, use AXIS IP Utility or AXIS Device Manager. Both applications are free and can be downloaded from [axis.com/support](http://axis.com/support).

For more information about how to find and assign IP addresses, see the document *How to assign an IP address and access your device* on the device page at [axis.com](http://axis.com).

### Browser support

You can use the device with the following browsers:

|                         | Chrome™     | Firefox® | Edge® | Safari® |
|-------------------------|-------------|----------|-------|---------|
| Windows®                | recommended | x        | x     |         |
| OS X®                   | recommended |          |       | x       |
| Other operating systems | x           | x        |       |         |

If you need more information about recommended browsers, go to [axis.com/browser-support](http://axis.com/browser-support).

# AXIS M11 Network Camera Series

## Access the device

---

### Access the device

1. Open a browser and enter the IP address or host name of the Axis device.

If you have a Mac computer (OS X), go to Safari, click on Bonjour and select the device from the drop-down list. To add Bonjour as a browser bookmark, go to **Safari > Preferences**.

If you do not know the IP address, use AXIS IP Utility or AXIS Device Manager to find the device on the network.

2. Enter the username and password. If you access the device for the first time, you must set the root password. See *Set a secure password for the root account on page 6*.
3. The live view page opens in your browser.

### Verify that no one has tampered with the firmware

To make sure that the device has its original Axis firmware, or to take full control of the device after a security attack:

1. Reset to factory default settings. See *Reset to factory default settings on page 19*.  
After the reset, secure boot guarantees the state of the device.
2. Configure and install the device.

### Set a secure password for the root account

#### Important

The default administrator username is **root**. If the password for root is lost, reset the device to factory default settings.

1. Type a password. Follow the instructions about secure passwords. See *Secure passwords on page 6*.
2. Retype the password to confirm the spelling.
3. Click **Create login**. The password has now been configured.

### Secure passwords

#### Important

Axis devices send the initially set password in clear text over the network. To protect your device after the first login, set up a secure and encrypted HTTPS connection and then change the password.

The device password is the primary protection for your data and services. Axis devices do not impose a password policy as they may be used in various types of installations.

To protect your data we strongly recommend that you:

- Use a password with at least 8 characters, preferably created by a password generator.
- Don't expose the password.
- Change the password at a recurring interval, at least once a year.

# AXIS M11 Network Camera Series

## Setup

---

### Setup

#### Webpage overview



- 1 Live view control bar
- 2 Live view
- 3 Product name
- 4 User information, color themes, and help
- 5 Video control bar
- 6 Settings toggle

# AXIS M11 Network Camera Series

## Setup

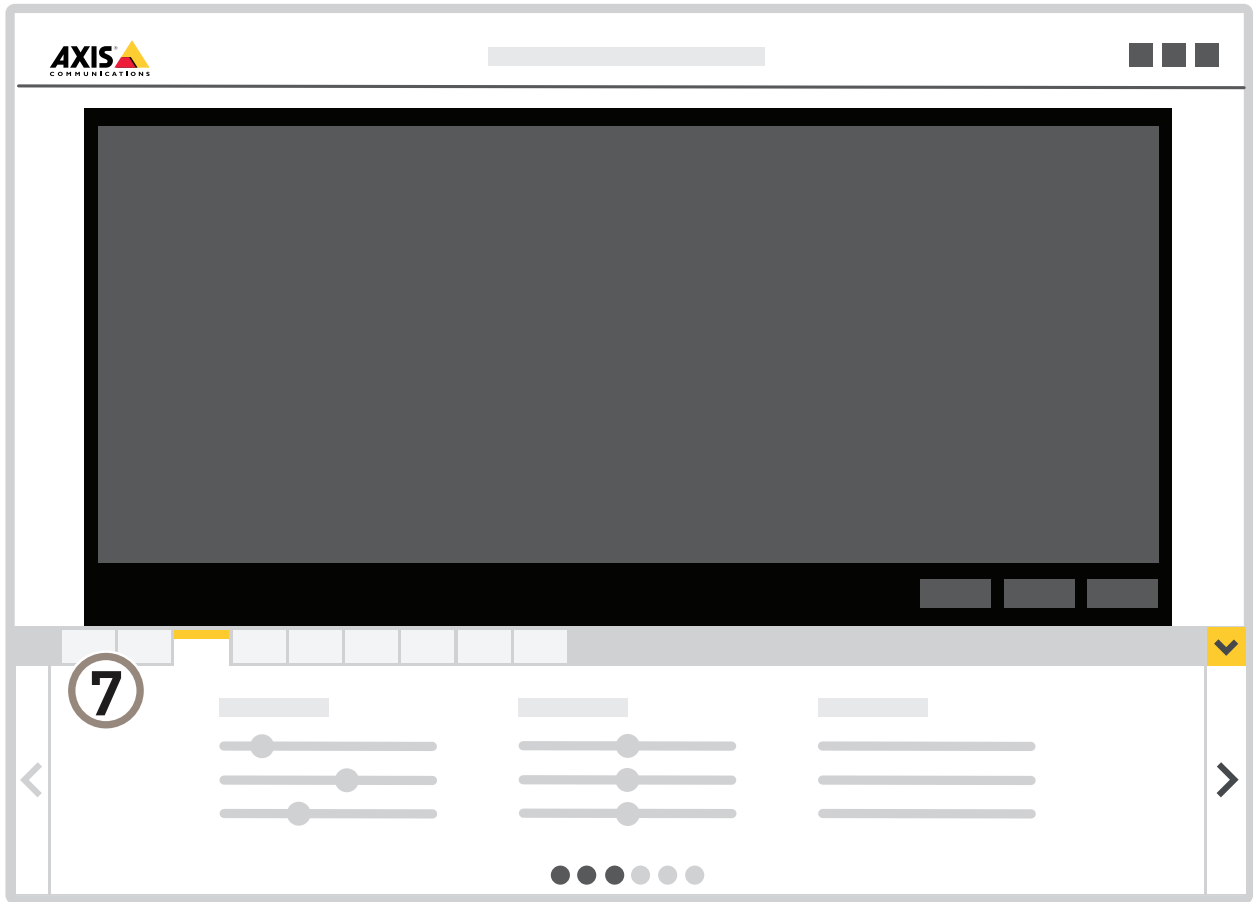

7 Settings tabs

### Need more help?

You can access the built-in help from the device's webpage. The help provides more detailed information on the device's features and their settings.

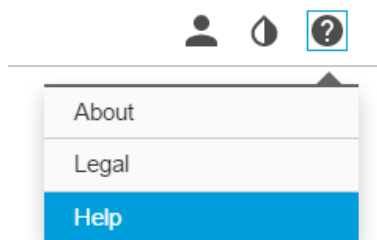



# AXIS M11 Network Camera Series

## Setup

---

### Image quality

#### Level the camera

To adjust the view in relation to a reference area or object, use the leveling guide in combination with a mechanical adjustment of the camera.

1. Go to **Settings > System > Orientation** and click  .
2. Adjust the camera mechanically until the position of the reference area or object, is aligned with the leveling guide.

#### Select exposure mode

There are different exposure mode options in the camera that adjusts aperture, shutter speed, and gain to improve image quality for specific surveillance scenes. Go to **Settings > Image > Exposure** and select between the following exposure modes:

#### Benefit from IR light in low-light conditions using night mode

Your camera uses visible light to deliver color images during the day. As the available light diminishes, you can set the camera to automatically shift to night mode, in which the camera uses both visible light and near-infrared light to deliver black-and-white images. Since the camera uses more of the available light it can deliver brighter, more detailed, images.

1. Go to **Settings > Image > Day and night**, and make sure that the **IR cut filter** is set to **Auto**.

#### Reduce noise in low-light conditions

To reduce noise in low-light conditions, you can adjust one or more of the following settings:

##### Note

A high max shutter value can result in motion blur.

- To slow down the shutter speed, set max shutter to the highest possible value.
- Reduce sharpness in the image.

#### Reduce motion blur in low-light conditions

To reduce motion blur in low-light conditions, you can adjust one or more of the following settings:

##### Note

Image noise will increase if you increase the gain.

- Increase shutter speed and gain. Go to **Settings > Image > Exposure** and set **Max shutter** to a shorter time, and **Max gain** to a higher value.

If you are still experiencing motion blur, you can try one of the following:

- Increase the light level in the scene.
- Mount the camera so that objects move toward it or away from it rather than sideways.

#### Handle scenes with strong backlight

Dynamic range is the difference in light levels in an image. In some cases the difference between the darkest and the brightest areas can be significant. The result is often an image where either the dark or the bright areas are visible. Wide dynamic range (WDR) makes both dark and bright areas of the image visible.

1. Go to **Settings > Image > Wide dynamic range**.

# AXIS M11 Network Camera Series

## Setup

---

2. If required, turn on WDR.
3. Use the Local contrast slider to adjust the amount of WDR.



*Image without WDR.*



*Image with WDR.*

### Note

WDR may cause artifacts in the image.

Find out more about WDR and how to use it at [axis.com/web-articles/wdr](https://axis.com/web-articles/wdr).

### Monitor long and narrow areas

Use corridor format to better utilize the full field of view in a long and narrow area, for example a staircase, hallway, road, or tunnel.

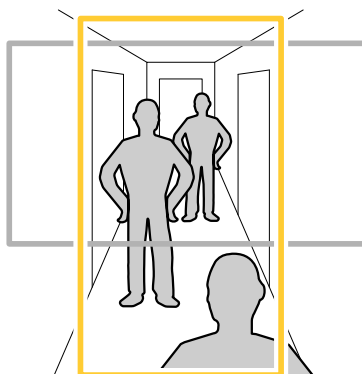

1. Depending on your device, turn the camera or the 3-axis lens in the camera 90° or 270°.
2. If the device doesn't rotate the view automatically, log in to the webpage and go to **Settings > System > Orientation**.

# AXIS M11 Network Camera Series

## Setup

3. Click .
4. Rotate the view 90° or 270°.

Find out more at [axis.com/axis-corridor-format](https://axis.com/axis-corridor-format).

### Improve facial recognition

To better recognize the face of a person passing by the camera, you can set the optimal pixel resolution with the camera's pixel counter.

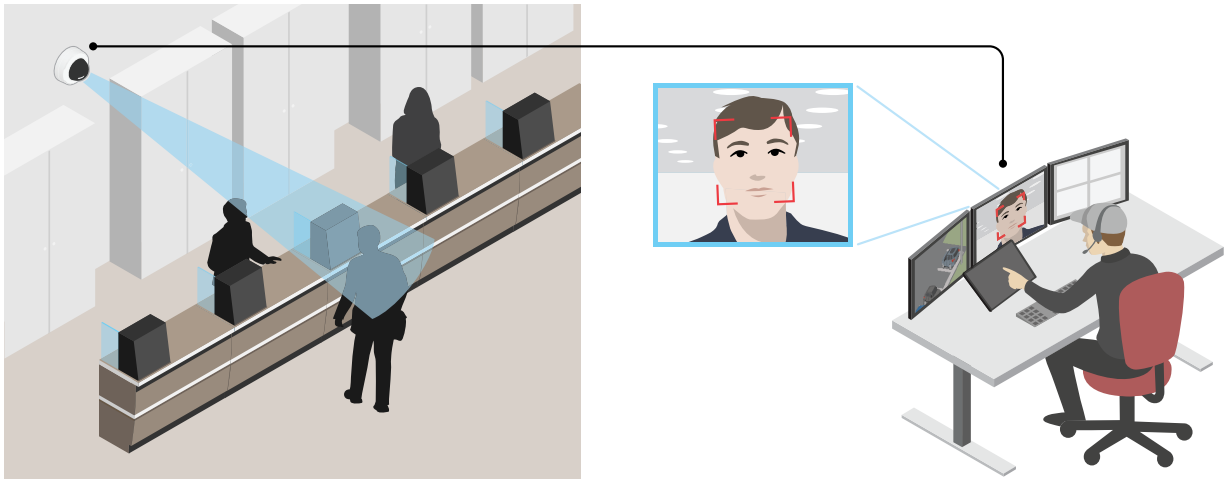

1. Go to **Settings > System > Orientation** and click .
2. In the camera's live view, adjust the size and placement of the rectangle around the area of interest, for example, where the faces of passing persons are expected to appear. You can then see the number of pixels represented by the sides of the rectangle.

#### Note

You can use an object of a known size in the view as a reference to decide how much resolution is needed for recognition.

### Improve license plate recognition

To better recognize the license plate of a car passing by the camera, you can apply and adjust a number of things.

One option is to use the pixel counter in your camera to set the optimal pixel resolution:

1. Go to **Settings > System > Orientation** and click .
2. Adjust the size and placement of the rectangle in the camera's live view around the area of interest, for example where the license plates of passing cars are expected to appear. You can then see the number of pixels represented by the sides of the rectangle.

#### Note

You can use an object of a known size in the view as a reference to decide how much resolution is needed for recognition.

In addition, you can try to adjust the following to optimize license plate recognition:

- Shutter speed
- Gain

# AXIS M11 Network Camera Series

## Setup

---

- Zoom

### View area

A view area is a cropped part of the full view. You can stream and store view areas instead of the full view to minimize bandwidth and storage needs. If you enable PTZ for a view area, you can pan, tilt and zoom within it. By using view areas you can remove parts of the full view, for example, the sky.

When you set up a view area, we recommend you to set the video stream resolution to the same size as or smaller than the view area size. If you set the video stream resolution larger than the view area size it implies digitally scaled up video after sensor capture, which requires more bandwidth without adding image information.

### Privacy masks

A privacy mask is a user-defined area that prevents users from viewing a part of the monitored area. In the video stream, privacy masks appear as blocks of solid color or blurred image elements.

You'll see the privacy mask on all snapshots, recorded video, and live streams.

You can use the VAPIX® application programming interface (API) to turn off the privacy masks.

#### Important

If you use multiple privacy masks it may affect the product's performance.

### Hide parts of the image with privacy masks

Create a privacy mask to hide a part of the image:

1. Go to **Settings > Privacy mask**.
2. Click **New**.

### Overlays

Overlays are superimposed over the video stream. They are used to provide extra information during recordings, such as a timestamp, or during product installation and configuration. You can add either text or an image.

### Show a text overlay in the video stream when the device detects motion

This example explains how to display the text "Motion detected" when the device detects motion:

Make sure the AXIS Video Motion Detection application is running:

1. Go to **Settings > Apps > AXIS Video Motion Detection**.
2. Start the application if it is not already running.
3. Make sure you have set up the application according to your needs.

Add the overlay text:

4. Go to **Settings > Overlay**.
5. Enter #D in the text field.
6. Choose text size and appearance.

Create a rule:

7. Go to **System > Events > Rules** and add a rule.

# AXIS M11 Network Camera Series

## Setup

---

8. Type a name for the rule.
9. In the list of conditions, select **AXIS Video Motion Detection**.
10. In the list of actions, select **Use overlay text**.
11. Select a view area.
12. Type "Motion detected".
13. Set the duration.
14. Click **Save**.

## Pan, tilt, and zoom (PTZ)

### Limit the pan, tilt, and zoom movements

If there are parts of the scene that you don't want the camera to reach, you can limit the pan, tilt, and zoom movements. For example, you want to protect the privacy of residents in an apartment building, which is located close to a parking lot that you intend to monitor. To limit the movements, go to **Settings > PTZ > Limits**.

### See above the horizon

In some cases, you might want to look above the default upper tilt limit to see above the horizon.

1. Go to **Settings > PTZ > Limits**
2. Set the upper limit to the maximum value and click **Save**.

### Guard tours

A guard tour displays the video stream from different preset positions either in a predetermined or random order, and for configurable periods of time. Once started, a guard tour continues to run until stopped, even when there are no clients (web browsers) viewing the images.

### Create a guard tour with preset positions

A guard tour displays the video stream from different preset positions either in a predetermined or random order, and for configurable periods of time.

1. Go to **Settings > PTZ > Guard tours**.
2. Click **+**.
3. Select **Preset position**.
4. To edit the guard tour's properties, click .
5. Type a name for the guard tour and specify the pause length in minutes between each tour.
6. If you want the guard tour to go to the preset positions in a random order, turn on **Shuffle**.
7. Click **Done**.
8. Click **Add** to add the preset positions that you want in your guard tour.
9. Click **Done** to exit the guard tour settings.
10. To schedule the guard tour, go to **System > Events**.

# AXIS M11 Network Camera Series

## Setup

---

### Streaming and storage

#### Video compression formats

Decide which compression method to use based on your viewing requirements, and on the properties of your network. The available options are:

##### Motion JPEG

Motion JPEG, or MJPEG, is a digital video sequence that is made up of a series of individual JPEG images. These images are then displayed and updated at a rate sufficient to create a stream that shows constantly updated motion. For the viewer to perceive motion video the rate must be at least 16 image frames per second. Full motion video is perceived at 30 (NTSC) or 25 (PAL) frames per second.

The Motion JPEG stream uses considerable amounts of bandwidth, but provides excellent image quality and access to every image contained in the stream.

##### H.264 or MPEG-4 Part 10/AVC

###### Note

H.264 is a licensed technology. The Axis product includes one H.264 viewing client license. To install additional unlicensed copies of the client is prohibited. To purchase additional licenses, contact your Axis reseller.

H.264 can, without compromising image quality, reduce the size of a digital video file by more than 80% compared to the Motion JPEG format and by as much as 50% compared to the MPEG-4 standard. This means that less network bandwidth and storage space are required for a video file. Or seen another way, higher video quality can be achieved for a given bitrate.

### Reduce bandwidth and storage

#### Important

If you reduce the bandwidth it can result in loss of details in the picture.

1. Go to live view and select **H.264**.
2. Go to **Settings > Stream**.
3. Do one or more of the following:
  - Turn on the Zipstream functionality and select the desired level.
  - Turn on dynamic GOP and set a high GOP length value.
  - Increase the compression.
  - Turn on dynamic FPS.

### Bitrate control

By setting the bitrate control you can manage the bandwidth consumption for your video stream.

#### Variable bitrate (VBR)

With variable bitrate the bandwidth varies based on the level of activity in the scene. The more activity in the scene, the more bandwidth is required. This option guarantees that image quality is constant but requires storage margins.

#### Maximum bitrate (MBR)

The maximum bitrate option allows you to set a target bitrate value to be able to handle system bitrate limitations. To keep the instantaneous bitrate below the specified target bitrate, there may be a decrease in image quality or the frame rate may decrease. You have the option to prioritize either image quality or frame rate. It is recommended to configure the target bitrate higher than the expected bitrate to have margins for additional complexity that needs to be captured.

#### Average bitrate (ABR)

With average bitrate, the bitrate is automatically adjusted over a longer timescale to meet the specified target and provide the

# AXIS M11 Network Camera Series

## Setup

---

best quality on the video stream based on available storage. Image quality is decreased uniformly. You can still get good image quality when there is activity in the scene. The average bitrate option allows you to define the total storage required to store the video stream for a specified amount of time (retention time) when image quality is adjusted to meet the specified target bitrate. Specify the average bitrate settings in one of the following ways:

- Set the target bitrate and the retention time to calculate the estimated storage need.
- Use the target bitrate calculator to calculate the average bitrate, based on available storage and desired retention time.

You have also the option to turn on maximum bitrate to specify a bitrate limit.

### Set up network storage

To store recordings on the network, you need to set up network storage:

1. Go to **Settings > System > Storage**.
2. Click **Setup** under **Network storage**.
3. Enter the IP address of the host server.
4. Enter the name of the shared location on the host server.
5. Move the switch if the share requires a login, and enter username and password.
6. Click **Connect**.

### How do Image, Stream, and Stream profile settings relate to each other?

The **Image** tab contains camera settings that affect all video streams from the product. If you change something in this tab, it immediately affects all video streams and recordings.

The **Stream** tab contains settings for video streams. You get these settings if you request a video stream from the product and don't specify for example resolution, or frame rate. When you change the settings in the **Stream** tab, it doesn't affect ongoing streams, but it will take effect when you start a new stream.

The **Stream profiles** settings override the settings from the **Stream** tab. If you request a stream with a specific stream profile, the stream contains the settings of that profile. If you request a stream without specifying a stream profile, or request a stream profile that doesn't exist in the product, the stream contains the settings from the **Stream** tab.

### Record and watch video

To record video you must first set up network storage, see *Set up network storage on page 15*, or have an SD card installed.

1. Go to the camera's live view.
2. Click on **Record** once to start recording and one more time to stop recording.

To watch your recording:

1. Click on **Storage > Go to recordings**.
2. Select your recording in the list and it will play automatically.

## Events

### Set up rules and alerts

You can create rules to make your device perform an action when certain events occur. A rule consists of conditions and actions. The conditions can be used to trigger the actions. For example, the device can start a recording or send an email when it detects motion, or show an overlay text when it records.

# AXIS M11 Network Camera Series

## Setup

---

### Trigger an action

1. Go to **Settings > System > Events** to set up a rule. The rule defines when the camera will perform certain actions. Rules can be setup as scheduled, recurring, or for example, triggered by motion detection.
2. Select the **Condition** that must be met to trigger the action. If you specify more than one condition for the rule, all of the conditions must be met to trigger the action.
3. Select which **Action** the camera should perform when the conditions are met.

#### Note

If you make changes to an active rule, then the rule needs to be restarted for the changes to take effect.

### Record video when the camera detects motion

This example explains how to set up the camera to start recording to the SD card five seconds before it detects motion and to stop one minute after.

Make sure the AXIS Video Motion Detection application is running:

1. Go to **Settings > Apps > AXIS Video Motion Detection**.
2. Start the application if it is not already running.
3. Make sure you have set up the application according to your needs.

Create a rule:

1. Go to **Settings > System > Events** and add a rule.
2. Type a name for the rule.
3. In the list of conditions, under **Application**, select **AXIS Video Motion Detection (VMD)**.
4. In the list of actions, under **Recordings**, select **Record video while the rule is active**.
5. Select an existing stream profile or create a new one.
6. Set the prebuffer time to 5 seconds.
7. Set the postbuffer time to 60 seconds.
8. In the list of storage options, select **SD card**.
9. Click **Save**.

### Record video when a PIR detector senses motion

This example explains how to connect an Axis PIR detector to the camera, and set up the camera to start recording when the detector senses motion.

#### Required hardware

- 3-wire cable (ground, power, I/O)
- Axis PIR detector

#### NOTICE

Disconnect the camera from power before connecting the wires. Reconnect to power after all connections are done.

Connect the wires to the camera's I/O connector



# AXIS M11 Network Camera Series

## Setup

---

### Note

For information on the I/O connector, see *Connectors* on page 24.

1. Connect the ground wire to pin 1 (GND/-).
2. Connect the power wire to pin 2 (12V DC output).
3. Connect the I/O wire to pin 3 (I/O input).

Connect the wires to the PIR detector's I/O connector

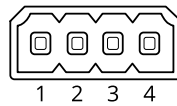

1. Connect the other end of the ground wire to pin 1 (GND/-).
2. Connect the other end of the power wire to pin 2 (DC input/+).
3. Connect the other end of the I/O wire to pin 3 (I/O output).

Configure the I/O port in the camera's webpage

1. Go to **Settings > System > I/O ports**.
2. Give the input module a descriptive name.
3. To make the PIR detector send a signal to the camera when it senses motion, select **Closed circuit** in the drop-down list.

To trigger the camera to start recording when it receives a signal from the PIR detector, you need to create a rule in the camera's webpage.

### Direct the camera to a preset position when the camera detects motion

This example explains how to set up the camera to go to a preset position when it detects motion in the image.

Make sure the AXIS Video Motion Detection application is running:

1. Go to **Settings > Apps > AXIS Video Motion Detection**.
2. Start the application if it is not already running.
3. Make sure you have set up the application according to your needs.

Add a preset position:

Go to **Settings > PTZ** and set where you want the camera to be directed by creating a preset position.

Create a rule:

1. Go to **Settings > System > Events > Rules** and add a rule.
2. Type a name for the rule.
3. In the list of conditions, select a video motion detection condition under **Application**.
4. From the list of actions, select **Go to preset position**.
5. Select the preset position you want the camera to go to.
6. Click **Save**.

# AXIS M11 Network Camera Series

## Setup

---

### Send an email automatically if someone spray paints the lens

1. Go to **System > Detectors**.
2. Turn on **Trigger on dark images**. This will trigger an alarm if the lens is sprayed, covered, or rendered severely out of focus.
3. Set a duration for **Trigger after**. The value indicates the time that must pass before an email is sent.

Create a rule:

1. Go to **Events > Rules** and add a rule.
2. Type a name for the rule.
3. In the list of conditions, select **Tampering**.
4. In the list of actions, select **Send notification to email** and then select a recipient from the list. Go to **Recipients** to create a new recipient.
5. Type a subject and a message for the email.
6. Click **Save**.

## Applications

### Applications

AXIS Camera Application Platform (ACAP) is an open platform that enables third parties to develop analytics and other applications for Axis products. To find out more about available applications, downloads, trials and licenses, go to [axis.com/applications](http://axis.com/applications).

To find the user manuals for Axis applications, go to [axis.com](http://axis.com).

#### Note

- Several applications can run at the same time but some applications might not be compatible with each other. Certain combinations of applications might require too much processing power or memory resources when run in parallel. Verify that the applications work together before deployment.

# AXIS M11 Network Camera Series

## Troubleshooting

---

### Troubleshooting

If you can't find what you're looking for here, try the troubleshooting section at [axis.com/support](https://axis.com/support).

### Reset to factory default settings

#### Important

Reset to factory default should be used with caution. A reset to factory default resets all settings, including the IP address, to the factory default values.

To reset the product to the factory default settings:

1. Disconnect power from the product.
2. Press and hold the control button while reconnecting power. See *Product overview on page 4*.
3. Keep the control button pressed for 15–30 seconds until the status LED indicator flashes amber.
4. Release the control button. The process is complete when the status LED indicator turns green. The product has been reset to the factory default settings. If no DHCP server is available on the network, the default IP address is 192.168.0.90.
5. Use the installation and management software tools to assign an IP address, set the password, and access the video stream.

The installation and management software tools are available from the support pages on [axis.com/support](https://axis.com/support).

It is also possible to reset parameters to factory default through the web interface. Go to **Settings > System > Maintenance** and click **Default**.

### Firmware options

Axis offers product firmware management according to either the active track or the long-term support (LTS) tracks. Being on the active track means continuously getting access to all the latest product features, while the LTS tracks provide a fixed platform with periodic releases focused mainly on bug fixes and security updates.

Using firmware from the active track is recommended if you want to access the newest features, or if you use Axis end-to-end system offerings. The LTS tracks are recommended if you use third-party integrations, which are not continuously validated against the latest active track. With LTS, the products can maintain cybersecurity without introducing any significant functional changes or affecting any existing integrations. For more detailed information about Axis product firmware strategy, go to [axis.com/support/firmware](https://axis.com/support/firmware).

### Check the current firmware

Firmware is the software that determines the functionality of network devices. One of your first actions when troubleshooting a problem should be to check the current firmware version. The latest version may contain a correction that fixes your particular problem.

To check the current firmware:

1. Go to the product's webpage.
2. Click on the help menu. 
3. Click **About**.

# AXIS M11 Network Camera Series

## Troubleshooting

---

### Upgrade the firmware

#### Important

Preconfigured and customized settings are saved when the firmware is upgraded (provided that the features are available in the new firmware) although this is not guaranteed by Axis Communications AB.

#### Important

Make sure the product remains connected to the power source throughout the upgrade process.

#### Note

When you upgrade the product with the latest firmware in the active track, the product receives the latest functionality available. Always read the upgrade instructions and release notes available with each new release before upgrading the firmware. To find the latest firmware and the release notes, go to [axis.com/support/firmware](http://axis.com/support/firmware).

1. Download the firmware file to your computer, available free of charge at [axis.com/support/firmware](http://axis.com/support/firmware).
2. Log in to the product as an administrator.
3. Go to **Settings > System > Maintenance**. Follow the instructions on the page. When the upgrade has finished, the product restarts automatically.

AXIS Device Manager can be used for multiple upgrades. Find out more at [axis.com/products/axis-device-manager](http://axis.com/products/axis-device-manager).

### Technical issues, clues and solutions

If you can't find what you're looking for here, try the troubleshooting section at [axis.com/support](http://axis.com/support).

#### Problems upgrading the firmware

---

|                          |   |
|--------------------------|---|
| Firmware upgrade failure | If the firmware upgrade fails, the device reloads the previous firmware. The most common reason is that the wrong firmware file has been uploaded. Check that the name of the firmware file corresponds to your device and try again. |
|--------------------------|---|

#### Problems setting the IP address

---

|   |  |
|---|--|
| The device is located on a different subnet                         | If the IP address intended for the device and the IP address of the computer used to access the device are located on different subnets, you cannot set the IP address. Contact your network administrator to obtain an IP address.  |
| The IP address is being used by another device                      | Disconnect the Axis device from the network. Run the ping command (in a Command/DOS window, type <code>ping</code> and the IP address of the device): <ul style="list-style-type: none"><li>• If you receive: <code>Reply from &lt;IP address&gt;: bytes=32; time=10...</code> this means that the IP address may already be in use by another device on the network. Obtain a new IP address from the network administrator and reinstall the device.</li><li>• If you receive: <code>Request timed out</code>, this means that the IP address is available for use with the Axis device. Check all cabling and reinstall the device.</li></ul> |
| Possible IP address conflict with another device on the same subnet | The static IP address in the Axis device is used before the DHCP server sets a dynamic address. This means that if the same default static IP address is also used by another device, there may be problems accessing the device.  |

#### The device cannot be accessed from a browser

---

|               |   |
|---------------|---|
| Cannot log in | When HTTPS is enabled, ensure that the correct protocol (HTTP or HTTPS) is used when attempting to log in. You may need to manually type <code>http</code> or <code>https</code> in the browser's address field.<br><br>If the password for the user <code>root</code> is lost, the device must be reset to the factory default settings. See <i>Reset to factory default settings on page 19</i> . |
|---------------|---|

# AXIS M11 Network Camera Series

## Troubleshooting

---

|  |   |
|--|---|
| The IP address has been changed by DHCP  | IP addresses obtained from a DHCP server are dynamic and may change. If the IP address has been changed, use AXIS IP Utility or AXIS Device Manager to locate the device on the network. Identify the device using its model or serial number, or by the DNS name (if the name has been configured).<br><br>If required, a static IP address can be assigned manually. For instructions, go to <a href="http://axis.com/support">axis.com/support</a> . |
| Certificate error when using IEEE 802.1X | For authentication to work properly, the date and time settings in the Axis device must be synchronized with an NTP server. Go to <b>Settings &gt; System &gt; Date and time</b> .  |

### The device is accessible locally but not externally

---

To access the device externally, we recommend using one of the following applications for Windows®:

- AXIS Companion: free of charge, ideal for small systems with basic surveillance needs.
- AXIS Camera Station: 30-day trial version free of charge, ideal for small to mid-size systems.

For instructions and download, go to [axis.com/products/axis-companion](http://axis.com/products/axis-companion).

### Problems with streaming

---

|  |   |
|--|---|
| Multicast H.264 only accessible by local clients       | Check if your router supports multicasting, or if the router settings between the client and the device need to be configured. The TTL (Time To Live) value may need to be increased.   |
| No multicast H.264 displayed in the client             | Check with your network administrator that the multicast addresses used by the Axis device are valid for your network.<br><br>Check with your network administrator to see if there is a firewall preventing viewing.   |
| Poor rendering of H.264 images                         | Ensure that your graphics card is using the latest driver. The latest drivers can usually be downloaded from the manufacturer's website.  |
| Color saturation is different in H.264 and Motion JPEG | Modify the settings for your graphics adapter. Go to the adapter's documentation for more information.  |
| Lower frame rate than expected                         | <ul style="list-style-type: none"><li>• See <i>Performance considerations on page 21</i>.</li><li>• Reduce the number of applications running on the client computer.</li><li>• Limit the number of simultaneous viewers.</li><li>• Check with the network administrator that there is enough bandwidth available.</li><li>• Lower the image resolution.</li><li>• The maximum frames per second is dependent on the utility frequency (60/50 Hz) of the Axis device.</li></ul> |

## Performance considerations

When setting up your system, it is important to consider how various settings and situations affect the performance. Some factors affect the amount of bandwidth (the bitrate) required, others can affect the frame rate, and some affect both. If the load on the CPU reaches its maximum, this also affects the frame rate.

The following factors are the most important to consider:

- High image resolution or lower compression levels result in images containing more data which in turn affects the bandwidth.
- Rotating the image in the GUI will increase the product's CPU load.
- Access by large numbers of Motion JPEG or unicast H.264 clients affects the bandwidth.
- Simultaneous viewing of different streams (resolution, compression) by different clients affects both frame rate and bandwidth.

Use identical streams wherever possible to maintain a high frame rate. Stream profiles can be used to ensure that streams are identical.

- Accessing Motion JPEG and H.264 video streams simultaneously affects both frame rate and bandwidth.

# AXIS M11 Network Camera Series

## Troubleshooting

---

- Heavy usage of event settings affects the product's CPU load which in turn affects the frame rate.
- Using HTTPS may reduce frame rate, in particular if streaming Motion JPEG.
- Heavy network utilization due to poor infrastructure affects the bandwidth.
- Viewing on poorly performing client computers lowers perceived performance and affects frame rate.
- Running multiple AXIS Camera Application Platform (ACAP) applications simultaneously may affect the frame rate and the general performance.

# AXIS M11 Network Camera Series

## Specifications

---

### Specifications

To find the latest version of the product's datasheet, go to the product page at [axis.com](http://axis.com) and locate **Support & Documentation**.

### LED indicators

**Note**

The Status LED can be configured to flash while an event is active.

| Status LED | Indication  |
|------------|---|
| Green      | Steady green for normal operation.                      |
| Amber      | Steady during startup. Flashes when restoring settings. |

| Network LED | Indication   |
|-------------|--|
| Green       | Steady for connection to a 100 Mbit/s network. Flashes for network activity. |
| Amber       | Steady for connection to a 10 Mbit/s network. Flashes for network activity.  |
| Unlit       | No network connection.   |

| Power LED | Indication                                   |
|-----------|--|
| Green     | Normal operation.                            |
| Amber     | Flashes green/amber during firmware upgrade. |

### SD card slot

**NOTICE**

- Risk of damage to SD card. Do not use sharp tools, metal objects, or excessive force when inserting or removing the SD card. Use your fingers to insert and remove the card.
- Risk of data loss and corrupted recordings. Do not remove the SD card while the product is running. Unmount the SD card from the product's webpage before removal.

This product supports microSD/microSDHC/microSDXC cards.

For SD card recommendations, see [axis.com](http://axis.com).



microSD, microSDHC, and microSDXC Logos are trademarks of SD-3C LLC. microSD, microSDHC, microSDXC are trademarks or registered trademarks of SD-3C, LLC in the United States, other countries or both.

### Buttons

#### Control button

The control button is used for:

- Resetting the product to factory default settings. See *Reset to factory default settings on page 19*.
- Connecting to an AXIS Video Hosting System service. To connect, press and hold the button for about 3 seconds until the status LED flashes green.

# AXIS M11 Network Camera Series

## Specifications

### Connectors

#### Network connector

RJ45 Ethernet connector with Power over Ethernet (PoE).

#### I/O connector

Use the I/O connector with external devices in combination with, for example, motion detection, event triggering, and alarm notifications. In addition to the 0 V DC reference point and power (DC output), the I/O connector provides the interface to:

**Digital input** – For connecting devices that can toggle between an open and closed circuit, for example PIR sensors, door/window contacts, and glass break detectors.

**Digital output** – For connecting external devices such as relays and LEDs. Connected devices can be activated by the VAPIX® Application Programming Interface or from the product's webpage.

4-pin terminal block

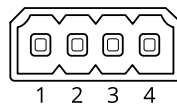

| Function       | Pin | Notes   | Specifications                       |
|----------------|-----|---|--------------------------------------|
| DC ground      | 1   |   | 0 V DC                               |
| DC output      | 2   | Can be used to power auxiliary equipment.<br>Note: This pin can only be used as power out.  | 12 V DC<br>Max load = 25 mA          |
| Digital Input  | 3   | Connect to pin 1 to activate, or leave floating (unconnected) to deactivate.  | 0 to max 30 V DC                     |
| Digital Output | 4   | Internally connected to pin 1 (DC ground) when active, and floating (unconnected) when inactive. If used with an inductive load, e.g., a relay, connect a diode in parallel with the load, to protect against voltage transients. | 0 to max 30 V DC, open drain, 100 mA |

Example

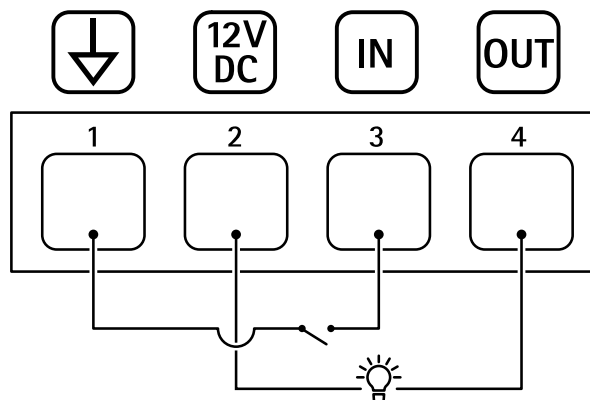

- 1 DC ground
- 2 DC output 12 V, max 25 mA
- 3 Digital input



# AXIS M11 Network Camera Series

## Specifications

---

### 4 *Digital output*

#### **Power connector**

2-pin terminal block for DC power input. Use a Safety Extra Low Voltage (SELV) compliant limited power source (LPS) with either a rated output power limited to  $\leq 100$  W or a rated output current limited to  $\leq 5$  A.

