

INSTALLATION GUIDE

AXIS T8351 Microphone 3.5 mm

Legal Considerations

Video and audio surveillance can be prohibited by laws that vary from country to country. Check the laws in your local region before using this product for surveillance purposes.

Liability

Every care has been taken in the preparation of this document. Please inform your local Axis office of any inaccuracies or omissions. Axis Communications AB cannot be held responsible for any technical or typographical errors and reserves the right to make changes to the product and documentation without prior notice. Axis Communications AB makes no warranty of any kind with regard to the material contained within this document, including, but not limited to, the implied warranties of merchantability and fitness for a particular purpose. Axis Communications AB shall not be liable nor responsible for incidental Support or consequential damages in connection with the furnishing, performance or use of this material. This product is only to be used for its intended purpose.

Notice

Axis' policy is to improve its products as new technology, components, software, and firmware become available. Axis, therefore, reserves the right to change specifications without prior notice.

RoHS

This product complies with both the European RoHS directive, 2002/95/EC, and the Chinese RoHS regulations, ACPEIP.



Safety

This product complies with IEC/EN 60950-1, Safety of Information Technology Equipment.

Support

Should you require any technical assistance, please contact your Axis reseller. If your questions cannot be answered immediately, your reseller will forward your queries through the appropriate channels to ensure a rapid response. If you are connected to the Internet, you can:

- download user documentation and firmware updates
- find answers to problems in the FAQ database. Search by product, category, phrases.
- report problems to Axis support by logging in to your private support area.
- chat with Axis support staff (selected countries only)
- visit Axis Support at www.axis.com/techsup/

WEEE Directive

The European Union has enacted a Directive 2002/96/EC on Waste Electrical and Electronic Equipment (WEEE Directive). This directive is applicable in the European Union member states. The WEEE marking on this product (see right) or its documentation indicates that the product must not be disposed of together with household waste. To prevent possible harm to human health and/or the environment, the product must be disposed of in an approved and environmentally safe recycling process. For further information on how to dispose of this product correctly, contact the product supplier, or the local authority responsible for waste disposal in your area. Business users should contact the product supplier for information on how to dispose of this product correctly. This product should not be mixed with other commercial waste.



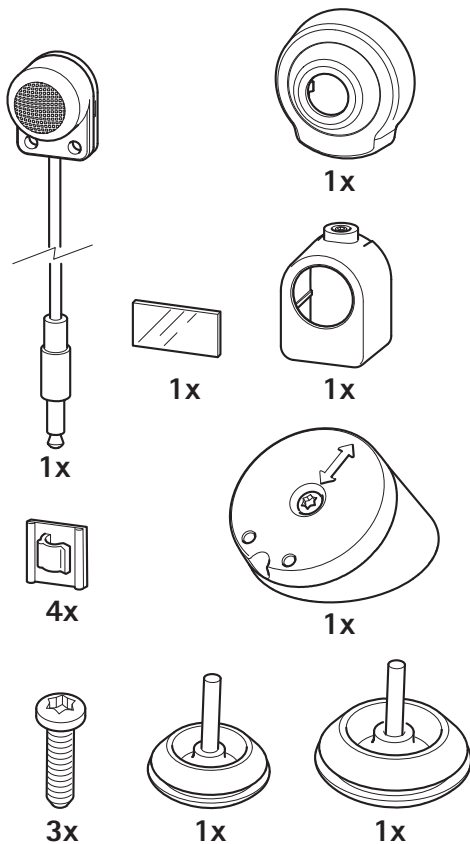

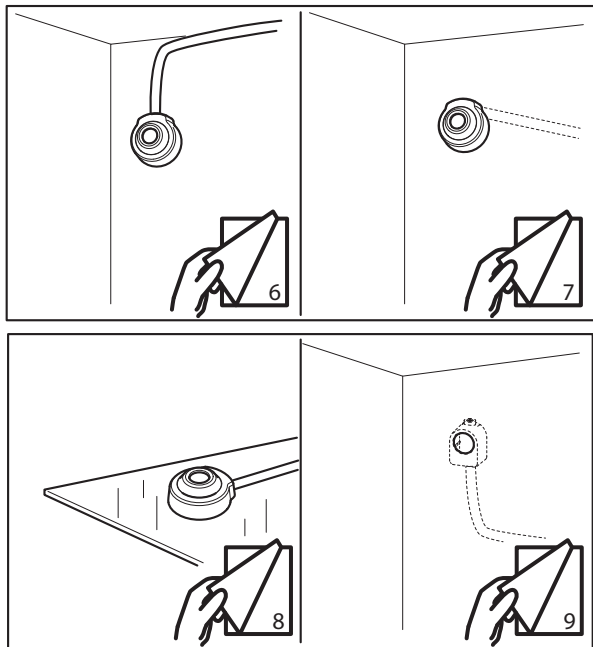

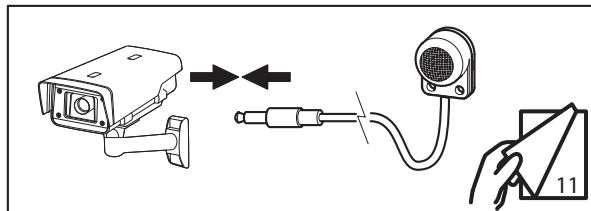
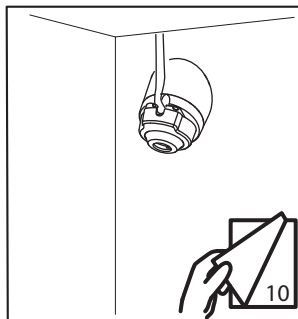

1

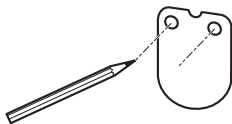

2

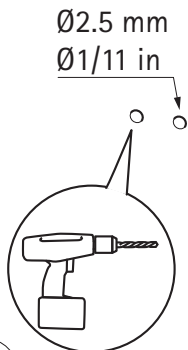

3

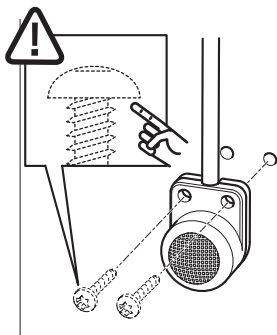

4

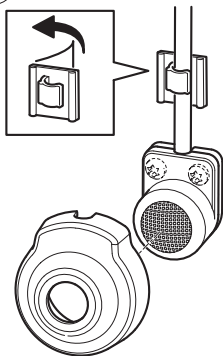

5

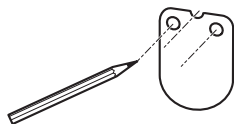

6

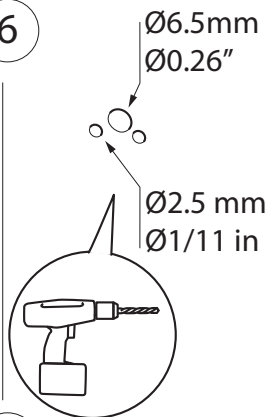

7

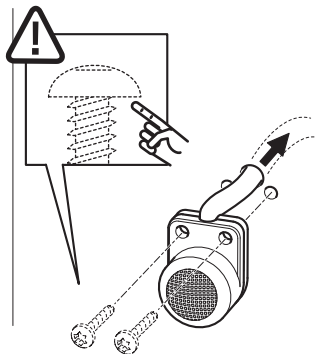

8

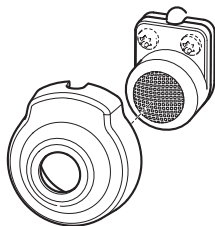

9

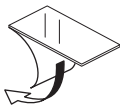

10

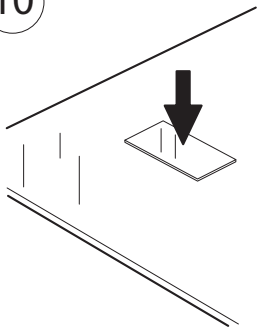

11

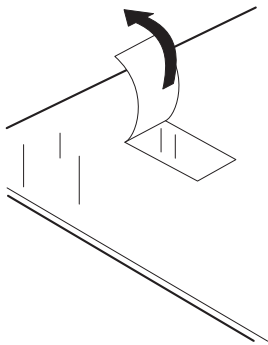

12

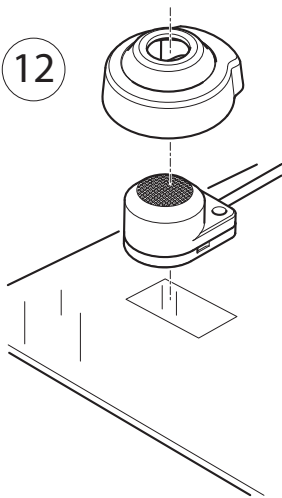

13

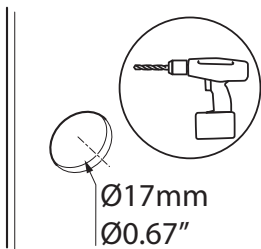

14

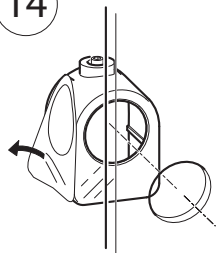

15

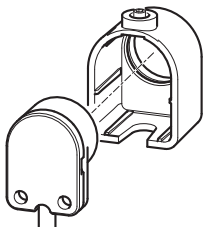

16



17

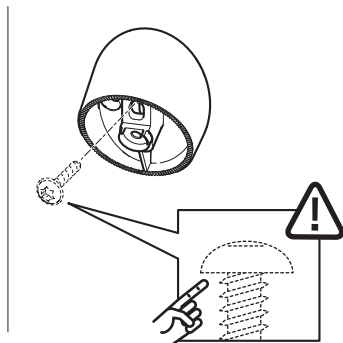

18

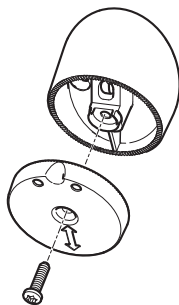

19

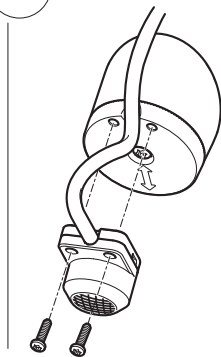

20

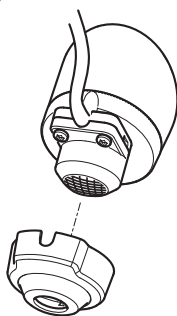

21

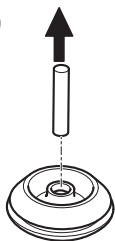

22

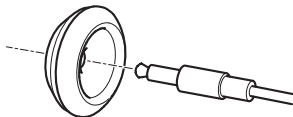

23

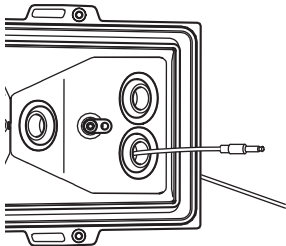
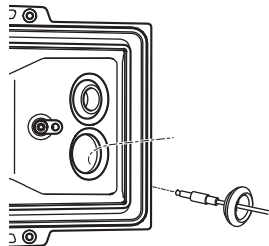
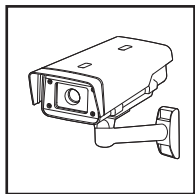

24

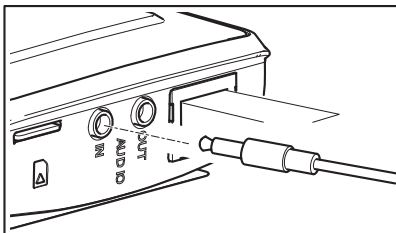

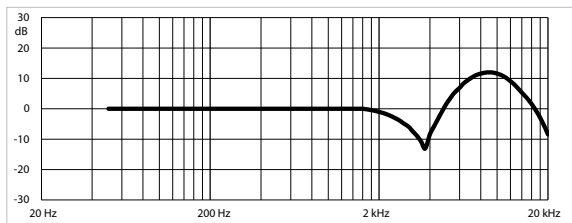



www.axis.com/warranty

Installation Guide

AXIS T8351 Microphone 3.5 mm

© Axis Communications AB, 2013

Ver.1.0

Printed: November 2013

Part No. 50664