

AXIS P3747-PLVE Panoramic Camera

4x5 MP multidirectional with AI analytics

AXIS P3747-PLVE offers four channels with 5 MP per channel at 20 fps. It includes 360° IR illumination with individually controllable LEDs and a removable IR cut filter. All four sensors are fully motorized and PTRZ functionality ensures ease of installation and configuration. Plus, presets make it easy to configure multiple devices. This discreet camera can be mounted on ceilings for complete 360° coverage. Or corner mounted for 270° coverage. It supports advanced analytics on the edge. Furthermore, Axis Edge Vault, a hardware-based cybersecurity platform, safeguards the device and offers FIPS 140-2 Level 2 certified secure key storage and operations.

- > **4x5 MP at 20 fps per channel**
- > **Remote pan, tilt, roll, zoom (PTRZ)**
- > **Support for powerful analytics**
- > **360° IR illumination with individually controlled LEDs**
- > **Built-in cybersecurity with Axis Edge Vault**



AXIS P3747-PLVE Panoramic Camera

Camera

Image sensor

4x 1/2.78" progressive scan RGB CMOS
Pixel size 2.0 µm

Lens

Varifocal, 3.18–7.42 mm, F1.6–2.7
Horizontal field of view: 360° (90°–40° per sensor)
Vertical field of view: 71.5°–30°
Minimum focus distance: 1.5 m (4.9 ft)
Fixed iris, IR corrected, remote zoom and focus

Day and night

Automatic IR-cut filter

Minimum illumination

Color: 0.15 lux at 50 IRE, F1.6
B/W: 0 lux at 50 IRE, F1.6 (with IR on)

Shutter speed

5 MP
WDR on: 1/19500 s to 1 s
WDR off: 1/16000 s to 1 s
Quad HD
WDR on: 1/18000 s to 1 s
WDR off: 1/15000 s to 1 s

Camera adjustment

Pan ±180°, tilt -23° to -150°, roll +5° to -95°

System on chip (SoC)

Model

ARTPEC-8

Memory

4096 MB RAM, 8192 MB Flash

Compute capabilities

Deep learning processing unit (DLPU)

Video

Video compression

H.264 (MPEG-4 Part 10/AVC) Baseline, Main and High Profiles
H.265 (MPEG-H Part 2/HEVC) Main Profile
Motion JPEG

Resolution

4:3 4x 2592x1944 (4x 5 MP) to 4x 640x480
16:9 4x 2560x1440 (4x Quad HD) to 4x 640x360

Frame rate

5 MP: Up to 20/20 fps (50/60 Hz) in all resolutions
Quad HD: Up to 25/30 fps (50/60 Hz) in all resolutions

Video streaming

Multiple, individually configurable streams in H.264, H.265 and Motion JPG
Axis Zipstream technology in H.264 and H.265
Controllable frame rate and bandwidth
VBR/ABR/MBR H.264/H.265
Low latency mode
Video streaming indicator

Signal-to-noise ratio

>55 dB

WDR

Forensic WDR: Up to 120 dB depending on scene

Noise reduction

Spatial filter (2D noise reduction)
Temporal filter (3D noise reduction)

Image settings

Saturation, contrast, brightness, sharpness, white balance, day/night threshold, local contrast, tone mapping, exposure mode, exposure zones, barrel distortion correction, compression, rotation: 0°, 90°, 180°, 270° including corridor format, mirroring, text and image overlay, dynamic text and image overlay, privacy masks, polygon privacy mask

Image processing

Axis Zipstream, Forensic WDR, Lightfinder, OptimizedIR

Audio

Audio features

Speaker pairing

Audio streaming

Two-way (half duplex, full duplex)

Audio input

Input through speaker pairing or portcast technology

Audio output

Output through speaker pairing or portcast technology

Network

Network protocols

IPv4, IPv6 USGv6, ICMPv4/ICMPv6, HTTP, HTTPS¹, HTTP/2, TLS¹, QoS Layer 3 DiffServ, FTP, SFTP, CIFS/SMB, SMTP, mDNS (Bonjour), UPnP®, SNMP v1/v2c/v3 (MIB-II), DNS/DNSv6, DDNS, NTP, NTS, RTSP, RTP, SRTP/RTSPS, TCP, UDP, IGMPv1/v2/v3, RTCP, ICMP, DHCPv4/v6, ARP, SSH, LLDP, CDP, MQTT v3.1.1, Secure syslog (RFC 3164/5424, UDP/TCP/TLS), Link-Local address (ZeroConf)

System integration

Application Programming Interface

Open API for software integration, including VAPIX®, metadata and AXIS Camera Application Platform (ACAP); specifications at axis.com/developer-community. ACAP includes Native SDK and Computer Vision SDK.

One-click cloud connection

ONVIF® Profile G, ONVIF® Profile M, ONVIF® Profile S, and ONVIF® Profile T, specifications at onvif.org

Video management systems

Compatible with AXIS Camera Station Edge, AXIS Camera Station Pro, AXIS Camera Station 5, and video management software from Axis' partners available at axis.com/vms.

Onscreen controls

Autofocus
Video streaming indicator
IR illumination
Privacy masks
Media clip

Edge-to-edge

Speaker pairing

Event conditions

Device status: above/below/within operating temperature, IP address removed, new IP address, network lost, system ready, live stream active, casing open, shock detected

Edge storage: recording ongoing, storage disruption, storage health issues detected

I/O: manual trigger, virtual input

MQTT: stateless

Scheduled and recurring: schedule

Video: average bitrate degradation, day-night mode, tampering

Event actions

Day-night mode

Illumination: use lights, use lights while the rule is active

LEDs: flash status LED, flash status LED while the rule is active

MQTT: publish

Notification: HTTP, HTTPS, TCP and email

Overlay text

Recordings: record, record while the rule is active

Security: erase configuration

SNMP traps: send, send while the rule is active

Upload of images or video clips: FTP, SFTP, HTTP, HTTPS, network share and email

WDR mode

Built-in installation aids

Pixel counter, remote zoom and focus, level grid, barrel distortion correction, preset positions, pan-tilt-roll: designed to withstand at least 200 full movement cycles

Analytics

Applications

Included

AXIS Object Analytics, AXIS Scene Metadata, AXIS Video Motion Detection, active tampering alarm

Supported

Support for AXIS Camera Application Platform enabling installation of third-party applications, see axis.com/acap

Multisensor analytics

4 channels analytics support, AXIS Object Analytics

1. This product includes software developed by the OpenSSL Project for use in the OpenSSL Toolkit. (openssl.org), and cryptographic software written by Eric Young (eay@cryptsoft.com).

AXIS Object Analytics

Object classes: humans, vehicles (types: cars, buses, trucks, bikes, other)

Scenarios: line crossing, object in area, time in area, crossline counting, occupancy in area, motion in area, motion line crossing

Up to 10 scenarios

Other features: triggered objects visualized with trajectories, color-coded bounding boxes and tables

Polygon include/exclude areas

Perspective configuration

ONVIF Motion Alarm event

AXIS Scene Metadata

Object classes: humans, faces, vehicles (types: cars, buses, trucks, bikes), license plates

Object attributes: vehicle color, upper/lower clothing color, confidence, position

Approvals

Product markings

UL/cUL, CE, FCC, ICES, KC, VCCI, RCM, BSMI

Supply chain

TAA compliant

EMC

CISPR 35, CISPR 32 Class A, EN 55035, EN 55032 Class A, EN 50121-4, EN 61000-6-1, EN 61000-6-2

Australia/New Zealand: RCM AS/NZS CISPR 32 Class A

Canada: ICES-3(A)/NMB-3(A)

Japan: VCCI Class A

Korea: KS C 9835, KS C 9832 Class A

USA: FCC Part 15 Subpart B Class A

Taiwan: CNS 15936

Railway: IEC 62236-4

Safety

CAN/CSA C22.2 No. 62368-1 ed. 3, IEC/EN/UL 62368-1 ed. 3, IEC/EN 62471 risk group exempt, RCM AS/NZS 62368.1:2022, IS 13252

Environment

IEC 60068-2-1, IEC 60068-2-2, IEC 60068-2-6, IEC 60068-2-14, IEC 60068-2-27, IEC 60068-2-78, IEC/EN 60529 IP66, IEC/EN 62262 IK10, MIL-STD-810H (Method 501.7, 502.7, 505.7 506.6, 507.6 509.7), NEMA 250 Type 4X, NEMA TS 2 (2.2.7-2.2.9)

Network

NIST SP500-267

Cybersecurity

ETSI EN 303 645, BSI IT Security Label, FIPS 140

Cybersecurity

Edge security

Software: Signed OS, brute force delay protection, digest authentication and OAuth 2.0 RFC6749 OpenID Authorization Code Flow for centralized ADFS account management, password protection, Axis Cryptographic Module (FIPS 140-2 level 1)

Hardware: Axis Edge Vault cybersecurity platform
Secure keystore: TPM 2.0 (CC EAL4+, FIPS 140-2 Level 2), system-on-chip security (TEE)

Axis device ID, signed video, secure boot, encrypted filesystem (AES-XTS-Plain64 256bit)

Network security

IEEE 802.1X (EAP-TLS, PEAP-MSCHAPv2)², IEEE 802.1AE (MACsec PSK/EAP-TLS), IEEE 802.1AR, HTTPS/HSTS², TLS v1.2/v1.3², Network Time Security (NTS), X.509 Certificate PKI, host-based firewall

Documentation

AXIS OS Hardening Guide

Axis Vulnerability Management Policy

Axis Security Development Model

AXIS OS Software Bill of Material (SBOM)

To download documents, go to axis.com/support/cybersecurity/resources

To read more about Axis cybersecurity support, go to axis.com/cybersecurity

General

Casing

IP66-, NEMA 4X- and IK10-rated

Polycarbonate hard-coated dome

Aluminum and plastic casing, polycarbonate (PC) dome

Color: white NCS S 1002-B

For repainting instructions, go to the product's support page. For information about the impact on warranty, go to axis.com/warranty-implication-when-repainting.

Mounting

Mounting bracket with junction box holes (double-gang, single-gang, 4" square, and 4" octagon)

1/2" (M20) conduit side entry

2. This product includes software developed by the OpenSSL Project for use in the OpenSSL Toolkit. (openssl.org), and cryptographic software written by Eric Young (eay@cryptsoft.com).

Power

Power over Ethernet (PoE) IEEE 802.3af/802.3at Type 2 Class 4
Typical 10.8 W, max 23.7 W

Connectors

Network: Shielded RJ45 10BASE-T/100BASE-TX/1000BASE-T PoE
Audio: Audio and I/O connectivity via portcast technology

IR illumination

Optimized IR with power-efficient, long-life 850 nm IR LEDs
Range of reach 20 m (65.6 ft) at 0 lux, 30 m (98.4 ft) at 0.1 lux

Storage

Support for microSD/microSDHC/microSDXC card
Support for SD card encryption (AES-XTS-Plain64 256bit)
Recording to network-attached storage (NAS)
For SD card and NAS recommendations see axis.com

Operating conditions

-40 °C to 50 °C (-40 °F to 122 °F)
Minimum temperature for PTR functionality: -30 °C (-22 °F)
Maximum temperature according to NEMA TS 2 (2.2.7): 74 °C (165 °F)
Start-up temperature: -30 °C
Humidity 10–100% RH (condensing)

Storage conditions

-40 °C to 65 °C (-40 °F to 149 °F)
Humidity 5–95% RH (non-condensing)

Dimensions

For the overall product dimensions, see the dimension drawing in this datasheet.
Effective Projected Area (EPA): 0.030862 m² (0.33 ft²)

Weight

3 kg (6.6 lb)

Box content

Camera, installation guide, connector guard, cable gasket, mounting plate, dome casing

Optional accessories

AXIS TP3107 Pendant Kit, AXIS TP3108-E Pendant Kit, AXIS TP3840-E Dome Casing Black, AXIS TP3841-E Dome Smoked, AXIS T90D Illuminators, AXIS T8415 Wireless Installation Tool, AXIS Surveillance Cards
For more accessories, go to axis.com/products/axis-p3747-plve#accessories

System tools

AXIS Site Designer, AXIS Device Manager, product selector, accessory selector, lens calculator
Available at axis.com

Languages

English, German, French, Spanish, Italian, Russian, Simplified Chinese, Japanese, Korean, Portuguese, Polish, Traditional Chinese, Dutch, Czech, Swedish, Finnish, Turkish, Thai, Vietnamese

Warranty

5-year warranty, see axis.com/warranty

Part numbers

Available at axis.com/products/axis-p3747-plve#part-numbers

Sustainability

Substance control

PVC free, BFR/CFR free in accordance with JEDEC/ECA Standard JS709
RoHS in accordance with EU RoHS Directive 2011/65/EU/ and 2015/863, and standard EN IEC 63000:2018
REACH in accordance with (EC) No 1907/2006. For SCIP UUID, see echa.europa.eu

Materials

Renewable carbon-based plastic content: 40% (recycled: 13%, bio-based: 25%, carbon capture based: 2%)
Screened for conflict minerals in accordance with OECD guidelines
To read more about sustainability at Axis, go to axis.com/about-axis/sustainability

Environmental responsibility

axis.com/environmental-responsibility
Axis Communications is a signatory of the UN Global Compact, read more at unglobalcompact.org

Detect, Observe, Recognize, Identify (DORI)

	DORI definition	Distance (wide)	Distance (tele)
Detect	25 px/m (8 px/ft)	60.5 m (198.4 ft)	147.9 m (485.1 ft)
Observe	63 px/m (19 px/ft)	24 m (78.7 ft)	58.7 m (192.5 ft)
Recognize	125 px/m (38 px/ft)	12.1 m (39.7 ft)	29.6 m (97.1 ft)
Identify	250 px/m (76 px/ft)	6.1 m (20.0 ft)	14.8 m (48.5 ft)

The DORI values are calculated using pixel densities for different use cases as recommended by the EN-62676-4 standard. The calculations use the center of the image as the reference point and consider lens distortion. The possibility to recognize or identify a person or object depends on factors such as object motion, video compression, lighting conditions, and camera focus. Use margins when planning. The pixel density varies across the image, and the calculated values can differ from the distances in the real world.

Dimension drawing

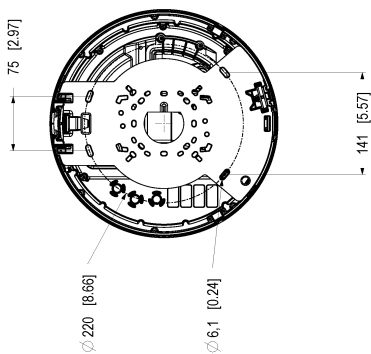
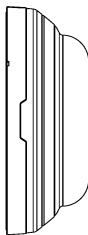
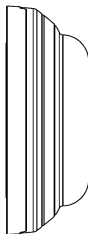
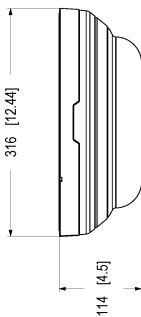
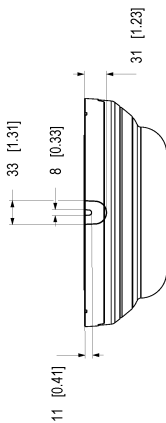
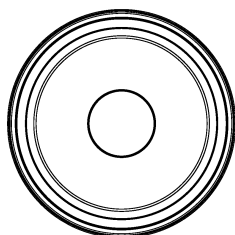
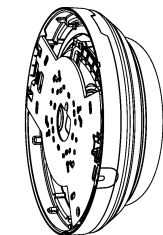

Highlighted capabilities

AXIS Object Analytics

AXIS Object Analytics is a preinstalled, multifeatured video analytics that detects and classifies humans, vehicles, and types of vehicles. Thanks to AI-based algorithms and behavioral conditions, it analyzes the scene and their spatial behavior within – all tailored to your specific needs. Scalable and edge-based, it requires minimum effort to set up and supports various scenarios running simultaneously.

50%. Zipstream also includes three intelligent algorithms, which ensure that relevant forensic information is identified, recorded, and sent in full resolution and frame rate.

For more information, see axis.com/glossary

Axis Edge Vault

Axis Edge Vault is the hardware-based cybersecurity platform that safeguards the Axis device. It forms the foundation that all secure operations depend on and offer features to protect the device's identity, safeguard its integrity and protect sensitive information from unauthorized access. For instance, **secure boot** ensures that a device can boot only with **signed OS**, which prevents physical supply chain tampering. With signed OS, the device is also able to validate new device software before accepting to install it. And the **secure keystore** is the critical building-block for protecting cryptographic information used for secure communication (IEEE 802.1X, HTTPS, Axis device ID, access control keys etc.) against malicious extraction in the event of a security breach. The secure keystore and secure connections are provided through a Common Criteria or FIPS 140 certified hardware-based cryptographic computing module.

Furthermore, signed video ensures that video evidence can be verified as untampered. Each camera uses its unique video signing key, which is securely stored in the secure keystore, to add a signature into the video stream allowing video to be traced back to the Axis camera from where it originated.

To read more about Axis Edge Vault, go to axis.com/solutions/edge-vault.

Pan-tilt-roll-zoom (PTRZ)

PTRZ functionality includes the ability of a camera to rotate around its vertical, lateral, and longitudinal axes. The camera's focal length is adjustable to achieve a narrower or wider field of view. Thanks to the remote functionality, you can quickly adjust and readjust the camera view remotely over the network, saving time and effort. PTRZ functionality also gives you the flexibility to make future adjustments easily, ensuring less disruption, less downtime, and that no dispatched technician is needed.

Zipstream

The Axis Zipstream technology preserves all the important forensic in the video stream while lowering bandwidth and storage requirements by an average of