

AXIS Q6086-E PTZ Camera

Iconic PTZ with 4 MP and great light sensitivity

AXIS Q6086-E features an extremely light-sensitive 1/2" sensor, 34x optical zoom, and laser focus. Built on ARTPEC-9, it supports AV1 codec and offers accelerated performance to run impressive analytics applications on the edge. For instance, AXIS Object Analytics can detect and classify different objects. This IP66-, IK10-, NEMA 4x-, and NEMA TS2-rated camera is both impact and weather-resistant. Axis Zipstream with support for AV1, H.264, and H.265 significantly lowers bandwidth and storage requirements. Furthermore, Axis Edge Vault safeguards your device and protects sensitive information from unauthorized access.

- > [Highly light-sensitive 1/2" sensor](#)
- > [Lightfinder 2.0 and Forensic WDR](#)
- > [Next-generation AI-powered analytics](#)
- > [Precise laser focus and 34x optical zoom](#)
- > [Built-in cybersecurity with Axis Edge Vault](#)



AXIS Q6086-E PTZ Camera

Camera

Image sensor

1/2" progressive scan RGB CMOS
Pixel size: 2.9 µm

Lens

Varifocal, 6.64 - 225.5 mm, F1.7-5.1
Horizontal field of view: 61.5°-2.0°
Vertical field of view: 37.3°-1.1°
Minimum focus distance: 3 m (9.8 ft)
Laser focus, autofocus, P-iris

Day and night

Automatic IR-cut filter
Removable infrared-pass filter

Minimum illumination

Color: 0.07 lux at 30 IRE, F1.7
B/W: 0.005 lux at 30 IRE, F1.7
Color: 0.1 lux at 50 IRE, F1.7
B/W: 0.009 lux at 50 IRE, F1.7

Shutter speed

1/49500 s to 2 s

Pan/Tilt/Zoom

Pan: 360° endless, 0.05°-500°/s
Tilt: 0 to -90°, 0.05°-500°/s
Zoom: 34x optical, 12x digital, total 408x zoom
Nadir flip, 300 preset positions, tour recording (max 10, max duration 16 minutes each), guard tour (max 100), control queue, on-screen directional indicator, orientation aid PTZ, set new pan 0°, adjustable zoom speed

System on chip (SoC)

Model

ARTPEC-9

Memory

4096 MB RAM, 8192 MB Flash

Compute capabilities

Deep learning processing unit (DLPU)

Video

Video compression

H.264 (MPEG-4 Part 10/AVC) Baseline, Main and High Profiles
H.265 (MPEG-H Part 2/HEVC) Main Profile
AV1
Motion JPEG

Resolution

2688x1512 (4MP) to 640x360

Frame rate

Up to 50/60 fps (50/60 Hz) in all resolutions
Automatic switching

Video streaming

Up to 20 unique and configurable video streams¹
Axis Zipstream technology in H.264, H.265 and AV1
Controllable frame rate and bandwidth
VBR/ABR/MBR H.264/H.265/AV1
Low latency mode
Video streaming indicator

Signal-to-noise ratio

>55 dB

WDR

Forensic WDR: Up to 120 dB depending on scene

Noise reduction

Spatial filter (2D noise reduction)
Temporal filter (3D noise reduction)

Image settings

Saturation, contrast, brightness, sharpness, white balance, day/night threshold, local contrast, tone mapping, exposure mode, exposure zones, defog, compression, text and image overlay, overlay widget, 100 individual polygon privacy masks including mosaic and chameleon privacy masks, lock aperture, target aperture
Scene profiles: outdoor, indoor, forensic, traffic overview, license plate

Image processing

Axis Zipstream, Forensic WDR, Lightfinder 2.0

1. We recommend a maximum of 3 unique video streams per camera or channel, for optimized user experience, network bandwidth, and storage utilization. A unique video stream can be served to many video clients in the network using multicast or unicast transport method via built-in stream reuse functionality.

Audio

Input and output through portcast technology accessories or edge-to-edge pairing. For more information, see *Optional accessories* and *Edge-to-edge*.

Network

Network protocols

IPv4, IPv6 USGv6, ICMPv4/ICMPv6, HTTP, HTTPS², HTTP/2, TLS², QoS Layer 3 DiffServ, FTP, SFTP, CIFS/SMB, SMTP, mDNS (Bonjour), UPnP[®], SNMP v1/v2c/v3 (MIB-II), DNS/DNSv6, DDNS, NTP, PTP, NTS, RTSP, RTP, SRTP/RTSPS, TCP, UDP, IGMPv1/v2/v3, RTCP, ICMP, DHCPv4/v6, ARP, SSH, NTCIP, LLDP, CDP, MQTT v3.1.1, Secure syslog (RFC 3164/5424, UDP/TCP/TLS), Link-Local address (ZeroConf)

System integration

Application Programming Interface

Open API for software integration, including VAPIX[®], metadata and AXIS Camera Application Platform (ACAP); specifications at axis.com/developer-community.

One-click cloud connection

ONVIF[®] Profile G, ONVIF[®] Profile M, ONVIF[®] Profile S, and ONVIF[®] Profile T, specifications at onvif.org

Video management systems

Compatible with AXIS Camera Station Edge, AXIS Camera Station Pro, AXIS Camera Station 5, and video management software from Axis' partners available at axis.com/vms.

Onscreen controls

Privacy masks
Day/night shift
Quick zoom
Autotracking
Defog
Heater
Orientation aid
Media clip

Edge-to-edge

Speaker pairing
Radar pairing

Event conditions

Device status: above/below/within operating temperature, fan failure, IP address blocked/removed, live stream active, network lost, new IP address, shock detected, system ready
Edge storage: recording ongoing, storage disruption, storage health issues detected
I/O: manual trigger, virtual input is active
MQTT: MQTT client connected
PTZ: PTZ control queue, PTZ malfunctioning, PTZ movement, PTZ preset position reached, PTZ ready
Scheduled and recurring: schedule
Video: average bitrate degradation, day-night mode

Event actions

Day-night mode
Defog
Guard tour: run guard tour while the rule is active, start guard tour
Guard tour (recorded): run recorded guard tour while the rule is active
MQTT: send MQTT publish message
Notification: HTTP, HTTPS, TCP and email
Overlay text
Preset positions: go to preset position, go to preset position while the rule is active
Recordings: record video, record video while the rule is active
Security: erase configuration
SNMP trap messages: send, send while the rule is active
Tracking: start temporary detection, toggle autotracking/autotracking profile, toggle autotracking/autotracking profile while the rule is active
Images or video clips: FTP, SFTP, HTTP, HTTPS, network share and email
WDR mode

Built-in installation aids

Pixel counter, level grid

Analytics

Applications

Included

AXIS Object Analytics, AXIS Image Health Analytics, AXIS Scene Metadata, AXIS Live Privacy Shield³, AXIS Video Motion Detection, autotracking, active gatekeeper

Supported

AXIS People Counter

Support for AXIS Camera Application Platform enabling installation of third-party applications, see axis.com/acap

2. This product includes software developed by the OpenSSL Project for use in the OpenSSL Toolkit. (openssl.org), and cryptographic software written by Eric Young (ey@cryptsoft.com).

3. Available for download

AXIS Object Analytics

Object classes: humans, vehicles (types: cars, buses, trucks, bikes, other)

Scenarios: line crossing, object in area, time in area, crossline counting, occupancy in area, tailgating detection, PPE monitoring^{BETA}, motion in area, motion line crossing

Up to 10 scenarios

Other features: triggered objects visualized with trajectories, color-coded bounding boxes and tables

Polygon include/exclude areas

Perspective configuration

ONVIF Motion Alarm event

AXIS Image Health Analytics

Detection settings:

Tampering: blocked image, redirected image

Image degradation: blurred image, underexposed image

Other features: sensitivity, validation period

AXIS Scene Metadata

Object classes: humans, faces, vehicles (types: cars, buses, trucks, bikes), license plates

Object attributes: vehicle color, upper/lower clothing color, confidence, position

Approvals

Product markings

CE, FCC, ICES, KC, VCCI

Supply chain

TAA compliant

EMC

CISPR 35, CISPR 32 Class A, EN 55035,

EN 55032 Class A, EN 50121-4, EN 61000-3-2,

EN 61000-3-3, EN 61000-6-1, EN 61000-6-2

Australia/New Zealand: RCM AS/NZS CISPR 32 Class A

Canada: ICES-3(A)/NMB-3(A)

Japan: VCCI Class A

Korea: KS C 9835, KS C 9832 Class A

USA: FCC Part 15 Subpart B Class A

Railway: IEC 62236-4

Safety

CAN/CSA C22.2 No. 62368-1 ed. 3,

IEC/EN/ 60825-1 Class 1, IEC/EN/UL 62368-1 ed. 3,

RCM AS/NZS 62368.1:2022

Environment

IEC 60068-2-1, IEC 60068-2-2, IEC 60068-2-6,

IEC 60068-2-14, IEC 60068-2-27, IEC 60068-2-78,

IEC/EN 60529 IP66/IP67, IEC/EN 62262 IK10,

ISO 21207 (Method B), ISO 12944-6: C5, NEMA 250

Type 4X, NEMA TS 2 (2.2.7-2.2.9), MIL-STD-810H

(Method 501.7, 502.7, 505.7, 506.6, 507.6, 509.7, 510.7, 512.6, 521.4)

Network

NIST SP500-267

Cybersecurity

ETSI EN 303 645, BSI IT Security Label, FIPS 140

Cybersecurity

Edge security

Software: Signed OS, brute force delay protection, digest authentication and OAuth 2.0 RFC6749 Client Credential Flow/OpenID Authorization Code Flow for centralized ADFS account management, password protection, Axis Cryptographic Module (FIPS 140-3 level 3)

Hardware: Axis Edge Vault cybersecurity platform

Secure keystore: secure element (CC EAL 6+, FIPS 140-3 Level 3), system-on-chip security (TEE)

Axis device ID, signed video, secure boot, encrypted filesystem (AES-XTS-Plain64 256bit)

Network security

IEEE 802.1X (EAP-TLS, PEAP-MSCHAPv2)⁴,

IEEE 802.1AE (MACsec PSK/EAP-TLS), IEEE 802.1AR,

HTTPS/HSTS⁴, TLS v1.2/v1.3⁴, Network Time Security

(NTS), X.509 Certificate PKI, host-based firewall

Documentation

AXIS OS Hardening Guide

Axis Vulnerability Management Policy

Axis Security Development Model

AXIS OS Software Bill of Material (SBOM)

To download documents, go to axis.com/support/cybersecurity/resources

To read more about Axis cybersecurity support, go to axis.com/cybersecurity

4. This product includes software developed by the OpenSSL Project for use in the OpenSSL Toolkit. (openssl.org), and cryptographic software written by Eric Young (ey@cryptsoft.com).

General

Casing

IP66-, IP67-, NEMA 4X- and IK10-rated
Polycarbonate hard-coated dome
Aluminum casing
Color: white NCS S 1002-B
For repainting instructions, go to the product's support page. For information about the impact on warranty, go to axis.com/warranty-implication-when-repainting.

Power

Power over Ethernet (PoE) IEEE 802.3bt, Class 6
Typical 10 W, max 51 W
Features: dynamic power mode, power profiles, power meter

Connectors

Network: RJ45 10BASE-T/100BASE-TX/1000BASE-T PoE
RJ45 Push-pull Connector (IP66/IP67)

Storage

Support for SD/SDHC/SDXC card
Support for SD card encryption (AES-XTS-Plain64 256bit)
Recording to network-attached storage (NAS)
For SD card and NAS recommendations see axis.com

Operating conditions

Full power with 60 W midspan: -50 °C to 55 °C (-58 °F to 131 °F)
Maximum temperature according to NEMA TS 2 (2.2.7): 74 °C (165 °F)
Arctic temperature control: Start-up as low as -40 °C (-40 °F)
Humidity: 10–100% RH (condensing)

Storage conditions

-40 °C to 65 °C (-40 °F to 149 °F)
Humidity 5-95% RH (non-condensing)

Dimensions

For the overall product dimensions, see the dimension drawing in this datasheet.
Effective Projected Area (EPA): 0.046 m² (0.5 ft²)

Weight

4100 g (9 lb)

Box content

Camera, weathershield, installation guide, 90 W Midspan (including power cable)⁵, RJ45 Push-pull Connector (IP66), owner authentication key

System tools

AXIS Site Designer, AXIS Device Manager, product selector, accessory selector, lens calculator
Available at axis.com

Languages

English, German, French, Spanish, Italian, Russian, Simplified Chinese, Japanese, Korean, Portuguese, Polish, Traditional Chinese, Dutch, Czech, Swedish, Finnish, Turkish, Thai, Vietnamese

Warranty

5-year warranty, see axis.com/warranty

Software support

New feature development until 2030 (AXIS OS 12, 13 and 14)
Support until 2035-12-31 (AXIS OS LTS 2030–2035)
Read more about the AXIS OS lifecycle at help.axis.com/axis-os

Part numbers

Available at axis.com/products/axis-q6086-e#part-numbers

Optional accessories

Portcast

AXIS TU8003 90 W Connectivity Midspan

Installation

AXIS T8415 Wireless Installation Tool

Mounting

AXIS T91/T94/TQ Mounting Accessories

Storage

AXIS Surveillance Cards

Smoked dome

For more accessories, go to axis.com/products/axis-q6086-e#compatible-products

Sustainability

Substance control

PVC free, BFR/CFR free in accordance with JEDEC/ECA Standard JS709
RoHS in accordance with EU RoHS Directive 2011/65/EU and 2015/863, and standard EN IEC 63000:2018
REACH in accordance with (EC) No 1907/2006. For SCIP UUID, see echa.europa.eu

5. Not included for AXIS Q6086-E NM

Materials

Renewable carbon-based plastic content: 71%
(recycled: 1%, bio-based: 70%)

Screened for conflict minerals in accordance with OECD guidelines

To read more about sustainability at Axis, go to [axis.com/about-axis/sustainability](https://www.axis.com/about-axis/sustainability)

Environmental responsibility

[axis.com/environmental-responsibility](https://www.axis.com/environmental-responsibility)

Axis Communications is a signatory of the UN Global Compact, read more at unglobalcompact.org

Power-optimized performance

Power

PoE, IEEE 802.3bt, Class 6

Low power profile: typical 10 W, max 25.5 W

PoE, IEEE 802.3at, Class 4

Full power profile: typical 10 W, max 25.5 W

Low power profile: typical 10 W, max 25.5 W

Operating conditions

Full power profile with 30 W midspan: -20 °C to 55 °C (-4 °F to 131 °F)

Low power profile with 30 W or 60 W midspan: -20 °C to 55 °C (-4 °F to 131 °F)

Detect, Observe, Recognize, Identify (DORI)

	DORI definition	Distance (wide)	Distance (tele)
Detect	25 px/m (8 px/ft)	92.6 m (303.7 ft)	3118.4 m (10228.4 ft)
Observe	63 px/m (19 px/ft)	36.7 m (120.4 ft)	1237.5 m (4059.0 ft)
Recognize	125 px/m (38 px/ft)	18.5 m (60.7 ft)	623.6 m (2045.4 ft)
Identify	250 px/m (76 px/ft)	9.3 m (30.5 ft)	311.8 m (1022.7 ft)

The DORI values are calculated using pixel densities for different use cases as recommended by the EN-62676-4 standard. The calculations use the center of the image as the reference point and consider lens distortion. The possibility to recognize or identify a person or object depends on factors such as object motion, video compression, lighting conditions, and camera focus. Use margins when planning. The pixel density varies across the image, and the calculated values can differ from the distances in the real world.

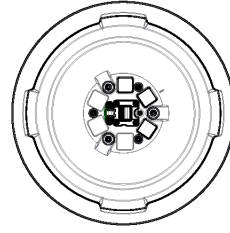
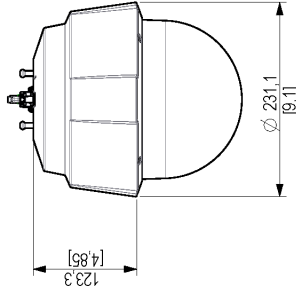
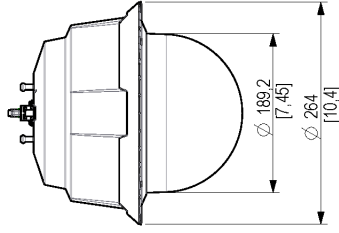
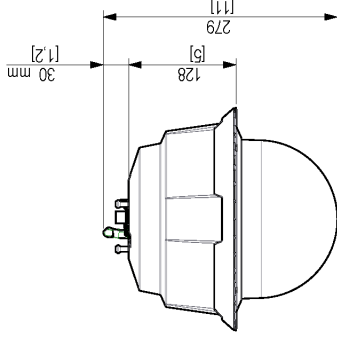
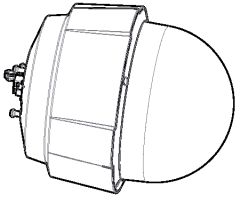
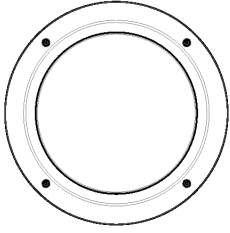
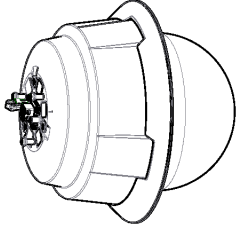

Dimensions in mm [inch]	
Date	Version
2025 Apr-11	M1.3
3196527	1.5
3196527	Sheet
A3	1(1)

SCALE 1:5

Q608X PTZ Camera



© 2025 Axis Communications AB. All rights reserved.

Highlighted capabilities

AV1

AV1 is a modern video encoding standard optimized for video transmission over the internet by Alliance for Open Media (AoM). It was designed to provide better compression efficiency than older codecs including H.264 (also known as AVC) and H.265 (HEVC), while being royalty-free and open-source.

AXIS Object Analytics

AXIS Object Analytics is a preinstalled, multifeatured video analytics that detects and classifies humans, vehicles, and types of vehicles. Thanks to AI-based algorithms and behavioral conditions, it analyzes the scene and their spatial behavior within – all tailored to your specific needs. Scalable and edge-based, it requires minimum effort to set up and supports various scenarios running simultaneously.

Laser focus

Laser focus helps cameras find focus even faster than cameras with autofocus only. It finds focus in challenging lighting conditions, such as scenes with low light or contrast. The out-of-the-box-ready feature is a fully automatic solution, requiring neither setting nor programming to work. As soon as the camera is turned on, the laser focus starts working. The laser focus feature includes a laser that assists focusing by providing a reference point. The laser module has a transmitter and a receiver. The transmitter sends out a laser ray that bounces off an object and returns to the receiver, providing the camera with a focus reference point. The IR light of the laser focus is neither visible nor harmful, and has a wavelength of 905 nm. The laser focus feature verifies focus continuously when the scene changes. Since the camera already knows the distance to the object, it knows where to start searching, and the entire process is performed automatically within a fraction of a second.

For more information, see axis.com/glossary