

AXIS M2048-LE Bullet Camera

Affordable AI-powered 8 MP camera with IR

AXIS M2048-LE offers great 4K image quality in challenging light conditions. Its wide 126° horizontal field of view covers large areas. AXIS Object Analytics can detect, classify, track, and count humans and vehicles. It includes a built-in weathershield and can handle tough weather and hurricane winds. This easy to install camera features a spacious, sealed back box for secure cable management. It's ready to mount outdoors and indoors on walls and ceilings. Axis Edge Vault safeguards the device and offers FIPS 140-3 Level 3 certified secure key storage and operations. Furthermore, selected markets feature direct installation view in AXIS Installer app.

- > [Great image quality in 8 MP](#)
- > [Compact lightweight design](#)
- > [Forensic WDR and Lightfinder](#)
- > [AI-powered video analytics](#)
- > [Built-in cybersecurity with Axis Edge Vault](#)



AXIS M2048-LE Bullet Camera

Camera

Image sensor

1/1.8" progressive scan RGB CMOS
Pixel size 2.0 μm

Lens

3.7 mm, F2.0
Horizontal field of view: 126°
Vertical field of view: 67°
Minimum focus distance: 1.0 m (3.3 ft)
Fixed iris, IR corrected

Day and night

Automatic IR-cut filter
Hybrid IR filter

Minimum illumination

Color: 0.18 lux at 50 IRE, F2.0
B/W: 0.04 lux at 50 IRE, F2.0
0 lux with IR illumination on

Shutter speed

1/66,000 s to 1/5 s

Camera adjustment

Pan $\pm 180^\circ$, tilt -90 to 0°, rotation -135 to +225°

System on chip (SoC)

Model

CV75

Memory

2 GB RAM, 8 GB Flash

Compute capabilities

Deep learning processing unit (DLPU)

Video

Video compression

H.264 (MPEG-4 Part 10/AVC) Baseline, Main and High Profiles
H.265 (MPEG-H Part 2/HEVC) Main Profile
Motion JPEG

Resolution

16:9: 3840x2160 to 640x360
4:3: 1440x1080 to 320x240

Frame rate

Up to 15 fps (50/60 Hz) in all resolutions

Video streaming

Multiple, individually configurable streams in H.264, H.265 and Motion JPEG
Axis Zipstream technology in H.264 and H.265
Controllable frame rate and bandwidth
VBR/ABR/MBR H.264/H.265

WDR

Forensic WDR: Up to 120 dB depending on scene

Multi-view streaming

Up to 2 individually cropped out view areas

Image settings

Saturation, contrast, brightness, sharpness, white balance, day/night threshold, local contrast, tone mapping, exposure mode, exposure zones, compression, rotation: 0°, 90°, 180°, 270° including corridor format, mirroring, text and image overlay, dynamic text and image overlay, overlay widget, privacy masks

Image processing

Axis Zipstream, Forensic WDR, Lightfinder, OptimizedIR

Pan/Tilt/Zoom

Digital PTZ, preset positions

Audio

Input and output through edge-to-edge pairing. For more information, see *Optional accessories* and *Edge-to-edge*.

Network

Network protocols

IPv4, IPv6 USGv6, ICMPv4/ICMPv6, HTTP, HTTPS¹, HTTP/2, TLS¹, QoS Layer 3 DiffServ, FTP, SFTP, CIFS/SMB, SMTP, mDNS (Bonjour), UPnP[®], SNMP v1/v2c/v3 (MIB-II), DNS/DNSv6, DDNS, NTP, NTS, PTP, RTSP, RTP, SRTP/RTSPS, TCP, UDP, IGMPv1/v2/v3, RTCP, ICMP, DHCPv4/v6, ARP, SSH, LLDP, CDP, MQTT v3.1.1, Secure syslog (RFC 3164/5424, UDP/TCP/TLS), Link-Local address (ZeroConf)

System integration

Application Programming Interface

Open API for software integration, including VAPIX[®], metadata and AXIS Camera Application Platform (ACAP); specifications at axis.com/developer-community.

One-click cloud connection

ONVIF[®] Profile G, ONVIF[®] Profile M, ONVIF[®] Profile S, and ONVIF[®] Profile T, specifications at onvif.org

Video management systems

Compatible with AXIS Camera Station Edge, AXIS Camera Station Pro, AXIS Camera Station 5, and video management software from Axis' partners available at axis.com/vms.

Onscreen controls

IR illumination
Privacy masks
Media clip
Heater

Edge-to-edge

Microphone pairing
Speaker pairing
Siren and light pairing

Event conditions

Device status: above/below/within operating temperature, audit logs, IP address blocked/removed, live stream active, network lost, new IP address, system ready

Digital audio: digital signal contains Axis metadata, digital signal has invalid sample rate, digital signal missing, digital signal okay

Edge storage: recording ongoing, storage disruption, storage health issues detected

I/O: manual trigger, virtual input is active

MQTT: MQTT client connected

Scheduled and recurring: schedule

Video: average bitrate degradation, day-night mode, tampering

Event actions

Day-night mode

Illumination: use lights, use lights while the rule is active

Images: FTP, SFTP, HTTP, HTTPS, network share and email

LEDs: flash status LED, flash status LED while the rule is active

MQTT: send MQTT publish message

Notification: HTTP, HTTPS, TCP and email

Overlay text

Recordings: record audio, record audio while the rule is active

Security: erase configuration

SNMP trap messages: send, send while the rule is active

Video clips: FTP, SFTP, HTTP, HTTPS, network share and email

WDR mode

Built-in installation aids

Pixel counter, level grid

Analytics

Applications

Included

AXIS Object Analytics, AXIS Image Health Analytics, AXIS Scene Metadata, AXIS Live Privacy Shield², AXIS Video Motion Detection

Supported

Support for AXIS Camera Application Platform enabling installation of third-party applications, see axis.com/acap

1. This product includes software developed by the OpenSSL Project for use in the OpenSSL Toolkit. (openssl.org), and cryptographic software written by Eric Young (ey@cryptsoft.com).
2. Available for download

AXIS Object Analytics

Object classes: humans, vehicles (types: cars, buses, trucks, bikes, other)

Scenarios: line crossing, object in area, time in area, crossline counting, occupancy in area, tailgating detection, PPE monitoring^{BETA}, motion in area, motion line crossing

Up to 10 scenarios

Other features: triggered objects visualized with color-coded bounding boxes

Polygon include/exclude areas

Perspective configuration

ONVIF Motion Alarm event

AXIS Image Health Analytics

Detection settings:

Tampering: blocked image, redirected image

Image degradation: blurred image, underexposed image

Other features: sensitivity, validation period

AXIS Scene Metadata

Object classes: humans, faces, vehicles (types: cars, buses, trucks, bikes), license plates

Object attributes: vehicle color, upper/lower clothing color, bag, confidence, position

Approvals

Product markings

UL/cUL, CE, KC, EAC, VCCI, RCM, RSM, TELEC, BSMI

Supply chain

TAA compliant

EMC

CISPR 35, CISPR 32 Class B, EN 55035, EN 55032 Class B, EN 61000-6-1, EN 61000-6-2, EN 61000-6-3

Australia/New Zealand: RCM AS/NZS CISPR 32 Class B

Canada: ICES(B)/NMB(B)

Japan: VCCI Class B

Korea: KS C 9835, KS C 9832 Class B

USA: FCC Part 15 Subpart B Class B

Taiwan: CNS 15936

Safety

CAN/CSA C22.2 No. 62368-1 ed. 3, IEC/EN/UL 62368-1 ed. 3, IEC/EN 62471 risk group exempt, RCM AS/NZS 62368.1:2022

Environment

IEC 60068-2-1, IEC 60068-2-2, IEC 60068-2-6, IEC 60068-2-14, IEC 60068-2-27, IEC 60068-2-78, IEC/EN 60529 IP66/IP67, IEC/EN 62262 IK08, NEMA 250 Type 4X

Wireless

EN 300328³, EN 301489-1³, EN 301489-17³, FCC Part 15 Subpart C³, RSS-247³

Network

NIST SP500-267

Cybersecurity

ETSI EN 303 645, BSI IT Security Label, FIPS 140, EN 18031-1³

Cybersecurity

Edge security

Software: Signed OS, brute force delay protection, digest authentication and OAuth 2.0 RFC6749 Client Credential Flow/OpenID Authorization Code Flow for centralized ADFS account management, password protection, Axis Cryptographic Module (FIPS 140-2 level 1)

Hardware: Axis Edge Vault cybersecurity platform
Secure keystore: secure element (CC EAL 6+, FIPS 140-3 Level 3), system-on-chip security (TEE)
Axis device ID, signed video, secure boot, encrypted filesystem (AES-XTS-Plain64 256bit)

Network security

IEEE 802.1X (EAP-TLS, PEAP-MSCHAPv2)⁴, IEEE 802.1AE (MACsec PSK/EAP-TLS), IEEE 802.1AR, HTTPS/HSTS⁴, TLS v1.2/v1.3⁴, Network Time Security (NTS), X.509 Certificate PKI, host-based firewall

Documentation

AXIS OS Hardening Guide

Axis Vulnerability Management Policy

Axis Security Development Model

AXIS OS Software Bill of Material (SBOM)

To download documents, go to axis.com/support/cybersecurity/resources

To read more about Axis cybersecurity support, go to axis.com/cybersecurity

3. Not available in all markets.

4. This product includes software developed by the OpenSSL Project for use in the OpenSSL Toolkit. (openssl.org), and cryptographic software written by Eric Young (eay@cryptsoft.com).

General

Casing

IP66/IP67-, NEMA 4X- and IK08-rated
Aluminum and plastic casing
Color: white NCS S 1002-B

Power

Power over Ethernet (PoE) IEEE 802.3af/802.3at Type 1
Class 3, max 12.95 W, typical (heater off, IR off) 3.7 W
Features: dynamic power mode, power meter

Wireless interface

Bluetooth® 5.4 Low Energy⁵ ⁶
Bluetooth profiles: none⁶
Features: direct installation view through AXIS Installer
mobile app⁶

Environmental sensors

Environmental sensors through portcast technology
accessories. For more information, see *Optional
accessories*.

Connectors

Network: Shielded RJ45 10BASE-T/100BASE-TX/
1000BASE-T PoE

IR illumination

Optimized IR with power-efficient, long-life 855 nm IR
LEDs
Range of reach 20 m (65.6 ft) or more depending on the
scene

Storage

Support for microSD/microSDHC/microSDXC card
Support for SD card encryption (AES-XTS-Plain64
256bit)
Recording to network-attached storage (NAS)
For SD card and NAS recommendations see *axis.com*

Operating conditions

Temperature: -30 °C to 55 °C (-22 °F to 131 °F)
Humidity: 10–100% RH (condensing)

Storage conditions

Temperature: -40 °C to 65 °C (-40 °F to 149 °F)
Humidity: 5–95% RH (non-condensing)

Dimensions

For the overall product dimensions, see the dimension
drawing in this datasheet.
Effective Projected Area (EPA): 0.011 m² (0.12 ft²)

Weight

490 g (1.1 lb)

Box content

Camera, installation guide, drill template, connector
guard, cable gaskets, owner authentication key

System tools

AXIS Site Designer, AXIS Device Manager, product
selector, accessory selector, lens calculator
Available at *axis.com*

Languages

English, German, French, Spanish, Italian, Russian,
Simplified Chinese, Japanese, Korean, Portuguese,
Polish, Traditional Chinese, Dutch, Czech, Swedish,
Finnish, Turkish, Thai, Vietnamese

Warranty

5-year warranty, see *axis.com/warranty*

Software support

New feature development until 2030 (AXIS OS 12, 13
and 14)
Support until 2035-12-31 (AXIS OS LTS 2030–2035)
Read more about the AXIS OS lifecycle at *help.axis.com/
axis-os*

Part numbers

Available at *axis.com/products/axis-m2048-le#part-
numbers*

Optional accessories

Portcast

AXIS D6210 Air Quality Sensor

Installation

AXIS T8415 Wireless Installation Tool

Storage

AXIS Surveillance Cards

For more accessories, go to *axis.com/products/axis-
m2048-le#compatible-products*

5. The Bluetooth® word mark and logos are registered trademarks owned by Bluetooth SIG, Inc. and any use of such marks by Axis Communications AB is under license. Other trademarks and trade names are those of their respective owners.

6. Not available in all markets.

Sustainability

Substance control

PVC free, BFR/CFR free in accordance with JEDEC/ECA Standard JS709

RoHS in accordance with EU RoHS Directive 2011/65/EU and 2015/863, and standard EN IEC 63000:2018

REACH in accordance with (EC) No 1907/2006. For SCIP UUID, see echa.europa.eu

Materials

Renewable carbon-based plastic content: 42% (recycled)

Screened for conflict minerals in accordance with OECD guidelines

To read more about sustainability at Axis, go to axis.com/about-axis/sustainability

Environmental responsibility

axis.com/environmental-responsibility

Axis Communications is a signatory of the UN Global Compact, read more at unglobalcompact.org

Detect, Observe, Recognize, Identify (DORI)

	DORI definition	Distance
Detect	25 px/m (8 px/ft)	72.9 m (239.1 ft)
Observe	63 px/m (19 px/ft)	28.9 m (94.8 ft)
Recognize	125 px/m (38 px/ft)	14.6 m (47.9 ft)
Identify	250 px/m (76 px/ft)	7.3 m (23.9 ft)

The DORI values are calculated using pixel densities for different use cases as recommended by the EN-62676-4 standard. The calculations use the center of the image as the reference point and consider lens distortion. The possibility to recognize or identify a person or object depends on factors such as object motion, video compression, lighting conditions, and camera focus. Use margins when planning. The pixel density varies across the image, and the calculated values can differ from the distances in the real world.

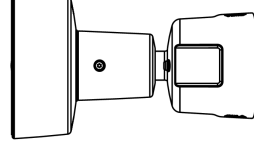
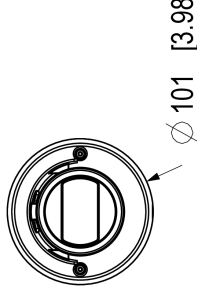
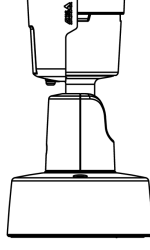
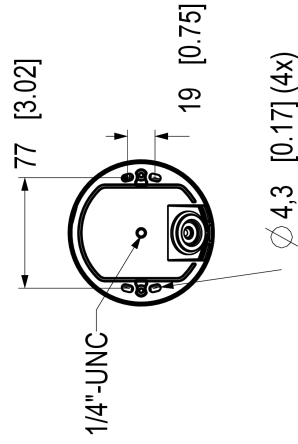
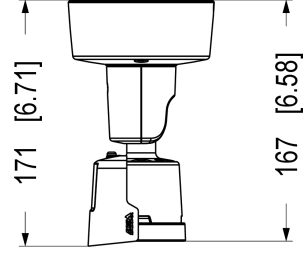
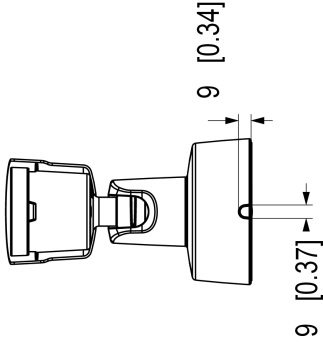
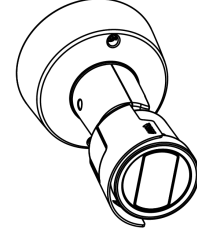

© 2025 Axis Communications AB. All rights reserved.

AXIS M2048-LE Bullet Camera

Dimensions in mm [incht]			
Date	Version	Scale	Sheet
2025 Dec-29	M12	1:3	13
Drawing Number	Size	Sheet	
3601566	A3	1(1)	

Highlighted capabilities

Axis Edge Vault

Axis Edge Vault is the hardware-based cybersecurity platform that safeguards the Axis device. It forms the foundation that all secure operations depend on and offer features to protect the device's identity, safeguard its integrity and protect sensitive information from unauthorized access. For instance, **secure boot** ensures that a device can boot only with **signed OS**, which prevents physical supply chain tampering. With signed OS, the device is also able to validate new device software before accepting to install it. And the **secure keystore** is the critical building-block for protecting cryptographic information used for secure communication (IEEE 802.1X, HTTPS, Axis device ID, access control keys etc.) against malicious extraction in the event of a security breach. The secure keystore and secure connections are provided through a Common Criteria or FIPS 140 certified hardware-based cryptographic computing module.

Furthermore, signed video ensures that video evidence can be verified as untampered. Each camera uses its unique video signing key, which is securely stored in the secure keystore, to add a signature into the video stream allowing video to be traced back to the Axis camera from where it originated.

To read more about Axis Edge Vault, go to axis.com/solutions/edge-vault.

AXIS Image Health Analytics

This embedded AI-powered software is an intelligent application that runs directly on an Axis camera to proactively monitor and maintain its own image quality. It automatically detects common issues like blurry images, camera obstruction or tampering and scene deviations that could compromise the video's usability and sends an alert, allowing for quick and efficient troubleshooting. AXIS Image Health Analytics can also detect light malfunctions, alerting you if the scene is too dark for the camera to produce a clear image. The application is preinstalled at no extra cost and integrates with your video management system (VMS) to enable timely maintenance actions. This saves significant time and resources compared to performing manual inspections.

AXIS Object Analytics

AXIS Object Analytics is a preinstalled, multifeatured video analytics that detects and classifies humans, vehicles, and types of vehicles. Thanks to AI-based algorithms and behavioral conditions, it analyzes the scene and their spatial behavior within – all tailored to your specific needs. Scalable and edge-based, it requires minimum effort to set up and supports various scenarios running simultaneously.

Direct installation view

Direct installation view is a camera feature that enables fast setup using Bluetooth® technology to view the camera stream in real time during the installation phase.

OptimizedIR

Axis OptimizedIR provides a unique and powerful combination of camera intelligence and sophisticated LED technology, resulting in our most advanced camera-integrated IR solutions for complete darkness. In our pan-tilt-zoom (PTZ) cameras with OptimizedIR, the IR beam automatically adapts and becomes wider or narrower as the camera zooms in and out to make sure that the entire field of view is always evenly illuminated.

Zipstream

The Axis Zipstream technology preserves all the important forensic in the video stream while lowering bandwidth and storage requirements by an average of 50%. Zipstream also includes three intelligent algorithms, which ensure that relevant forensic information is identified, recorded, and sent in full resolution and frame rate.

For more information, see axis.com/glossary