

# AXIS T8341 PIR Motion Sensor



## Installation Guide

## **Read this first**

Read through this Installation Guide carefully before installing the product. Keep the Installation Guide for future reference.

## **Legal considerations**

Video and audio surveillance can be regulated by laws that vary from country to country. Check the laws in your local region before using this product for surveillance purposes.

## **Liability**

Every care has been taken in the preparation of this document. Please inform your local Axis office of any inaccuracies or omissions. Axis Communications AB cannot be held responsible for any technical or typographical errors and reserves the right to make changes to the product and manuals without prior notice. Axis Communications AB makes no warranty of any kind with regard to the material contained within this document, including, but not limited to, the implied warranties of merchantability and fitness

for a particular purpose. Axis Communications AB shall not be liable nor responsible for incidental or consequential damages in connection with the furnishing, performance or use of this material. This product is only to be used for its intended purpose.

## **Equipment modifications**

This equipment must be installed and used in strict accordance with the instructions given in the user documentation. This equipment contains no user-serviceable components. Unauthorized equipment changes or modifications will invalidate all applicable regulatory certifications and approvals.

## **Trademark acknowledgements**

AXIS COMMUNICATIONS, AXIS and VAPIX are registered trademarks or trademark applications of Axis AB in various jurisdictions. All other company names and products are trademarks or registered trademarks of their respective companies.

Z-Wave and Z-Wave Plus are registered trademarks of Silicon Laboratories Inc. in the United States and other countries.

## **Regulatory information**

### **Electromagnetic compatibility (EMC)**

This equipment has been designed and tested to fulfill applicable standards for:

- Radio frequency emission when installed according to the instructions and used in its intended environment.
- Immunity to electrical and electromagnetic phenomena when installed according to the instructions and used in its intended environment.

### **USA**

This equipment has been tested and found to comply with the limits for a Class B digital device, pursuant to part 15 of the FCC Rules. These limits are designed to provide reasonable protection against harmful interference in a residential installation. This

equipment generates, uses and can radiate radio frequency energy and, if not installed and used in accordance with the instructions, may cause harmful interference to radio communications. However, there is no guarantee that interference will not occur in a particular installation. If this equipment does cause harmful interference to radio or television reception, which can be determined by turning the equipment off and on, the user is encouraged to try to correct the interference by one or more of the following measures:

- Reorient or relocate the receiving antenna.
- Increase the separation between the equipment and receiver.
- Consult the dealer or an experienced radio/TV technician for help.

### **Canada**

This digital apparatus complies with CAN ICES-3 (Class B). Cet appareil numérique est conforme à la norme CAN NMB-3 (classe B).

### **Japan**

この装置は、クラスB 情報技術装置です。この装置は、家庭環境で使用することを目的としていますが、この装置がラジオやテレビジョン受信機に近接して使用されると、受信障害を引き起こすことがあります。取扱説明書に従って正しい取り扱いをして下さい。

Europe



This product is intended for indoor use only.

This product complies with the applicable CE marking directives and harmonized standards:

- Radio Equipment Directive (RED) 2014/53/EU.
- Restriction of Hazardous Substances (RoHS) Directive 2011/65/EU, including any amendments, updates or replacements.

A copy of the original declaration of conformity may be obtained from Axis Communications AB. See *Contact information on page 12.*

## **Radio transmission**

This equipment may generate or use radio frequency energy. The user could lose the authority to operate this equipment if an unauthorized change or modification is made.

### **USA**

This equipment complies with the limits for a Class B digital device, pursuant to part 15 of the FCC Rules. Operation is subject to the following two conditions: (1) this device may not cause harmful interference, and (2) this device must accept any interference received, including interference that may cause undesirable operation.

This product complies with FCC radiation exposure limits for an uncontrolled environment. This equipment shall be installed and operated with a minimum distance of 20 cm (7.9 in) between the user and the device.

## Canada

This device complies with Industry Canada licence-exempt RSS standard(s). Operation is subject to the following two conditions: (1) this device may not cause interference, and (2) this device must accept any interference, including interference that may cause undesired operation of the device.

This product complies with IC radiation exposure limits for an uncontrolled environment. This equipment shall be installed and operated with a minimum distance of 20 cm (7.9 in) between the user and the device.

Le présent appareil est conforme aux CNR d'Industrie Canada applicables aux appareils radio exempts de licence. L'exploitation est autorisée aux deux conditions suivantes : (1) l'appareil ne doit pas produire de brouillage, et (2) l'utilisateur de l'appareil doit accepter tout brouillage radioélectrique subi, même si le brouillage est susceptible d'en compromettre le fonctionnement.

Ce produit est conforme aux limites d'exposition aux radiations IC pour un environnement non contrôlé. L'équipement doit être installé et fonctionné à



une distance minimum de 20 cm (7,9 po) entre l'utilisateur et le dispositif.

## **Japan**

本製品は、特定無線設備の技術基準適合証明を受けています。

## **Europe**

Hereby, Axis Communications AB declares that this product is in compliance with the essential requirements and other relevant provisions of Directive 2014/53/EU.

## **FR**

Par la présente Axis Communications AB déclare que l'appareil ce produit est conforme aux exigences essentielles et aux autres dispositions pertinentes de la directive 2014/53/CE.

## **DE**

Hiermit erklärt Axis Communications AB, dass sich dieses Produkt in Übereinstimmung mit den

grundlegenden Anforderungen und den anderen relevanten Vorschriften der Richtlinie 2014/53/EG befindet.

## IT

Con la presente Axis Communications AB dichiara che questo prodotto è conforme ai requisiti essenziali ed alle altre disposizioni pertinenti stabilite dalla direttiva 2014/53/CE.

## ES

Por medio de la presente Axis Communications AB declara que el este producto cumple con los requisitos esenciales y cualesquiera otras disposiciones aplicables o exigibles de la Directiva 2014/53/CE.

## FI

Axis Communications AB vakuuttaa täten että tämä tuote tyyppinen laite on direktiivin 2014/53/EY oleellisten vaatimusten ja sitä koskevien direktiivin muiden ehtojen mukainen.

## NL

Hierbij verklaart Axis Communications AB dat het toestel in overeenstemming is met de essentiële eisen en de andere relevante bepalingen van richtlijn 2014/53/EG.

## SV

Härmed intygar Axis Communications AB att denna produkt står i överensstämmelse med de väsentliga egenskapskrav och övriga relevanta bestämmelser som framgår av direktiv 2014/53/EG.

## DA

Undertegnede Axis Communications AB erklærer herved, at følgende udstyr overholder de væsentlige krav og øvrige relevante krav i direktiv 2014/53/EF.

## PT

Axis Communications AB declara que este produto está conforme com os requisitos essenciais e outras disposições da Directiva 2014/53/CE.

EL

ΜΕ ΤΗΝ ΠΑΡΟΥΣΑ Axis Communications  
ΑΒ ΔΗΛΩΝΕΙ ΟΤΙ αυτό το προϊόν  
ΣΥΜΜΟΡΦΩΝΕΤΑΙ ΠΡΟΣ ΤΙΣ ΟΥΣΙΩΔΕΙΣ  
ΑΠΑΙΤΗΣΕΙΣ ΚΑΙ ΤΙΣ ΛΟΙΠΕΣ ΣΧΕΤΙΚΕΣ  
ΔΙΑΤΑΞΕΙΣ ΤΗΣ ΟΔΗΓΙΑΣ 2014/53/ΕΚ.

## **Disposal and recycling**

When this product has reached the end of its useful life, dispose of it according to local laws and regulations. For information about your nearest designated collection point, contact your local authority responsible for waste disposal. In accordance with local legislation, penalties may be applicable for incorrect disposal of this waste.

## **Contact information**

Axis Communications AB  
Emdalavägen 14  
223 69 Lund  
Sweden

Tel: +46 46 272 18 00

Fax: +46 46 13 61 30

*axis.com*

## Warranty information

For information about Axis' product warranty and thereto related information, go to *axis.com/warranty*

## Support

Should you require any technical assistance, please contact your Axis reseller. If your questions cannot be answered immediately, your reseller will forward your queries through the appropriate channels to ensure a rapid response. If you are connected to the Internet, you can:

- find answers to resolved problems in the FAQ database, search by product, category, or phrase
- report problems to Axis support staff by logging in to your private support area

- chat with Axis support staff
- visit Axis Support at *axis.com/support*

## **Learn more!**

Visit Axis learning center *axis.com/academy* for useful trainings, webinars, tutorials and guides.

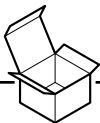

**1x**



**1x**

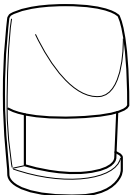

**1x**



**1x**



**2x**



**2x**

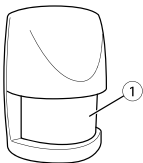

- 1 *PIR sensor window (LED indicator inside)*
- 1 *Capteur infrarouge passif pour fenêtre (voyant DEL à l'intérieur)*
- 1 *PIR-Sensorfenster (LED-Anzeige innerhalb)*
- 1 *Finestra del sensore PIR (indicatore LED all'interno)*
- 1 *Ventana del sensor PIR (indicador LED en el interior)*



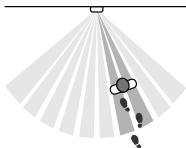
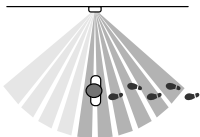

Install the motion sensor in an area where the logical path of an intruder would cut across the detection pattern rather than go directly towards it.



Do not install the motion sensor where it would:

- face a window or be exposed to direct sunlight
- be exposed to ventilation, heat sources or vibrations
- monitor an area where animals may be passing

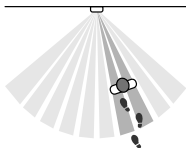
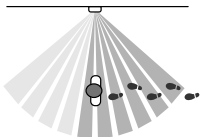

Installez le capteur de mouvement dans une zone où le cheminement logique d'un intrus couperait le rayon de détection plutôt que d'aller directement vers celui-ci.



Ne pas installer le capteur de mouvement à un endroit où il pourrait être exposé à :

- une fenêtre ou aux rayons directs du soleil ;
- un système de ventilation ; des sources de chaleur ou des vibrations ;
- un endroit où des animaux domestiques pourraient passer.

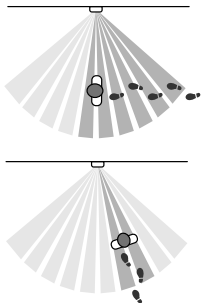

Installieren Sie den Bewegungssensor in einem Bereich, bei dem der logische Pfad eines Eindringlings das Erkennungsmuster durchschneiden und nicht direkt zum Sensor führen würde.



Installieren Sie den Bewegungs- sensor nicht an diesen Stellen:

- gegenüber einem Fenster oder direkter Sonneneinstrahlung ausgesetzt
- Luftzug, Wärmequellen, oder Vibrationen ausgesetzt
- zur Überwachung eines Bereichs, den möglicherweise Tiere passieren.

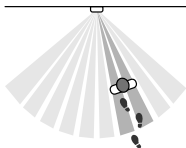
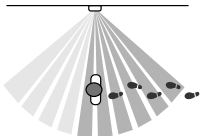

Installare il sensore di movimento in un punto in cui il percorso logico di un intruso tagli il percorso di rilevamento piuttosto che attraversarlo direttamente.



Non installare il sensore di movimento:

- di fronte a una finestra o esposto alla luce solare diretta
- esposto a ventilazione, fonti di calore o vibrazioni
- in modo da monitorare un'area con passaggio di animali.



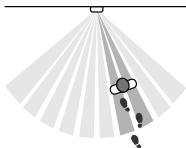
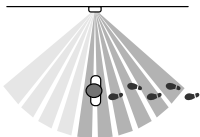

Instale el sensor de movimiento en una zona en la que la ruta lógica de un intruso atravesaría el patrón de detección en lugar de ir directamente hacia él.



No instale el sensor de movimiento donde:

- esté frente a una ventana o expuesto directamente a la luz solar;
- esté expuesto a ventilación, fuentes de calor o vibraciones;
- supervise una zona en la que estén pasando animales.

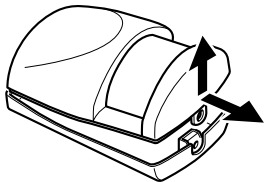
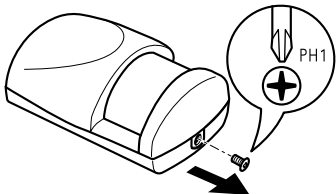

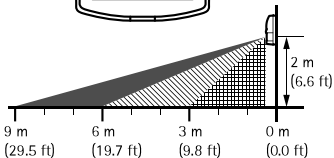
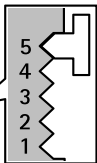
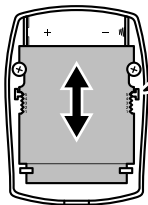

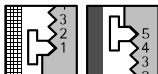

0 5 10 15 20 25 30 (ft)

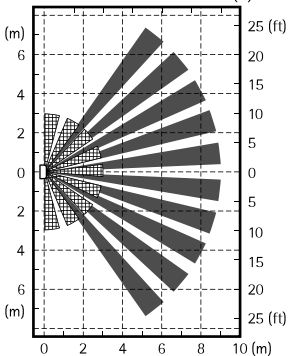

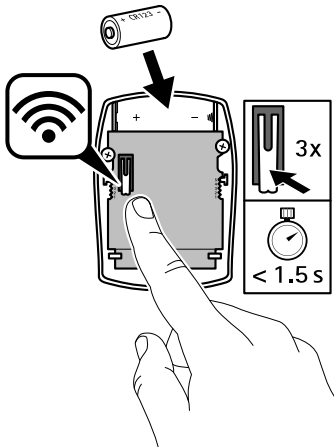

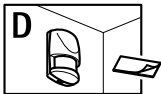
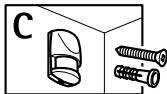
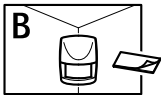
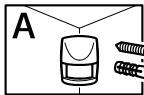

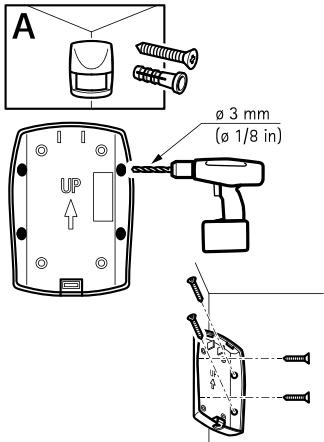



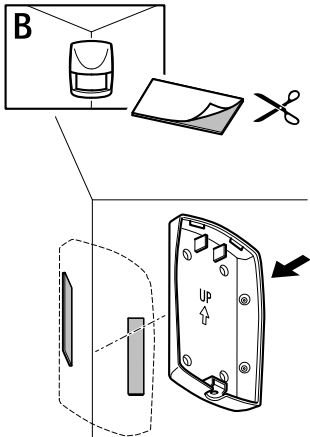

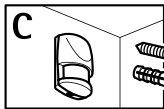

ø 3 mm  
(ø 1/8 in)

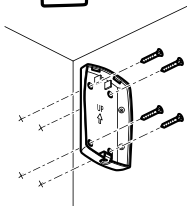
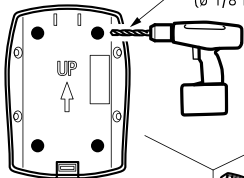

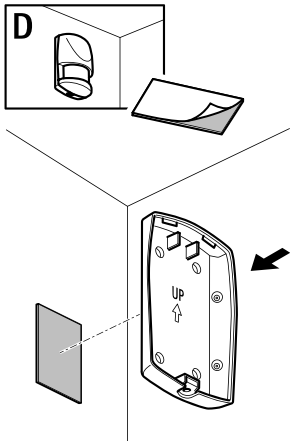

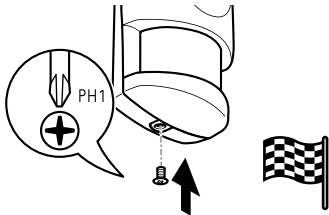
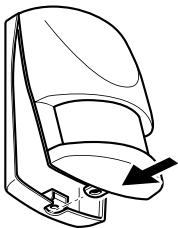

## Note

For more information on operating the product, see the User Manual at [axis.com](http://axis.com)

## Further information

- For the latest version of this document, see *axis.com*
- For useful online trainings and webinars, see *axis.com/academy*

# Safety instructions

## **NOTICE**

- The Axis product shall be used in compliance with local laws and regulations.
- Store the Axis product in a dry and ventilated environment.
- Avoid exposing the Axis product to shocks or heavy pressure.
- Avoid exposing the Axis product to vibration.
- Use only applicable tools when installing the Axis product. Using excessive force with power tools could cause damage to the product.
- Do not use chemicals, caustic agents, or aerosol cleaners.
- Use a clean cloth dampened with pure water for cleaning.
- Use only accessories that comply with the technical specification of your product. These can be provided by Axis or a third party. Axis

recommends using Axis power source equipment compatible with your product.

- Use only spare parts provided by or recommended by Axis.
- Do not attempt to repair the product yourself. Contact Axis support or your Axis reseller for service matters.

## Transportation

### **NOTICE**

- When transporting the Axis product, use the original packaging or equivalent to prevent damage to the product.

## Consignes de sécurité

### **NOTICE**

- Le produit Axis doit être utilisé conformément aux lois et règlements locaux.
- Conserver ce produit Axis dans un environnement sec et ventilé.



- Ne pas exposer ce produit Axis aux chocs ou aux fortes pressions.
- Ne pas exposer ce produit Axis aux vibrations.
- Utiliser uniquement des outils recommandés pour l'installation de l'appareil Axis. L'application d'une force excessive sur l'appareil avec des outils puissants pourrait l'endommager.
- Ne pas utiliser de produits chimiques, de substances caustiques ou de nettoyeurs pressurisés.
- Utiliser un chiffon propre imbibé d'eau pure pour le nettoyage.
- Utiliser uniquement des accessoires conformes aux caractéristiques techniques de votre produit. Ils peuvent être fournis par Axis ou un tiers. Axis recommande d'utiliser un équipement d'alimentation Axis compatible avec votre produit.
- Utiliser uniquement les pièces de rechange fournies ou recommandées par Axis.

- Ne pas essayer de réparer vous-même ce produit. Contacter l'assistance technique d'Axis ou votre revendeur Axis pour des problèmes liés à l'entretien.

## Transport

### **NOTICE**

- Lors du transport du produit Axis, utilisez l'emballage d'origine ou un équivalent pour éviter d'endommager le produit.

## Sicherheitsanweisungen

### **NOTICE**

- Das Axis-Produkt muss unter Beachtung der geltenden Gesetze und Bestimmungen betrieben werden.
- Lagern Sie das Axis Produkt in einer trockenen und belüfteten Umgebung.
- Das Axis-Produkt weder Stößen noch starkem Druck aussetzen.

- Das Axis-Produkt keinen Schwingungen aussetzen.
- Verwenden Sie bei der Installation des Axis Produkts ausschließlich passende Werkzeuge. Ein zu großer Kraftaufwand mit elektrischen Werkzeugen kann das Produkt beschädigen.
- Verwenden Sie keine chemischen, ätzenden oder aerosolhaltigen Reinigungsmittel.
- Verwenden Sie zum Reinigen ein sauberes, mit destilliertem Wasser angefeuchtetes Tuch.
- Verwenden Sie nur Zubehör, das den technischen Vorgaben Ihres Produkts entspricht. Dieses ist von Axis oder Drittanbietern erhältlich. Axis empfiehlt die mit Ihrem Produkt kompatible Stromversorgung von Axis.
- Verwenden Sie ausschließlich Ersatzteile die von Axis angeboten oder empfohlen werden.
- Versuchen Sie nicht, dieses Produkt selbsttätig zu reparieren. Wenden Sie sich bezüglich Reparatur

und Wartung an den Axis Support oder Ihren Axis Händler.

## Transport

### **NOTICE**

- Bei Bedarf transportieren Sie das Axis Produkt in der Originalverpackung oder einer entsprechenden Verpackung, so dass Schäden vermieden werden.

## Informazioni di sicurezza

### **NOTICE**

- Il dispositivo Axis deve essere utilizzato in conformità alle leggi e alle normative locali.
- Conservare il dispositivo Axis in un ambiente asciutto e ventilato.
- Evitare di esporre il dispositivo Axis a urti o pressioni eccessive.
- Evitare di esporre il dispositivo Axis a vibrazione.

- Utilizzare solo strumenti applicabili quando si installa il dispositivo Axis. Se si utilizza una forza eccessiva con strumenti non adatti è possibile causare danni al dispositivo.
- Non utilizzare sostanze chimiche, agenti caustici o detergenti aerosol.
- Utilizzare un panno pulito inumidito in acqua pura per la pulizia.
- Utilizzare solo accessori compatibili con le specifiche tecniche del dispositivo. Questi possono essere forniti da Axis o da terze parti. Axis consiglia l'uso dell'apparecchiatura di alimentazione Axis compatibile con il dispositivo.
- Utilizzare solo parti di ricambio fornite o consigliate da Axis.
- Non tentare di riparare il dispositivo da soli. Contattare l'assistenza o il rivenditore Axis per questioni relative alla manutenzione.

## Trasporto

### **NOTICE**

- Durante il trasporto del dispositivo Axis, utilizzare l'imballaggio originale o equivalente per evitare danni al dispositivo.

## Instrucciones de seguridad

### **NOTICE**

- Este producto de Axis debe utilizarse de acuerdo con las leyes y normativas locales.
- Almacene el producto de Axis en un entorno seco y ventilado.
- Evite la exposición del producto de Axis a choques o a una fuerte presión.
- Evite la exposición del producto de Axis a vibraciones.
- Utilice solo las herramientas correspondientes cuando instale el producto de Axis. La aplicación

de una fuerza excesiva con herramientas eléctricas puede provocar daños en el producto.

- No utilice limpiadores en aerosol, agentes cáusticos ni productos químicos.
- Limpie con un paño limpio humedecido con agua pura.
- Utilice solo accesorios que cumplan con las especificaciones técnicas de su producto. Estos accesorios los puede proporcionar Axis o un tercero. Axis recomienda utilizar un equipo de suministro de alimentación de Axis compatible con su producto.
- Utilice solo piezas de repuesto proporcionadas o recomendadas por Axis.
- No intente reparar el producto usted mismo. Póngase en contacto con el servicio de asistencia técnica de Axis o con su distribuidor de Axis para tratar asuntos de reparación.

## Transporte

### **NOTICE**

- Cuando transporte el producto de Axis, utilice el embalaje original o un equivalente para evitar daños en el producto.





## Installation Guide

AXIS T8341 PIR Motion Sensor

© Axis Communications AB, 2017 - 2019

Ver. M5.2

Date: February 2019

Part No. 1960849