

## AXIS A46

AXIS A4610

AXIS A4612

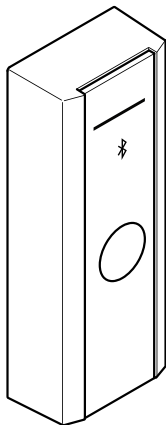

**Installation guide**  
**Guide d'installation**  
**Installationsanleitung**  
**Guida all'installazione**  
**Guía de instalación**  
**インストールガイド**  
**Guia de instalação**  
**РУКОВОДСТВО ПО УСТАНОВКЕ**  
**설치가이드**  
**安裝指南**  
**Panduan instalasi**  
**Kurulum kılavuzu**

## Read this first

Read through this installation guide carefully before you install the product. Keep the installation guide for future reference.

## Legal considerations

Video and audio surveillance can be regulated by laws that vary from country to country. Check the laws in your local region before using this product for surveillance purposes.

## Liability

Every care has been taken in the preparation of this document. Please inform your local Axis office of any inaccuracies or omissions. Axis Communications AB cannot be held responsible for any technical or typographical errors and reserves the right to make changes to the product and manuals without prior notice. Axis Communications AB makes no warranty of any kind with regard to the material contained within this document, including, but not limited to, the implied warranties of merchantability and fitness for a particular purpose. Axis Communications AB shall not be liable nor responsible for incidental or consequential damages in connection with the furnishing, performance or use of this material. This product is only to be used for its intended purpose.

## Intellectual property rights

Axis AB has intellectual property rights relating to technology embodied in the product described in this document. In particular, and without limitation, these intellectual property rights may include one or more of the patents listed at [axis.com/patent](http://axis.com/patent) and one or more additional patents or pending patent applications in the US and other countries.

## Equipment modifications

This equipment must be installed and used in strict accordance with the instructions given in the user documentation. This equipment contains no user-serviceable components. Unauthorized equipment changes or modifications will invalidate all applicable regulatory certifications and approvals.

## Trademark acknowledgements

AXIS COMMUNICATIONS, AXIS, ARTPEC and VAPIX are registered trademarks of Axis AB in various jurisdictions. All other trademarks are the property of their respective owners.

The Bluetooth® word mark and logos are registered trademarks owned by Bluetooth SIG, Inc. and any use of such marks by Axis Communications AB is under license. Other trademarks and trade names are those of their respective owners.

## Regulatory information



This product complies with the applicable CE marking directives:

- Radio Equipment Directive (RED) 2014/53/EU. See *Radio transmission, on page 3.*
- Restriction of Hazardous Substances (RoHS) Directive 2011/65/EU and 2015/863, including any amendments, updates or replacements. See *Disposal and recycling, on page 4.*

A copy of the original declaration of conformity may be obtained from Axis Communications AB. See *Contact information, on page 5.*

### Electromagnetic compatibility (EMC)

This equipment has been designed and tested to fulfill applicable standards for:

- Radio frequency emission when installed according to the instructions and used in its intended environment.
- Immunity to electrical and electromagnetic phenomena when installed according to the instructions and used in its intended environment.

### USA

This device complies with part 15 of the FCC Rules. Operation is subject to the following two conditions:

1. This device may not cause harmful interference, and

2. this device must accept any interference received, including interference that may cause undesired operation.

#### Contact information

Axis Communications Inc.  
300 Apollo Drive  
Chelmsford, MA 01824  
United States of America  
Tel: +1 978 614 2000

#### Canada

This digital apparatus complies with CAN ICES-3 (Class B). The product shall be properly grounded. Cet appareil numérique est conforme à la norme CAN NMB-3 (classe B). Le produit doit être correctement mis à la terre.

#### Europe

This digital equipment fulfills the requirements for RF emission according to the Class B limit of EN 55032. The product shall be properly grounded.

#### Australia/New Zealand

This digital equipment fulfills the requirements for RF emission according to the Class B limit of AS/NZS CISPR 32. The product shall be properly grounded.

#### Japan

この装置は、クラスB機器です。この装置は、住宅環境で使用することを目的としていますが、この装置がラジオやテレビジョン受信機に近接して使用されると、受信障害を引き起こすことがあります。取扱説明書に従って正しい取り扱いをして下さい。VCCI-B

#### Korea

이 기기는 가정용(B급) 전자파적합기기로서 주로 가정에서 사용하는 것을 목적으로 하며, 모든 지역에서 사용할 수 있습니다. 제품은 적합하게 접지 되어야 합니다.

#### Radio transmission

This equipment may generate or use radio frequency energy. The user could lose the authority to operate this equipment if an unauthorized change or modification is made.

#### USA

This product complies with FCC radiation exposure limits for an uncontrolled environment.

#### Canada

This device complies with Innovation, Science and Economic Development Canada licence-exempt RSS standard(s). Operation is subject to the following two conditions: (1) this device may not cause interference, and (2) this device must accept any interference, including interference that may cause undesired operation of the device.

This device complies with IC radiation exposure limits for an uncontrolled environment.

Le présent appareil est conforme aux CNR Innovation, Sciences et Développement économique Canada applicables aux appareils radio exempts de licence. L'exploitation est autorisée aux deux conditions suivantes : (1) l'appareil ne doit pas produire de brouillage, et (2) l'utilisateur de l'appareil doit accepter tout brouillage radioélectrique subi, même si le brouillage est susceptible d'en compromettre le fonctionnement.

Ce produit est conforme aux limites d'exposition aux radiations IC pour un environnement non contrôlé.

#### Europe

Hereby, Axis Communications AB declares that this product is in compliance with the essential requirements and other relevant provisions of Directive 2014/53/EU.

#### FR

Par la présente Axis Communications AB déclare que l'appareil ce produit est conforme aux exigences essentielles et aux autres dispositions pertinentes de la directive 2014/53/UE.

#### DE

Hiermit erklärt Axis Communications AB, dass sich dieses Produkt in Übereinstimmung mit den grundlegenden Anforderungen und den anderen relevanten Vorschriften der Richtlinie 2014/53/EU befindet.

#### IT

Con la presente Axis Communications AB dichiara che questo prodotto è conforme ai requisiti essenziali ed

alle altre disposizioni pertinenti stabilite dalla direttiva 2014/53/UE.

#### ES

Por medio de la presente Axis Communications AB declara que el este producto cumple con los requisitos esenciales y cualesquiera otras disposiciones aplicables o exigibles de la Directiva 2014/53/UE.

#### FI

Axis Communications AB vakuuttaa täten että tämä tuote tyypinen laite on direktiivin 2014/53/UE oleellisten vaatimusten ja sitä koskevien direktiivin muiden ehtojen mukainen.

#### NL

Hierbij verklaart Axis Communications AB dat het toestel in overeenstemming is met de essentiële eisen en de andere relevante bepalingen van richtlijn 2014/53/UE.

#### SV

Härmed intygar Axis Communications AB att denna produkt står i överensstämmelse med de väsentliga egenskapskrav och övriga relevanta bestämmelser som framgår av direktiv 2014/53/UE.

#### DA

Undertegnede Axis Communications AB erklærer herved, at følgende udstyr overholder de væsentlige krav og øvrige relevante krav i direktiv 2014/53/UE.

#### PT

Axis Communications AB declara que este produto está conforme com os requisitos essenciais e outras disposições da Directiva 2014/53/UE.

#### EL

Με την παρούσα η Axis Communications AB δηλώνει ότι αυτό το προϊόν συμμορφώνεται προς τις ουσιαστικές απαιτήσεις και τις λοιπές σχετικές διατάξεις της οδηγίας 2014/53/EE.



This equipment can be used in the following countries:

AT, BE, BG, CH, CY, CZ, DE, DK, EE, EL, ES, FI, FR, HR, HU, IE, IS, IT, LI, LT, LU, LV, MT, NL, NO, PL, PT, RO, SE, SI, SK, TR, UK

Australia/New Zealand

This digital equipment fulfills the requirements of the Radio Communications Standard AS/NZS 4771.

#### Korea

해당무선설비는운용중전자파혼신가능성이있음으로인명안전과 관련된 서비스는할수없습니다

#### Japan

本製品は、特定無線設備の技術基準適合証明を受けています。

当該機器には電波法に基づく、技術基準適合証明等を受けた特定無線設備を装着している。

#### Safety

This product complies with IEC/EN/UL 62368-1, safety of audio/video and IT equipment for outdoor use.

The product shall be grounded either through a shielded network cable (STP) or other appropriate method.

The power supply used with this product shall have a rated output voltage within voltage range of 10–14 V DC, and a max current rating of 1.0 A.

The power supply used with this product shall fulfill one of the following requirements:

- Safety Extra Low Voltage (SELV) according to CEC/NEC Class 2 source of supply as defined in the Canadian Electrical Code, CSA C22.1 and National Electrical Code, ANSI/NFPA 70
- Class 1 electrical energy source (ES1) and Class 2 power source (PS2) rated output power limited to ≤100 W according to IEC/EN/UL 62368-1

When used with Power over Ethernet (PoE), the Power Sourcing Equipment (PSE) shall comply with IEEE 802.3af and Limited Power Source (LPS) according to annex Q of IEC/EN/UL 62368-1.

We recommend the use of Axis midspans or Axis PoE switches.

#### Disposal and recycling

When this product has reached the end of its useful life, dispose of it according to local laws and regulations. For information about your nearest designated collection point, contact your local authority responsible for waste disposal. In accordance

with local legislation, penalties may be applicable for incorrect disposal of this waste.

#### Europe



This symbol means that the product shall not be disposed of together with household or commercial waste. Directive 2012/19/EU on waste electrical and electronic equipment (WEEE) is applicable in the European Union member states. To prevent potential harm to human health and the environment, the product must be disposed of in an approved and environmentally safe recycling process. For information about your nearest designated collection point, contact your local authority responsible for waste disposal. Businesses should contact the product supplier for information about how to dispose of this product correctly.

This product complies with the requirements of Directive 2011/65/EU and 2015/863 on the restriction of the use of certain hazardous substances in electrical and electronic equipment (RoHS).

#### China



This product complies with the requirements of SJ/T 11364-2024, Marking for the restriction of hazardous substances in electrical and electronic products.

有毒有害物质或元素	
部件名称	电气实装部分
铅 (Pb)	X
汞 (Hg)	○
镉 (Cd)	○
六价铬 (Cr(VI))	○
多溴联苯 (PBB)	○

多溴二苯醚 (PBDE)	○
邻苯二甲酸二正丁酯 (DBP)	○
邻苯二甲酸二异丁酯 (DIBP)	○
邻苯二甲酸丁苄酯 (BBP)	○
邻苯二甲酸二(2-乙基)己酯 (DEHP)	○
<p>○ : 表示该有毒有害物质在该部件均质材料中的含量均在GB/T 26572标准规定的限量要求以下。</p> <p>X: 表示该有毒有害物质至少在该部件的某一均质材料中的含量超出GB/T 26572标准规定的限量要求。</p>	

#### Contact information

Axis Communications AB  
Gränden 1  
223 69 Lund  
Sweden

Tel: +46 46 272 18 00

[axis.com](http://axis.com)

#### Warranty information

For information about Axis' product warranty and thereto related information, go to [axis.com/warranty](http://axis.com/warranty).

#### Support

If you need technical assistance, contact your Axis reseller. If your questions can't be answered immediately, your reseller will forward your question through appropriate channels to ensure a quick response. At [axis.com/support](http://axis.com/support) you can:

- find answers to your questions in the FAQ portal
- chat with and report problems to Axis support by logging in to your private support area

## Cybersecurity

### Axis security notification service

Axis provides a notification service with information about vulnerability and other security related matters for Axis devices. To receive notifications, you can subscribe at [axis.com/security-notification-service](https://axis.com/security-notification-service).

### Vulnerability management

To minimize customers' risk of exposure, Axis, as a **Common Vulnerability and Exposures (CVE) numbering authority (CNA)**, follows industry standards to manage and respond to discovered vulnerabilities in our devices, software, and services. For more information about Axis vulnerability management policy, how to report vulnerabilities, already disclosed vulnerabilities, and corresponding security advisories, see [axis.com/vulnerability-management](https://axis.com/vulnerability-management).

### Secure operation of Axis devices

Axis devices with factory default settings are pre-configured with secure default protection mechanisms. We recommend using more security configuration when installing the device. To learn more about Axis' approach to cybersecurity, including best practices, resources, and guidelines for securing your devices, go to [axis.com/about-axis/cybersecurity](https://axis.com/about-axis/cybersecurity).

### Learn more!

Visit Axis learning center [axis.com/learning](https://axis.com/learning) for useful trainings, webinars, tutorials and guides.

# English

## Safety information

### Hazard levels

#### **⚠ DANGER**

Indicates a hazardous situation which, if not avoided, will result in death or serious injury.

#### **⚠ WARNING**

Indicates a hazardous situation which, if not avoided, could result in death or serious injury.

#### **⚠ CAUTION**

Indicates a hazardous situation which, if not avoided, could result in minor or moderate injury.

#### **NOTICE**

Indicates a situation which, if not avoided, could result in damage to property.

### Other message levels

#### **Important**

Indicates significant information which is essential for the product to function correctly.

#### **Note**

Indicates useful information which helps in getting the most out of the product.

## Safety instructions

### **NOTICE**

- The Axis product shall be used in compliance with local laws and regulations.
- This product is for professional use.
- Install this product at a safe distance from children.
- Store the Axis product in a dry and ventilated environment.
- Avoid exposing the Axis product to shocks or heavy pressure.
- Install the product using screws and plugs appropriate for the material (e.g. wood, metal, sheet rock, stone).
- Do not install the product on unstable poles, brackets, surfaces or walls.
- Use only applicable tools when installing the Axis product. Using excessive force with power tools could cause damage to the product.
- Use a soft cloth dampened with pure lukewarm water to clean the device.
- Don't use chemicals such as window cleaner or acetone to clean your device.
- Use only accessories that comply with the technical specification of your product. These can be provided by Axis or a third party. Axis recommends using Axis power source equipment compatible with your product.
- Use only spare parts provided by or recommended by Axis.
- Do not attempt to repair the product yourself. Contact Axis support or your Axis reseller for service matters.
- The power supply shall be plugged in to a socket outlet installed near the product and shall be easily accessible.

### Transportation

#### **NOTICE**

- When transporting the Axis product, use the original packaging or equivalent to prevent damage to the product.

## Battery

Lithium coin cell 3.0 V batteries contain 1,2-dimethoxyethane; ethylene glycol dimethyl ether (EGDME), CAS no. 110-71-4.

## Dome or front glass

### NOTICE

- Don't clean a dome or front glass that looks clean to the eye, and never polish the surface. Excessive cleaning can damage the surface.
- Avoid cleaning the dome or front glass in direct sunlight or at elevated temperatures, since this can cause stains.

# Français

## Informations sur la sécurité

### Niveaux de risques

#### DANGER

Indique une situation dangereuse qui, si elle n'est pas évitée, entraînera le décès ou des blessures graves.

#### AVERTISSEMENT

Indique une situation dangereuse qui, si elle n'est pas évitée, pourrait entraîner le décès ou des blessures graves.

#### ATTENTION

Indique une situation dangereuse qui, si elle n'est pas évitée, pourrait entraîner des blessures légères ou modérées.

#### AVIS

Indique une situation qui, si elle n'est pas évitée, pourrait endommager l'appareil.

### Autres niveaux de message

#### Important

Indique les informations importantes, nécessaires pour assurer le bon fonctionnement de l'appareil.

## Remarque

Indique les informations utiles qui permettront d'obtenir le fonctionnement optimal de l'appareil.

## Consignes de sécurité

### AVIS

- Le produit Axis doit être utilisé conformément aux lois et règlements locaux.
- Ce produit est destiné à un usage professionnel.
- Installez ce produit à une distance sûre des enfants.
- Conserver ce produit Axis dans un environnement sec et ventilé.
- Ne pas exposer ce produit Axis aux chocs ou aux fortes pressions.
- Installer le produit à l'aide de vis et de chevilles adaptées au matériau (bois, métal, placoplâtre, pierre).
- Ne pas installer ce produit sur des poteaux, supports, surfaces ou murs instables.
- Utiliser uniquement des outils recommandés pour l'installation de l'appareil Axis. L'application d'une force excessive sur l'appareil avec des outils puissants pourrait l'endommager.
- Pour nettoyer le dispositif, utilisez un chiffon doux humide à l'eau tiède pure.
- N'utilisez pas de produits chimiques tels que le nettoyant pour vitres ou l'acétone pour nettoyer votre dispositif.
- Utiliser uniquement des accessoires conformes aux caractéristiques techniques de votre produit. Ils peuvent être fournis par Axis ou un tiers. Axis recommande d'utiliser un équipement d'alimentation Axis compatible avec votre produit.
- Utiliser uniquement les pièces de rechange fournies ou recommandées par Axis.
- Ne pas essayer de réparer vous-même ce produit. Contacter l'assistance technique d'Axis ou votre revendeur Axis pour des problèmes liés à l'entretien.
- L'alimentation électrique doit être branchée à une prise de courant installée près de l'équipement et être facilement accessible.

## Transport

### AVIS

- Lors du transport du produit Axis, utilisez l'emballage d'origine ou un équivalent pour éviter d'endommager le produit.

## Batterie

Les piles boutons 3,0 V au lithium contiennent du 1,2-diméthoxyéthane, éthylène glycol diméthyl éther (EGDME), CAS n° 110-71-4.

## Dôme ou vitre avant

### AVIS

- Ne nettoyez pas un couvercle de dôme ou une vitre avant qui semble propre à l'œil nu et ne frottez jamais sa surface. Un nettoyage excessif peut l'endommager.
- Évitez de nettoyer le dôme ou la vitre avant en cas de lumière directe du soleil ou à des températures élevées, car cela peut entraîner des taches.

# Deutsch

## Sicherheitsinformationen

### Gefährdungsstufen

#### GEFAHR

Weist auf eine gefährliche Situation hin, welche, wenn sie nicht vermieden wird, zum Tod oder zu schweren Verletzungen führen wird.

#### WARNUNG

Weist auf eine gefährliche Situation hin, welche, wenn sie nicht vermieden wird, zum Tod oder zu schweren Verletzungen führen könnte.

#### VORSICHT

Weist auf eine gefährliche Situation hin, welche, wenn sie nicht vermieden wird, zu leichteren oder mäßig schweren Verletzungen führen könnte.

### HINWEIS

Weist auf eine Situation hin, welche, wenn sie nicht vermieden wird, zu Sachschäden führen könnte.

## Andere Meldeebenen

### Wichtig

Weist auf wichtige Informationen hin, die den richtigen Betrieb des Produkts gewährleisten.

### Hinweis

Weist auf nützliche Informationen hin, die die optimale Verwendung des Produkts unterstützen.

## Sicherheitsanweisungen

### HINWEIS

- Das Axis Produkt muss unter Beachtung der geltenden Gesetze und Bestimmungen betrieben werden.
- Dieses Produkt ist für den professionellen Gebrauch bestimmt.
- Installieren Sie dieses Produkt in sicherer Entfernung von Kindern.
- Lagern Sie das Axis Produkt in einer trockenen und belüfteten Umgebung.
- Das Axis Produkt weder Stößen noch starkem Druck aussetzen.
- Die Schrauben und Dübel müssen für das entsprechende Material (wie etwa Holz, Metall, Gipskartonplatten, Beton) geeignet sein.
- Installieren Sie das Produkt nicht an instabilen Masten, Halterungen, Oberflächen oder Wänden.
- Verwenden Sie bei der Installation des Axis Produkts ausschließlich passende Werkzeuge. Ein zu großer Kraftaufwand mit elektrischen Werkzeugen kann das Produkt beschädigen.
- Verwenden Sie zur Reinigung des Geräts ein weiches, mit lauwarmem reinen Wasser befeuchtetes Tuch.
- Verwenden Sie zur Reinigung Ihres Geräts keine chemischen Substanzen wie Fensterreiniger oder Aceton.
- Verwenden Sie nur Zubehör, das den technischen Vorgaben Ihres Produkts entspricht.

Dieses ist von Axis oder Drittanbietern erhältlich. Axis empfiehlt die mit Ihrem Produkt kompatible Stromversorgung von Axis.

- Verwenden Sie ausschließlich Ersatzteile die von Axis angeboten oder empfohlen werden.
- Versuchen Sie nicht, dieses Produkt selbsttätig zu reparieren. Wenden Sie sich bezüglich Reparatur und Wartung an den Axis Support oder Ihren Axis Händler.
- Das Netzteil sollte an eine Steckdose in der Nähe des Produkts angeschlossen werden und leicht zugänglich sein.

#### Transport

##### **HINWEIS**

- Bei Bedarf transportieren Sie das Axis Produkt in der Originalverpackung oder einer entsprechenden Verpackung, so dass Schäden vermieden werden.

#### Batterie

Lithium-Knopfzellen (3,0 V) enthalten 1,2-Dimethoxyethan; Ethylenglycoldimethylether (EGDME), CAS-Nr. 110-71-4.

#### Dome oder Frontscheibe

##### **HINWEIS**

- Säubern Sie die Dome-Abdeckung oder die Frontscheibe nicht, wenn diese sauber aussehen, und polieren Sie niemals die Oberfläche. Übermäßiges Reinigen kann die Oberfläche beschädigen.
- Vermeiden Sie die Reinigung von Dome oder Frontscheibe bei direktem Sonnenlicht oder bei erhöhten Temperaturen, da dies zu Flecken führen kann.

## Italiano

### Informazioni di sicurezza

#### Livelli di pericolo

##### **⚠ PERICOLO**

Indica una situazione pericolosa che, se non evitata, provoca morte o lesioni gravi.

##### **⚠ AVVISO**

Indica una situazione pericolosa che, se non evitata, potrebbe provocare la morte o lesioni gravi.

##### **⚠ ATTENZIONE**

Indica una situazione pericolosa che, se non evitata, potrebbe provocare lesioni medie o minori.

##### **AVVISO**

Indica una situazione che, se non evitata, potrebbe danneggiare la proprietà.

#### Altri livelli di messaggio

##### **Importante**

Indica informazioni importanti, essenziali per il corretto funzionamento del dispositivo.

##### **Nota**

Indica informazioni utili che aiutano a ottenere il massimo dal dispositivo.

## Istruzioni per la sicurezza

### AWISO

- Il dispositivo Axis deve essere utilizzato in conformità alle leggi e alle normative locali.
- Questo prodotto è destinato all'uso professionale.
- Installare il prodotto a una distanza di sicurezza dai bambini.
- Conservare il dispositivo Axis in un ambiente asciutto e ventilato.
- Evitare di esporre il dispositivo Axis a urti o pressioni eccessive.
- Installare il dispositivo usando le viti e i tasselli adatti al materiale (ad esempio legno, metallo, cartongesso, pietra).
- Non installare il dispositivo su supporti, superfici, pareti o pali instabili.
- Utilizzare solo strumenti applicabili quando si installa il prodotto Axis. Se si utilizza una forza eccessiva con strumenti non adatti è possibile causare danni al dispositivo.
- Usare un panno morbido inumidito con acqua pura tiepida per pulire il dispositivo.
- Non utilizzare sostanze chimiche come detersivi per vetri o acetone per pulire il dispositivo.
- Utilizzare solo accessori compatibili con le specifiche tecniche del dispositivo. Questi possono essere forniti da Axis o da terze parti. Axis consiglia l'uso dell'apparecchiatura di alimentazione Axis compatibile con il dispositivo.
- Utilizzare solo parti di ricambio fornite o consigliate da Axis.
- Non tentare di riparare il dispositivo da soli. Contattare l'assistenza o il rivenditore Axis per questioni relative alla manutenzione.
- L'alimentatore dovrebbe essere collegato a una presa di corrente vicina al dispositivo e facilmente accessibile.

## Trasporto

### AWISO

- Durante il trasporto del dispositivo Axis, utilizzare l'imballaggio originale o equivalente per evitare danni al dispositivo.

## Batteria

Le batterie a bottone al litio da 3 V contengono 1,2-dimetossietano; etere dimetilico di glicole etilenico (EGDME), CAS n. 110-71-4.

## Cupola o vetro frontale

### AWISO

- Non pulire la cupola o il vetro frontale quando allo sguardo sembra pulito e non lucidare mai la superficie. La pulizia eccessiva può danneggiare la superficie.
- Evitare la pulizia della cupola o del vetro frontale alla luce diretta del sole o a temperature elevate, poiché ciò può causare macchie.

## Español

## Información de seguridad

### Niveles de peligro

#### PELIGRO

Indica una situación peligrosa que, si no se evita, provocará lesiones graves o la muerte.

#### ADVERTENCIA

Indica una situación peligrosa que, si no se evita, puede provocar lesiones graves o la muerte.

#### PRECAUCIÓN

Indica una situación peligrosa que, si no se evita, puede provocar lesiones moderadas o leves.

#### AVISO

Indica una situación peligrosa que, si no se evita, puede provocar daños materiales.

## Otros niveles de mensaje

### Importante

Indica información importante que es fundamental para que el producto funcione correctamente.

### Nota

Indica información útil que ayuda a aprovechar el producto al máximo.

## Instrucciones de seguridad

### AVISO

- Este producto de Axis debe utilizarse de acuerdo con las leyes y normativas locales.
- Este producto es para uso profesional.
- Instale este producto a una distancia segura de los niños.
- Almacene el producto de Axis en un entorno seco y ventilado.
- Evite exponer el producto Axis a golpes o presiones excesivas.
- Instale el producto utilizando los tornillos y tacos adecuados para el material (por ejemplo, madera, metal, placas de yeso, piedra, etc.).
- No instale el producto en postes, soportes, superficies o paredes inestables.
- Use solo las herramientas adecuadas al instalar el producto Axis. La aplicación de una fuerza excesiva con herramientas eléctricas puede provocar daños en el producto.
- Utilice un paño suave humedecido con agua pura y tibia para limpiar el dispositivo.
- No utilice productos químicos como un limpiacristales o acetona para limpiar el dispositivo.
- Utilice solo accesorios que cumplan con las especificaciones técnicas de su producto. Puede obtenerlos de Axis o de un tercero. Axis recomienda utilizar un equipo de suministro de alimentación de Axis compatible con su producto.
- Utilice solo piezas de recambio suministradas o recomendadas por Axis.
- No intente reparar el producto usted mismo. Contacte con el servicio de asistencia de Axis o

a su distribuidor de Axis para cualquier tema relacionado con el mantenimiento.

- La fuente de alimentación se enchufará a una toma de conector instalada cerca del producto y a la que se podrá acceder fácilmente.

## Transporte

### AVISO

- Cuando transporte el producto de Axis, utilice el embalaje original o un equivalente para evitar daños en el producto.

## Batería

Las pilas de botón de litio de 3,0 V contienen 1,2-dimetoxietano; éter dimetilico de etilenglicol (EGDME), n.º CAS 110-71-4.

## Domo o cristal delantero

### AVISO

- No limpie un domo ni el cristal delantero si parecen estar limpios a simple vista y no pule nunca la superficie. Una limpieza excesiva puede dañar la superficie.
- Evite limpiar el domo o el cristal delantero en contacto directo con la luz o a temperaturas elevadas, ya que puede provocar manchas.

## 日本語

## 安全情報

### 危険レベル

#### 危険

回避しない場合、死亡または重傷につながる危険な状態を示します。

#### 警告

回避しない場合、死亡または重傷につながるおそれのある危険な状態を示します。

#### 注意

回避しない場合、軽傷または中程度の怪我につながるおそれのある危険な状態を示します。

## 注意

回避しない場合、器物の破損につながるおそれのある状態を示します。

## その他のメッセージレベル

### 重要

製品を正しく機能させるために不可欠な重要情報を示します。

### 注

製品を最大限に活用するために役立つ有用な情報を示します。

## 安全に関する指示

### 注意

- 本製品は、お使いになる地域の法律や規制に準拠して使用してください。
- 本製品は業務用です。
- 本製品はおお客様の手の届かない場所に設置してください。
- 本製品は乾燥した換気のよい環境に保管してください。
- 本製品に衝撃または強い圧力を加えないでください。
- 材質(木材、金属、シートロック、石材など)に適したネジとプラグを使用して本製品を設置してください。
- 本製品を不安定なポール、ブラケット、表面、または壁に設置しないでください。
- 本製品を設置する際には、適切な工具のみを使用してください。電動工具を使用して過剰な力をかけると、製品が損傷することがあります。
- 装置のクリーニングには、ぬるま湯で湿らせた柔らかい布を使用してください。
- 窓ガラス用洗剤やアセトンなどの化学薬品を使用して装置をクリーニングしないでください。
- 製品の技術仕様に準拠したアクセサリーのみを使用してください。これらのアクセサリーは、Axisまたはサードパーティから入手できます。Axisは、ご使用の製品と

互換性のあるAxis給電ネットワークスイッチの使用を推奨します。

- Axisが提供または推奨する交換部品のみを使用してください。
- 製品を自分で修理しないでください。修理については、Axisサポートまたは販売代理店にお問い合わせください。
- 電源は、製品の近くで簡単に手の届く場所にあるコンセントに接続してください。

## 輸送

### 注意

- 本製品を運搬する際は、製品が損傷しないよう、元の梱包か同等の梱包を使用してください。

## バッテリー

リチウムコイン型3.0V電池は、1,2-ジメトキシエタン(エチレンジメチルエーテル(EGDME)、CAS番号110-71-4)を含有しています。

## ドームやフロントガラス

### 注意

- 肉眼で見て汚れがない場合は、ドームやフロントガラスをクリーニングしないでください。また、絶対に表面を磨かないでください。過度なクリーニングは表面を傷つける可能性があります。
- 直射日光の当たる場所や高温の場所でドームやフロントガラスをクリーニングすると、染みの原因となるため避けてください。

## Português

## Informações sobre segurança

### Níveis de perigo

#### PERIGO

Indica uma situação perigosa que, se não evitada, irá resultar em morte ou lesões graves.

### **⚠ AVISO**

Indica uma situação perigosa que, se não evitada, poderá resultar em morte ou lesões graves.

### **⚠ CUIDADO**

Indica uma situação perigosa que, se não evitada, poderá resultar em lesões leves ou moderadas.

### **OBSERVAÇÃO**

Indica uma situação perigosa que, se não evitada, poderá resultar em danos à propriedade.

## Outros níveis de mensagens

### **Importante**

Indica informações significativas que são essenciais para o produto funcionar corretamente.

### **Observação**

Indica informações úteis que ajudam a obter o máximo do produto.

## Instruções de segurança

### **OBSERVAÇÃO**

- O produto Axis deve ser usado em conformidade com as leis e regulamentações locais.
- Este produto destina-se ao uso profissional.
- Instale este produto a uma distância segura de crianças.
- Armazene o produto Axis em um ambiente seco e ventilado.
- Evite expor o produto Axis a impactos ou pressão elevada.
- Instale o produto usando parafusos e buchas adequados para o material (por exemplo, madeira, metal, alvenaria, pedra).
- Não instale o produto em suportes, mastros, superfícies ou paredes instáveis.
- Use apenas as ferramentas recomendadas ao instalar o produto Axis. O uso de força excessiva

com ferramentas elétricas poderia danificar o produto.

- Use um pano macio umedecido com água morna para limpar o dispositivo.
- Não use produtos químicos como limpa-vidros ou acetona para limpar o dispositivo.
- Utilize apenas acessórios que atendam às especificações técnicas do produto. Esses poderão ser fornecidos pela Axis ou por terceiros. A Axis recomenda usar equipamento de fonte de alimentação Axis compatível com seu produto.
- Utilize apenas peças sobressalentes fornecidas ou recomendadas pela Axis.
- Não tente reparar o produto por conta própria. Entre em contato com o suporte ou seu revendedor Axis para quaisquer questões relacionadas a serviços.
- A fonte de alimentação deve ser conectada em uma tomada elétrica instalada próxima ao produto e deverá poder ser acessada com facilidade.

## Transporte

### **OBSERVAÇÃO**

- Ao transportar o produto Axis, use a embalagem original ou equivalente para evitar danos ao produto.

## Bateria

As baterias tipo célula de íons de lítio de 3,0 V contêm 1,2-dimetoxietano; etileno glicol éter dimetilico (EGDME), nº CAS 110-71-4.

## Dome ou vidro frontal

### **OBSERVAÇÃO**

- Não limpe domes ou vidros frontais que pareçam visualmente limpos, e jamais faça o polimento da superfície. Limpar de forma excessiva pode danificar a superfície.
- Evite limpar a dome ou o vidro frontal sob luz solar direta ou em temperaturas elevadas, pois isso poderá causar manchas.

# РУССКИЙ

## Сведения по безопасности

### Уровни опасности

#### **⚠ ОПАСНО**

Опасная ситуация, которая, если ее не устранить, приведет к смерти или опасным травмам.

#### **⚠ ВНИМАНИЕ!**

Опасная ситуация, которая, если ее не устранить, может привести к смерти или опасным травмам.

#### **⚠ ОСТОРОЖНО**

Опасная ситуация, которая, если ее не устранить, может привести к травмам незначительной или средней тяжести.

#### **ПРИМЕЧАНИЕ.**

Опасная ситуация, которая, если ее не устранить, может вызвать повреждение имущества.

### Прочие уведомления

#### **Внимание**

Означает существенную информацию, которая важна для правильной работы изделия.

#### **Примечание**

Означает полезную информацию, которая помогает использовать все возможности изделия.

### Инструкции в экстренных ситуациях

#### **ПРИМЕЧАНИЕ.**

- Это изделие Axis следует использовать в

соответствии с местными законами и нормативами.

- Это изделие предназначено для профессионального использования.
- Устанавливайте изделие на безопасном расстоянии от детей.
- Устройство Axis должно храниться в сухом, хорошо проветриваемом помещении.
- Не допускайте ударов или сильного давления на устройство Axis.
- Смонтируйте устройство с помощью винтов и дюбелей, подходящих для данного материала (дерево, металл, гипсоцементная плита, камень).
- Не монтируйте устройство на неустойчивых столбах, кронштейнах, поверхностях или стенах.
- При установке устройства Axis используйте только предназначенные для этого инструменты. Приложение чрезмерных усилий к инструментам может привести к повреждению устройства.
- Для очистки устройства используйте мягкую ткань, смоченную в чистой умеренно теплой воде.
- Не используйте для очистки устройства средство для мытья окон, ацетон и другие подобные химические вещества.
- Используйте только принадлежности, которые соответствуют техническим характеристикам данного устройства. Они могут поставляться компанией Axis или сторонним производителем. Компания Axis рекомендует использовать блоки питания Axis, совместимые с устройством.
- Используйте только запасные части, поставляемые или рекомендованные компанией Axis.
- Не пытайтесь отремонтировать устройство самостоятельно. По вопросам обслуживания обращайтесь в службу поддержки Axis или к своему реселлеру Axis.
- Блок питания следует включать в розетку, которая должна быть легко доступной и располагаться недалеко от изделия.

## Transportierovka

### PRIMEЧАНИЕ.

- При транспортировке устройства Axis используйте оригинальную упаковку или ее эквивалент во избежание повреждения изделия.

## Батарея

Плоские литиевые батареи (3,0 В) содержат 1,2-диметоксизтан – диметилвый эфир этиленгликоля (EGDME), CAS № 110-71-4.

## Купол или переднее стекло

### PRIMEЧАНИЕ.

- Не протирайте купол или переднее стекло, если на них не заметны загрязнения, и ни при каких обстоятельствах не полируйте их поверхность. Излишняя очистка может привести к повреждению поверхности.
- Не чистите купол или переднее стекло под прямыми солнечными лучами или при повышенной температуре, так как это может привести к образованию пятен.

## 한국어

## 안전 정보

### 위험 레벨

#### ▲ 위험

피하지 못한 경우 사망이나 심각한 부상이 발생하는 위험한 상황을 나타냅니다.

#### ▲ 경고

피하지 못한 경우 사망이나 심각한 부상이 발생할 수 있는 위험한 상황을 나타냅니다.

#### ▲ 주의

피하지 못한 경우 경미하거나 심하지 않은 부상이 발생할 수 있는 위험한 상황을 나타냅니다.

## 통지

피하지 못한 경우 재산상 손해가 발생할 수 있는 상황을 나타냅니다.

## 기타 메시지 레벨

### 중요 사항

제품이 올바르게 작동하는 데 필수적인 중요 정보를 나타냅니다.

### 비고

제품을 최대한으로 활용하는 데 도움이 되는 유용한 정보를 나타냅니다.

## 안전 지침

### 통지

- Axis 제품은 해당 지역 법률 및 규정을 준수하여 사용해야 합니다.
- 이 제품은 전문가용입니다.
- 이 제품은 어린이로부터 안전한 거리에 설치하십시오.
- Axis 제품은 건조하고 환기가 잘 되는 곳에 보관하십시오.
- Axis 제품에 충격이나 강한 압력을 가하지 마십시오.
- 재질(예: 나무, 금속, 석고 보드, 돌)에 맞는 나사와 플리그를 사용하여 제품을 설치하십시오.
- 불안정한 폴, 브래킷, 표면 또는 벽면에 제품을 설치하지 마십시오.
- Axis 제품을 설치할 때에는 적절한 도구만 사용하십시오. 전동 공구로 과도한 힘을 사용하면 제품에 손상을 줄 수 있습니다.
- 미지근한 물에 적신 부드러운 천으로 장치를 세척합니다.
- 창문 세정제나 아세톤과 같은 화학 물질을 사용하여 장치를 세척하지 마십시오.
- 제품의 기술적 사양을 준수하는 액세서리만 사용하십시오. 이러한 액세서리는 Axis 또는 제3자가 제공할 수 있습니다. Axis는

귀하의 제품과 호환되는 Axis 전원 장비 사용을 권장합니다.

- Axis가 공급하거나 추천하는 예비 부품만 사용하십시오.
- 제품을 직접 수리하려고 하지 마십시오. 서비스 문제에 대해 Axis 지원 부서 또는 Axis 리셀러에 문의하십시오.
- 전원 공급 장치는 제품 근처에 설치된 소켓 콘센트에 꽂아야 하며 쉽게 접근할 수 있어야 합니다.

## 운반

### 통지

- Axis 제품을 운반할 때는 원래 포장이나 이에 준하는 포장을 사용해 제품이 손상되지 않도록 하십시오.

## 배터리

리튬 코인 셀 3.0V 배터리는 1,2-디메톡시에탄, EGDME(ethylene glycol dimethyl ether), CAS no. 110-71-4를 포함하고 있습니다.

## 돔 또는 전면 유리

### 통지

- 눈으로 보기에 깨끗한 돔이나 전면 유리는 닦지 말고, 표면에 광을 내지 마십시오. 과도한 청소는 표면에 손상을 줄 수 있습니다.
- 직사광선이나 높은 온도에서 돔이나 전면 유리를 닦으면 얼룩이 생길 수 있으므로 주의해서 피해야 합니다.

# 中文

## 安全信息

### 危险等级

#### ⚠ 危险

表示如果不避免则会导致死亡或严重伤害的危险情况。

#### ⚠ 警告

表示如果不避免则可能导致死亡或严重伤害的危险情况。

#### ⚠ 警告

表示如果不避免则可能导致轻微或中度伤害的危险情况。

#### 注意

表示如果不避免则可能导致财产损失的情况。

### 其他消息等级

#### 重要

表示产品正常工作所必需的重要信息。

#### 注意

表示有助于充分利用产品的有用信息。

## 安全说明

### 注意

- 使用安讯士产品时应遵守当地法律和法规。
- 本产品供专业人士使用。
- 安装本产品时，请与儿童保持安全距离。
- 在干燥通风的环境中存放安讯士产品。
- 避免将安讯士产品暴露在冲击或重压下。
- 使用适用于该材质（如木质、金属、石膏板、石头）的螺丝和塞子安装产品。
- 请勿将本产品安装在不稳定的立杆、支架、表面或墙壁上。
- 安装安讯士产品时，仅使用适用的工具。使用电动工具过度施力可能导致产品损坏。
- 使用蘸有温水的软布清洁设备。
- 请勿使用窗户清洁剂或丙酮等化学品来清洁设备。
- 仅使用符合产品技术规格的附件。这些附件可由安讯士或第三方提供。安讯士推荐使用与产品兼容的安讯士电源设备。
- 仅使用安讯士提供或推荐的备件。
- 请勿尝试自行维修产品。有关服务事项，请联系安讯士支持部门或安讯士经销商。
- 电源应插入安装在产品附近的插座上并易于触及。

## 运输

### 注意

- 安讯士产品运输途中，应使用其原包装或等效包装，以防对产品造成损坏。

## 电池

3.0 V 纽扣锂电池内含 1,2-二甲氧基乙烷；乙二醇二甲醚 (EGDME)，CAS 编号为 110-71-4。

## 球型罩或前玻璃

### 注意

- 请勿清洁看起来干净的球型罩或前玻璃，也不要对表面进行抛光。过度清洁会损坏表面。
- 避免在阳光直射或高温下清洁球型罩或前玻璃，因为这可能会导致污渍。

## 繁體中文

## 安全資訊

### 危險等級

#### ⚠ 危險

表示如果不避免，此危險情況會導致死亡或嚴重傷害。

#### ⚠ 警告

表示如果不避免，此危險情況可能導致死亡或嚴重傷害。

#### ⚠ 小心

表示如果不避免，此危險情況可能導致輕度或中度傷害。

### 注意

表示如果不避免，此情況可能導致財產損壞。

### 其他訊息等級

#### 重要

表示是產品正常運作所不可缺少的重要資訊。

#### 附註

表示是能充分發揮產品功能的實用資訊。

## 安全指示

### 注意

- Axis 產品的使用應符合當地法規。
- 本產品可用於專業用途。
- 將本產品安裝在遠離兒童之處，並保持適當距離以策安全。
- 請將安訊士產品存放在乾燥且通風良好的環境中。
- 避免讓 Axis 產品受到衝擊或重壓。
- 使用適用於材質的螺絲和插塞 (如木頭、金屬、石片、石材) 安裝產品。
- 請勿將產品安裝在不穩定的圓柱、支架、表面或牆壁上。
- 安裝 Axis 產品時，僅可使用適合的工具。使用電動工具時，過度施力可能會造成產品損壞。
- 使用沾有純淨溫水的軟布清潔設備。
- 請勿使用窗戶清潔劑或丙酮等化學物質來清潔設備。
- 所有配件必須符合產品的技術規格。可由 Axis 或第三方供應商提供。Axis 建議使用相容於產品的 Axis 電源設備。
- 只使用 Axis 提供或推薦的備用零件。
- 請勿嘗試自行修理產品。請向 Axis 技術支援人員或 Axis 經銷商洽詢維修事宜。
- 電源供應器應該連接到安裝在產品附近的插座，方便拆裝。

## 運輸

### 注意

- 當運送安訊士產品時，請使用原包裝或有相同保護效果的包裝，以防止產品損壞。

## 電池

鐘離子 3.0 V 鈕扣電池內含二甲基溶纖劑 (1,2-dimethoxyethane)；乙二醇 (ethylene glycol) 二甲醚 (dimethyl ether) (EGDME)，CAS 編號 110-71-4。

## 球形罩或前玻璃

### 注意

- 請勿清潔外表看起來乾淨的球形罩，且切勿拋光表面。過度清潔會使表面損壞。
- 避免在陽光直射或高溫下清潔球形罩或前玻璃，因為這樣會造成污漬。

# Bahasa Indonesia

## Informasi keselamatan

### Tingkat bahaya

#### **⚠ BAHAYA**

Menunjukkan situasi berbahaya yang jika tidak dihindari akan menyebabkan kematian atau cedera parah.

#### **⚠ PERINGATAN**

Menunjukkan situasi berbahaya yang jika tidak dihindari dapat mengakibatkan kematian atau cedera parah.

#### **⚠ PERHATIAN**

Menunjukkan situasi berbahaya yang jika tidak dihindari dapat menyebabkan cedera ringan atau sedang.

#### **PEMBERITAHUAN**

Menunjukkan situasi yang jika tidak dihindari dapat menyebabkan kerusakan properti.

### Tingkat status pesan lainnya

#### **Penting**

Menunjukkan informasi utama yang sangat penting agar produk dapat berfungsi normal.

#### **Catatan**

Menunjukkan informasi berguna yang membantu mengoptimalkan fungsi produk.

## Petunjuk keselamatan

### **PEMBERITAHUAN**

- Produk Axis harus digunakan sesuai dengan hukum dan peraturan setempat.
- Produk ini khusus digunakan oleh para profesional.
- Pasang produk ini di lokasi yang aman dari jangkauan anak-anak.
- Simpan produk Axis di lingkungan yang kering dan berventilasi.
- Pastikan produk Axis tidak terkena guncangan atau tekanan berat.
- Pasang produk menggunakan sekrup dan fischer yang sesuai dengan material (misalnya kayu, logam, sheet rock, dan batu).
- Jangan memasang produk pada tiang, braket, permukaan, atau dinding yang tidak stabil.
- Hanya gunakan alat yang sesuai ketika memasang produk Axis. Penggunaan perkakas listrik (power tool) dengan gaya berlebih dapat menyebabkan kerusakan pada produk.
- Gunakan kain lembut yang dibasahi dengan air hangat untuk membersihkan perangkat.
- Jangan gunakan bahan kimia seperti pembersih jendela, atau aseton untuk membersihkan perangkat Anda.
- Hanya gunakan aksesoris yang sesuai dengan spesifikasi teknis produk Anda. Aksesoris dapat disediakan oleh Axis atau pihak ketiga. Axis menyarankan penggunaan peralatan sumber daya Axis yang kompatibel dengan produk Anda.
- Hanya gunakan suku cadang yang disediakan atau disarankan oleh Axis.
- Jangan mencoba untuk memperbaiki produk sendiri. Hubungi staf dukungan Axis atau Axis reseller untuk hal-hal terkait servis.
- Suplai daya harus dipasang pada stopkontak yang terpasang di dekat produk dan mudah diakses.

### Pengangkutan

#### **PEMBERITAHUAN**

- Ketika mengangkat produk Axis, gunakan kemasan asli atau setara untuk mencegah kerusakan pada produk.

## Baterai

Baterai litium coin cell 3,0 V mengandung 1,2-dimetoksietana; etilen glikol dimetil ether (EGDME), CAS no. 110-71-4.

## Dome atau kaca depan

### PEMBERITAHUAN

- Jangan membersihkan dome atau kaca depan yang terlihat bersih dan dilarang keras memoles permukaannya. Pembersihan yang berlebihan dapat merusak permukaan dome.
- Dilarang membersihkan dome atau kaca depan di bawah sinar matahari langsung atau pada suhu tinggi karena tindakan ini dapat menimbulkan noda.

## Türk

### Güvenlik bilgileri

#### Tehlike seviyeleri

#### ⚠ TEHLİKE

Önlenmediği takdirde ölüme veya ciddi yaralanmaya yol açacak tehlikeli bir durumu belirtir.

#### ⚠ UYARI

Önlenmediği takdirde ölüme veya ciddi yaralanmaya yol açabilecek tehlikeli bir durumu belirtir.

#### ⚠ DİKKAT

Önlenmediği takdirde küçük veya orta derecede yaralanmaya yol açabilecek tehlikeli bir durumu belirtir.

#### İKAZ

Önlenmediği takdirde mülk hasarına yol açabilecek bir durumu belirtir.

#### Diğer mesaj seviyeleri

#### Önemli

Ürünün doğru şekilde çalışması için gerekli olan önemli bilgileri belirtir.

## Not

Üründen en iyi şekilde yararlanmanız yardımcı olacak faydalı bilgileri belirtir.

### Güvenlik talimatları

#### İKAZ

- Axis ürünü, yerel yasa ve yönetmeliklere uygun şekilde kullanılmalıdır.
- Bu ürün profesyonel kullanım için tasarlanmıştır.
- Bu ürünün kurulumunu çocuklardan güvenli bir mesafede gerçekleştirin.
- Axis ürünü kuru ve havalandırılmış bir ortamda saklayın.
- Axis ürünü darbelere veya aşırı basınca maruz bırakmayın.
- Ürünün montajını, malzemeye (örneğin ahşap, metal, alçıpan, taş) uygun vida ve dübelleri kullanarak gerçekleştirin.
- Ürünü dengelessiz direklere, braketlere, yüzeylere veya duvarlara monte etmeyin.
- Axis ürünü yalnızca uygun aletleri kullanarak monte edin. Elektrikli aletler ile aşırı güç uygulamak ürüne zarar verebilir.
- Cihazı temizlemek için saf ılık su ile nemlendirilmiş yumuşak bir bez kullanın.
- Cihazınızı temizlerken cam temizleyici veya aseton gibi kimyasal maddeler kullanmayın.
- Yalnızca ürününüzün teknik özelliklerine uygun aksesuarları kullanın. Bunlar Axis veya üçüncü bir tarafta sağlanabilir. Axis, ürününüz ile uyumlu Axis güç kaynağı ekipmanlarının kullanılmasını önerir.
- Yalnızca Axis tarafından sağlanan veya önerilen yedek parçaları kullanın.
- Ürünü kendiniz tamir etmeye çalışmayın. Servis ile ilgili konular için Axis destek birimine veya Axis bayinize başvurun.
- Güç kaynağı, ürünün yakınında bulunan ve kolayca erişilebilir bir prize takılmalıdır.

#### Taşımacılık

#### İKAZ

- Axis ürününün taşınması sırasında ürünün hasar görmesini önlemek için orijinal ambalajını veya muadilini kullanın.

## Pil

Lityum düğme hücreli 3.0 V piller 1,2-dimetoksietan; etilen glikol dimetil eter (EGDME) içerir, CAS no. 110-71-4.

## Kubbe veya ön cam

### **İKAZ**

- Görsel açıdan temiz görünen bir kubbeyi veya ön camı temizlemeyin ve yüzeyini asla parlatmayın. Aşırı temizlik, yüzeye zarar verebilir.
- Lekelere neden olabileceğinden, kubbeyi veya ön camı doğrudan güneş ışığına veya yüksek sıcaklıklara maruz bırakarak temizlemekten kaçının.



AXIS A4610

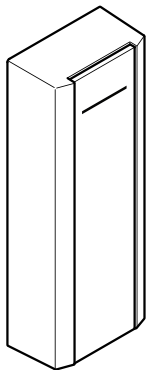

**1x**

AXIS A4612

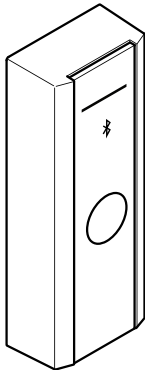

**1x**

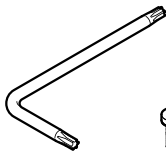

**1x**



**1x**



**2x**



**2x**



**2x**

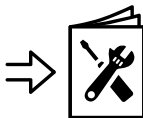
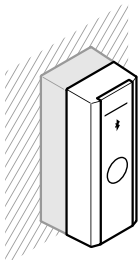
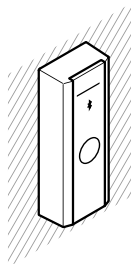

AXIS TA4601  
Installation guide

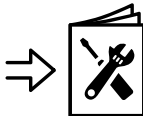
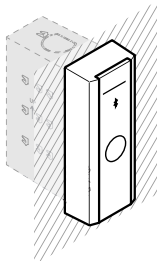

AXIS TA4602  
Installation guide

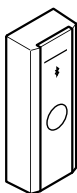

+

-

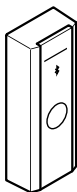
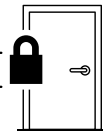

+

-

2N Security Relay

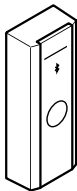
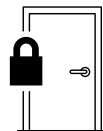

External DC

— NC —

— COM —

— NO —

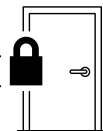



1:1

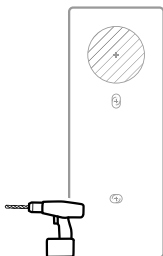

Drill template

# 1.1

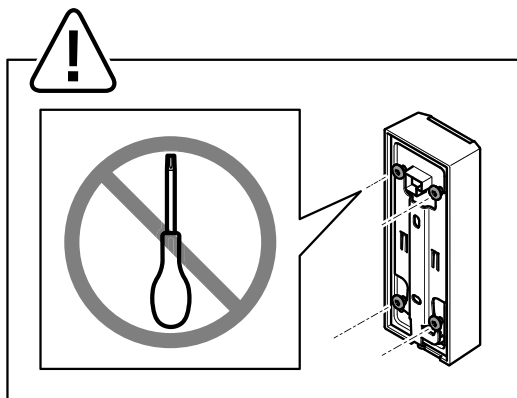
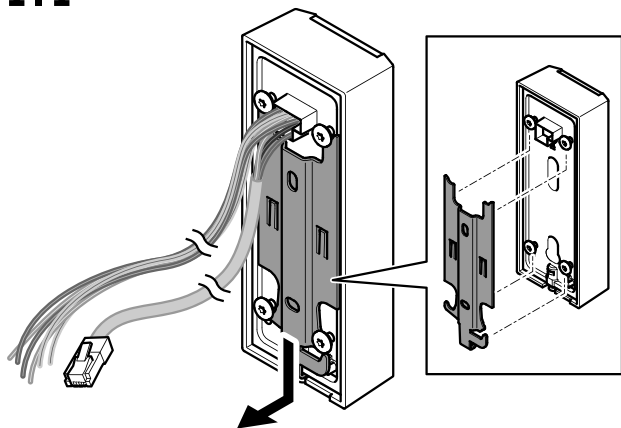

## 1.2

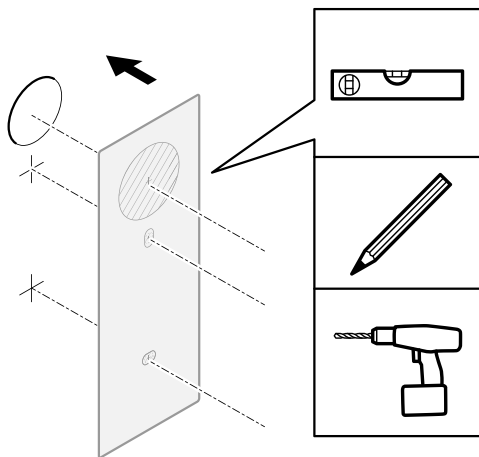

## 1.3

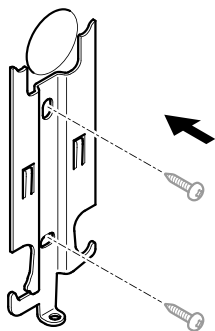

1.4

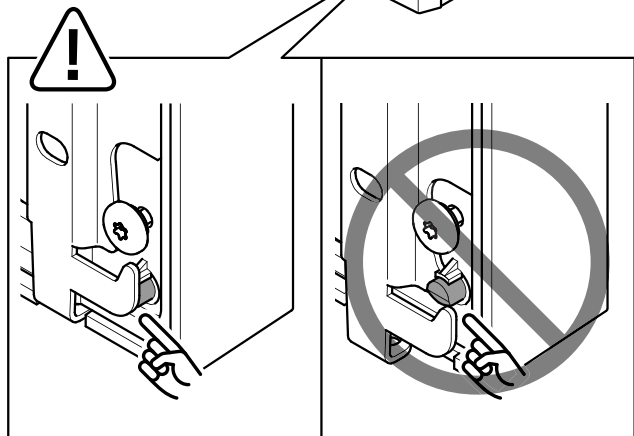
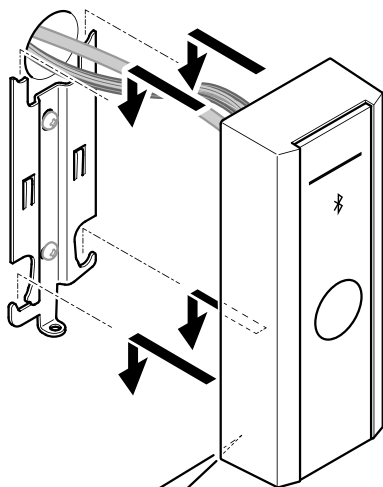

# 1.5

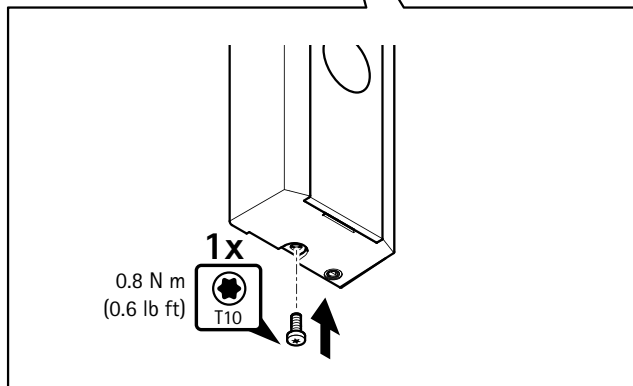
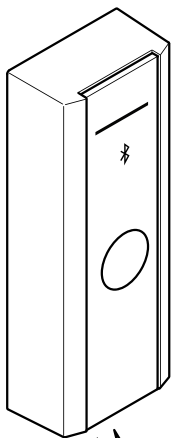

# 1.6

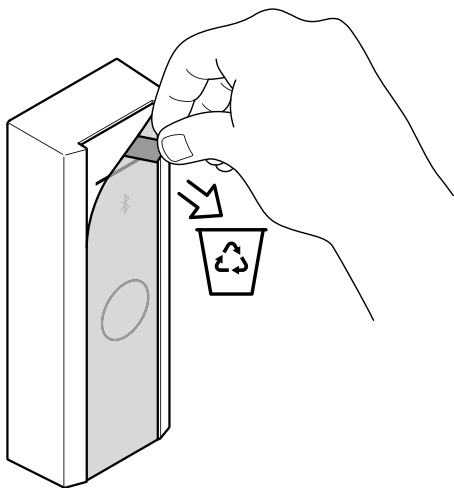

# 1.7

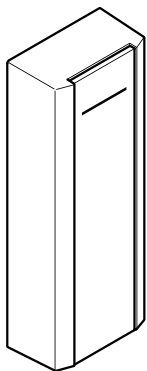

AXIS A4610

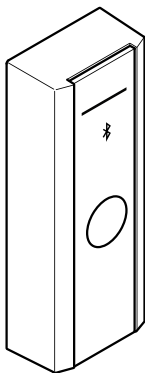

AXIS A4612



[help.axis.com](http://help.axis.com)

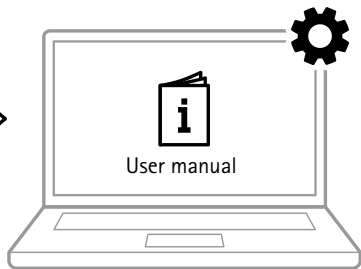



3570534

2026-06 (M5.2)

© 2024 – 2026 Axis Communications AB