

AXIS M4337-PLVE Panoramic Camera

6 MP outdoor-ready AI-powered with 360° view

This fisheye camera delivers 180°/360° coverage. Using the latest sensor technology, it offers 30% higher resolution than previous generations, reaching up to 2464×2464 pixels. Day/night functionality and built-in IR illumination ensure excellent images even in low light or complete darkness. It's AI-powered and comes with AXIS Object Analytics preinstalled. Plus, AI models are specifically trained for 360° fisheye view. It includes a range of camera-side dewarped views. Furthermore, this vandal- and impact-resistant camera includes Axis Edge Vault, a hardware-based cybersecurity platform that safeguards the device and offers FIPS 140-3 Level 3 certified secure key storage and operations.

- > [Latest sensor technology with 6 MP resolution](#)
- > [Camera-side dewarped views](#)
- > [Built-in IR with individual IR LEDs](#)
- > [Next-generation AI-powered analytics](#)
- > [Built-in cybersecurity with Axis Edge Vault](#)



AXIS M4337-PLVE Panoramic Camera

Camera

Image sensor

1/1.6" progressive scan RGB CMOS
Pixel size 2.0 µm

Lens

Focal length: 1.7 mm, F2.0
Horizontal field of view: 185°
Vertical field of view: 185°
Minimum focus distance: 0.1 m (0.3 ft)
Fixed iris, IR corrected

Day and night

Automatic IR-cut filter

Minimum illumination

Color: 0.08 lux at 50 IRE, F2.0
B/W: 0 lux at 50 IRE, F2.0
0 lux with IR illumination on

Shutter speed

1/111,000 s to 2 s with 50 Hz

System on chip (SoC)

Model

ARTPEC-9

Memory

4 GB RAM, 8 GB Flash

Compute capabilities

Deep learning processing unit (DLPU)

Video

Video compression

H.264 (MPEG-4 Part 10/AVC) Baseline, Main and High Profiles
H.265 (MPEG-H Part 2/HEVC) Main Profile
AV1
Motion JPEG

Resolution

2464x2464

Frame rate

6 MP 25/30 mode: 25/30 fps (50/60 Hz)
6 MP 50/60 mode (WDR off): 50/60 fps (50/60 Hz)
6 MP multi stream: 20/20 fps with 360 overview and 4 dewarped streams

Video streaming

Up to 20 unique and configurable video streams¹
Axis Zipstream technology in H.264, H.265 and AV1
Controllable frame rate and bandwidth
VBR/ABR/MBR H.264/H.265/AV1
Low latency mode
Video streaming indicator

Signal-to-noise ratio

>55 dB

WDR

Forensic WDR: Up to 120 dB depending on scene

Image settings

Saturation, contrast, brightness, sharpness, white balance, day/night threshold, local contrast, tone mapping, exposure mode, exposure zones, defog, compression, mirroring, dynamic text and image overlay, overlay widget, privacy masks, target aperture

Image processing

Axis Zipstream, Forensic WDR, Lightfinder, OptimizedIR

Pan/Tilt/Zoom

Digital PTZ, preset positions

Audio

Input and output through portcast technology accessories or edge-to-edge pairing. For more information, see *Optional accessories* and *Edge-to-edge*.

1. We recommend a maximum of 3 unique video streams per camera or channel, for optimized user experience, network bandwidth, and storage utilization. A unique video stream can be served to many video clients in the network using multicast or unicast transport method via built-in stream reuse functionality.

Network

Network protocols

IPv4, IPv6 USGv6, ICMPv4/ICMPv6, HTTP, HTTPS², HTTP/2, TLS², QoS Layer 3 DiffServ, FTP, SFTP, CIFS/SMB, SMTP, mDNS (Bonjour), UPnP[®], SNMP v1/v2c/v3 (MIB-II), DNS/DNSv6, DDNS, NTP, NTS, PTP, RTSP, RTP, SRTP/RTSPS, TCP, UDP, IGMPv1/v2/v3, RTCP, ICMP, DHCPv4/v6, ARP, SSH, LLDP, CDP, MQTT v3.1.1, Secure syslog (RFC 3164/5424, UDP/TCP/TLS), Link-Local address (ZeroConf)

System integration

Application Programming Interface

Open API for software integration, including VAPIX[®], metadata and AXIS Camera Application Platform (ACAP); specifications at axis.com/developer-community.

One-click cloud connection

ONVIF[®] Profile G, ONVIF[®] Profile M, ONVIF[®] Profile S, and ONVIF[®] Profile T, specifications at onvif.org

Video management systems

Compatible with AXIS Camera Station Edge, AXIS Camera Station Pro, AXIS Camera Station 5, and video management software from Axis' partners available at axis.com/vms.

Onscreen controls

Day/night shift
Defog
Wide dynamic range
Video streaming indicator
IR illumination
Privacy masks
Heater

Edge-to-edge

Speaker pairing
Siren and light pairing

Event conditions

Device status: above/below/within operating temperature, casing open, IP address blocked/removed, live stream active, network lost, new IP address, system ready

Edge storage: recording ongoing, storage disruption, storage health issues detected

Edge-to-edge: paired device unreachable

I/O: digital input is active, digital output is active, manual trigger, virtual input is active

MQTT: MQTT client connected, stateless

PTZ: PTZ control queue, PTZ malfunctioning, PTZ movement, PTZ preset position reached, PTZ ready

Scheduled and recurring: schedule

Video: average bitrate degradation, day-night mode, tampering

Event actions

Day-night mode

Defog

Guard tours

I/O: toggle I/O once, toggle I/O while the rule is active

Illumination: use lights, use lights while the rule is active

Images: FTP, SFTP, HTTP, HTTPS, network share and email

LEDs: flash status LED, flash status LED while the rule is active

MQTT: send MQTT publish message

Notification: HTTP, HTTPS, TCP and email

Overlay text

Preset positions

Recordings: record video, record video while the rule is active

Security: erase configuration

SNMP trap messages: send, send while the rule is active

Video clips: FTP, SFTP, HTTP, HTTPS, network share and email

WDR mode

Built-in installation aids

Digital roll

Analytics

Applications

Included

AXIS Object Analytics, AXIS Image Health Analytics, AXIS Scene Metadata, AXIS Video Motion Detection Support for AXIS Camera Application Platform enabling installation of third-party applications, see axis.com/acap

2. This product includes software developed by the OpenSSL Project for use in the OpenSSL Toolkit. (openssl.org), and cryptographic software written by Eric Young (eay@cryptsoft.com).

AXIS Object Analytics

Object classes: humans, vehicles (types: cars, buses, trucks, bikes, other)

Scenarios: line crossing, object in area, crossline counting, occupancy in area, tailgating detection, motion in area, motion line crossing

Up to 10 scenarios

Other features: triggered objects visualized with trajectories, color-coded bounding boxes and tables

Polygon include/exclude areas

Perspective configuration

ONVIF Motion Alarm event

AXIS Image Health Analytics

Detection settings:

Tampering: blocked image, redirected image

Image degradation: blurred image, underexposed image

Other features: sensitivity, validation period

AXIS Scene Metadata

Object classes: humans, faces, vehicles (types: cars, buses, trucks, bikes), license plates

Object attributes: vehicle color, upper/lower clothing color, bag, confidence, position

Approvals

Product markings

UL/cUL, CE, KC, VCCI, RCM

Supply chain

TAA compliant

EMC

CISPR 35, CISPR 32 Class A, EN 55035, EN 55032 Class A, EN 50121-4, EN 61000-6-1, EN 61000-6-2

Australia/New Zealand: RCM AS/NZS CISPR 32 Class A

Canada: ICES(A)/NMB(A)

Japan: VCCI Class A

Korea: KS C 9835, KS C 9832 Class A

USA: FCC Part 15 Subpart B Class A

Taiwan: CNS 15936

Railway: IEC 62236-4

Safety

CAN/CSA C22.2 No. 62368-1 ed. 3, IEC/EN/UL 62368-1 ed. 3, IEC/EN 62471 risk group exempt

Environment

IEC 60068-2-1, IEC 60068-2-2, IEC 60068-2-6, IEC 60068-2-14, IEC 60068-2-27, IEC 60068-2-78, IEC/EN 60529 IP66, IEC/EN 62262 IK10, ISO 21207 (Method B), NEMA 250 Type 4X

Network

NIST SP500-267

Cybersecurity

ETSI EN 303 645, BSI IT Security Label, FIPS 140

Cybersecurity

Edge security

Software: Signed OS, brute force delay protection, digest authentication and OAuth 2.0 RFC6749 Client Credential Flow/OpenID Authorization Code Flow for centralized ADFS account management, password protection, Axis Cryptographic Module (FIPS 140-2 level 1)

Hardware: Axis Edge Vault cybersecurity platform
Secure keystore: secure element (CC EAL 6+, FIPS 140-3 Level 3), system-on-chip security (TEE)
Axis device ID, signed video, secure boot, encrypted filesystem (AES-XTS-Plain64 256bit)

Network security

IEEE 802.1X (EAP-TLS, PEAP-MSCHAPv2)³, IEEE 802.1AE (MACsec PSK/EAP-TLS), IEEE 802.1AR, HTTPS/HSTS³, TLS v1.2/v1.3³, Network Time Security (NTS), X.509 Certificate PKI, host-based firewall

Documentation

AXIS OS Hardening Guide

Axis Vulnerability Management Policy

Axis Security Development Model

AXIS OS Software Bill of Material (SBOM)

To download documents, go to axis.com/support/cybersecurity/resources

To read more about Axis cybersecurity support, go to axis.com/cybersecurity

General

Casing

IP66-, NEMA 4X- and IK10-rated
Polycarbonate hard-coated dome
Aluminum
Color: white NCS S 1002-B
Repaintable skin cover accessory

3. This product includes software developed by the OpenSSL Project for use in the OpenSSL Toolkit. (openssl.org), and cryptographic software written by Eric Young (ey@cryptsoft.com).

Mounting

Mounting bracket with junction box holes (double-gang, single-gang, and 4" octagon)
1/4"-20 UNC tripod screw thread

Power

Power over Ethernet (PoE) IEEE 802.3at Type 2 Class 4, max 16.7 W, typical (heater off, IR off) 7.1 W
Features: dynamic power mode, power meter

Environmental sensors

Environmental sensors through portcast technology accessories. For more information, see *Optional accessories*.

I/O functionality

1 digital/supervised input and 1 output 12 VDC output, max load 25 mA

Connectors

I/O: 4-pin 2.5 mm terminal block
Network: Shielded RJ45 10BASE-T/100BASE-TX/1000BASE-T PoE

IR illumination

Optimized IR with power-efficient, long-life 850 nm IR LEDs
Range of reach 20 m (65 ft) or more depending on the scene

Storage

Support for microSD/microSDHC/microSDXC card
Support for SD card encryption (AES-XTS-Plain64 256bit)
Recording to network-attached storage (NAS)
For SD card and NAS recommendations see *axis.com*

Operating conditions

Temperature: -40 °C to 50 °C (-40 °F to 122 °F)
Maximum temperature according to NEMA TS 2 (2.2.7): 74 °C (165 °F)
Humidity: 10–100% RH (condensing)

Storage conditions

Temperature: -40 °C to 65 °C (-40 °F to 149 °F)
Humidity: 5–95% RH (non-condensing)

Dimensions

For the overall product dimensions, see the dimension drawing in this datasheet.
Effective Projected Area (EPA): 0.0076 m² (0.0818 ft²)

Weight

858 g (1.9 lb)

Box content

Camera, installation guide, terminal block connector, connector guard, cable gaskets, cable hole lid, owner authentication key

System tools

AXIS Site Designer, AXIS Device Manager, product selector, accessory selector, lens calculator
Available at *axis.com*

Languages

English, German, French, Spanish, Italian, Russian, Simplified Chinese, Japanese, Korean, Portuguese, Polish, Traditional Chinese, Dutch, Czech, Swedish, Finnish, Turkish, Thai, Vietnamese

Warranty

5-year warranty, see *axis.com/warranty*

Software support

New feature development until 2030 (AXIS OS 12, 13 and 14)
Support until 2035-12-31 (AXIS OS LTS 2030-2035)
Read more about the AXIS OS lifecycle at *help.axis.com/axis-os*

Part numbers

Available at *axis.com/products/axis-m4337-plve#part-numbers*

Optional accessories

Portcast

AXIS T61 MkII Audio and I/O Interface Series
AXIS D6210 Air Quality Sensor

Installation

AXIS T8415 Wireless Installation Tool

Mounting

AXIS T94K01D Pendant Kit, AXIS T94T02D Pendant Kit, AXIS TP3106-E Pendant Kit Black, AXIS TM3214 Recessed Mount, AXIS TM3215 Recessed Mount, TM3832-E Skin Cover

Storage

AXIS Surveillance Cards

For more accessories, go to *axis.com/products/axis-m4337-plve#compatible-products*

Sustainability

Substance control

PVC free, BFR/CFR free in accordance with JEDEC/ECA Standard JS709

RoHS in accordance with EU RoHS Directive 2011/65/EU and 2015/863, and standard EN IEC 63000:2018

REACH in accordance with (EC) No 1907/2006. For SCIP UUID, see echa.europa.eu

Materials

Renewable carbon-based plastic content: 33%
(recycled: 7%, bio-based: 26%)

Screened for conflict minerals in accordance with OECD guidelines

To read more about sustainability at Axis, go to axis.com/about-axis/sustainability

Environmental responsibility

axis.com/environmental-responsibility

Axis Communications is a signatory of the UN Global Compact, read more at unglobalcompact.org

Detect, Observe, Recognize, Identify (DORI)

	DORI definition	Distance (center)	Distance (corner)
Detect	25 px/m (8 px/ft)	23.1 m (75.8 ft)	34.2 m (112.2 ft)
Observe	63 px/m (19 px/ft)	9.2 m (30.2 ft)	13.6 m (44.6 ft)
Recognize	125 px/m (38 px/ft)	4.6 m (15.1 ft)	6.8 m (22.3 ft)
Identify	250 px/m (76 px/ft)	2.3 m (7.5 ft)	3.4 m (11.1 ft)

The DORI values are calculated using pixel densities for different use cases as recommended by the EN-62676-4 standard. The calculations use the center of the image as the reference point and consider lens distortion. The possibility to recognize or identify a person or object depends on factors such as object motion, video compression, lighting conditions, and camera focus. Use margins when planning. The pixel density varies across the image, and the calculated values can differ from the distances in the real world.

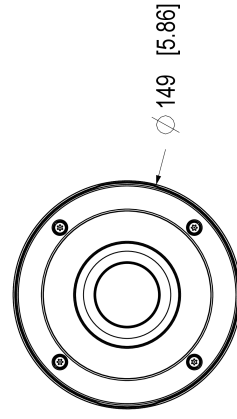
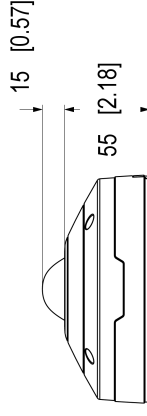
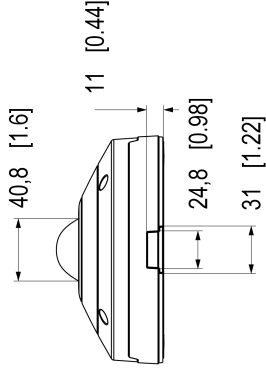
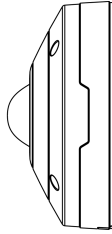
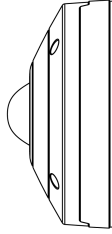
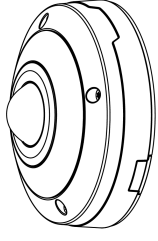
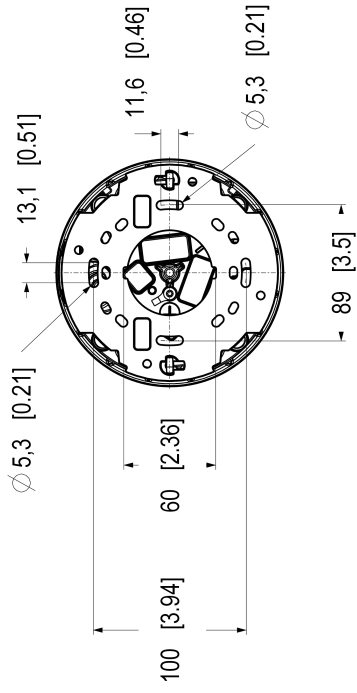

Highlighted capabilities

AV1

AV1 is a modern video encoding standard optimized for video transmission over the internet by Alliance for Open Media (AoM). It was designed to provide better compression efficiency than older codecs including H.264 (also known as AVC) and H.265 (HEVC), while being royalty-free and open-source.

Axis Edge Vault

Axis Edge Vault is the hardware-based cybersecurity platform that safeguards the Axis device. It forms the foundation that all secure operations depend on and offer features to protect the device's identity, safeguard its integrity and protect sensitive information from unauthorized access. For instance, **secure boot** ensures that a device can boot only with **signed OS**, which prevents physical supply chain tampering. With signed OS, the device is also able to validate new device software before accepting to install it. And the **secure keystore** is the critical building-block for protecting cryptographic information used for secure communication (IEEE 802.1X, HTTPS, Axis device ID, access control keys etc.) against malicious extraction in the event of a security breach. The secure keystore and secure connections are provided through a Common Criteria or FIPS 140 certified hardware-based cryptographic computing module.

Furthermore, signed video ensures that video evidence can be verified as untampered. Each camera uses its unique video signing key, which is securely stored in the secure keystore, to add a signature into the video stream allowing video to be traced back to the Axis camera from where it originated.

To read more about Axis Edge Vault, go to axis.com/solutions/edge-vault.

AXIS Image Health Analytics

This embedded AI-powered software is an intelligent application that runs directly on an Axis camera to proactively monitor and maintain its own image quality. It automatically detects common issues like blurry images, camera obstruction or tampering and scene deviations that could compromise the video's usability and sends an alert, allowing for quick and efficient troubleshooting. AXIS Image Health Analytics can also detect light malfunctions, alerting you if the scene is too dark for the camera to produce a clear image. The application is preinstalled at no extra cost and integrates with your video management system (VMS) to enable timely maintenance actions. This saves significant time and resources compared to performing manual inspections.

AXIS Object Analytics

AXIS Object Analytics is a preinstalled, multifeatured video analytics that detects and classifies humans, vehicles, and types of vehicles. Thanks to AI-based algorithms and behavioral conditions, it analyzes the scene and their spatial behavior within – all tailored to your specific needs. Scalable and edge-based, it requires minimum effort to set up and supports various scenarios running simultaneously.

For more information, see axis.com/glossary