

AXIS P1245 Mk II Modular Standard Camera

Complete, discreet standard sensor camera delivers full HD resolution

Based on the modular concept, AXIS P1245 Mk II features a thumb-sized sensor unit that connects via cable to the main unit, so the two parts can be placed separately from each other. This sensor unit is easy to install in tight spaces and can be recessed mounted to blend into the environment. Ideal for a wide range of indoor applications. The sensor can be mounted up to 15 m from the main unit and a detachable cable ensures flexible installation and upgrade. Additionally, a deep learning processing unit enables the use of advanced analytics.

- > **Small, thumb-sized sensor unit**
- > **HDTV 1080p with 111° field of view**
- > **Detachable cable up to 15 m**
- > **Support for advanced analytics**
- > **AXIS Object Analytics preinstalled**



AXIS P1245 Mk II Modular Standard Camera

Camera

Image sensor

1/2.9" progressive scan RGB CMOS
Pixel size 2.8 µm

Lens

2.8 mm, F2.0
Horizontal field of view: 111°
Vertical field of view: 61°
Minimum focus distance: 0.2 m (0.66 ft)
M12 mount, fixed iris

Minimum illumination

Color: 0.2 lux at 50 IRE, F2.0

Shutter speed

1/16500 to 1/5 s

System on chip (SoC)

Model

CV25

Memory

1024 MB RAM, 512 MB Flash

Compute capabilities

Deep learning processing unit (DLPU)

Video

Video compression

H.264 (MPEG-4 Part 10/AVC) Main and High Profiles
H.265 (MPEG-H Part 2/HEVC) Main Profile
Motion JPEG

Resolution

16:9: 1920x1080 to 640x360
16:10: 1024x640 to 640x400
4:3: 1024x768 to 480x360

Frame rate

Up to 25/30 fps (50/60 Hz) with H.264 and H.265¹ in all resolutions

Video streaming

Multiple, individually configurable streams Axis Zipstream technology in H.264 and H.265
Axis Zipstream technology in H.264 and H.265
Controllable frame rate and bandwidth
VBR/ABR/MBR H.264/H.265

Signal-to-noise ratio

>55 dB

Multi-view streaming

2 individually cropped out view areas

Image settings

Saturation, contrast, brightness, sharpness, white balance, , exposure mode, compression, rotation: 0°, 90°, 180°, 270° including corridor format, mirroring, dynamic text and image overlay, polygon privacy mask

Image processing

Axis Zipstream

Network

Network protocols

IPv4, IPv6 USGv6, ICMPv4/ICMPv6, HTTP, HTTPS², HTTP/2, TLS², QoS Layer 3 DiffServ, FTP, SFTP, CIFS/SMB, SMTP, mDNS (Bonjour), UPnP[®], SNMP v1/v2c/v3 (MIB-II), DNS/DNSv6, DDNS, NTP, PTP, NTS, RTSP, RTP, SRTP/RTSPS, TCP, UDP, IGMPv1/v2/v3, RTCP, ICMP, DHCPv4/v6, ARP, SSH, LLDP, CDP, MQTT v3.1.1, Secure syslog (RFC 3164/5424, UDP/TCP/TLS), Link-Local address (ZeroConf), IEEE 802.1X (EAP-TLS), IEEE 802.1AR

System integration

Application Programming Interface

Open API for software integration, including VAPIX[®], metadata and AXIS Camera Application Platform (ACAP); specifications at axis.com/developer-community.

One-click cloud connection

ONVIF[®] Profile G, ONVIF[®] Profile M, ONVIF[®] Profile S, and ONVIF[®] Profile T, specifications at onvif.org

1. Reduced frame rate in Motion JPEG

2. This product includes software developed by the OpenSSL Project for use in the OpenSSL Toolkit. (openssl.org), and cryptographic software written by Eric Young (ey@cryptsoft.com).

Video management systems

Compatible with AXIS Camera Station Edge, AXIS Camera Station Pro, AXIS Camera Station 5, and video management software from Axis' partners available at axis.com/vms.

Onscreen controls

Privacy masks
Media clip

Event conditions

Application
Device status: IP address blocked, IP address removed, new IP address, network lost, system ready, live stream active
Edge storage: recording ongoing, storage disruption, storage health issues detected
I/O: manual trigger, virtual input
MQTT: subscribe
Scheduled and recurring: schedule
Video: average bitrate degradation, tampering, video source connected

Event actions

LED: flash status LED
MQTT: publish
Notification: HTTP, HTTPS, TCP and email
Overlay text
Recordings: SD card and network share
SNMP traps: send, send while the rule is active
Upload of images or video clips: FTP, SFTP, HTTP, HTTPS, network share and email

Built-in installation aids

Pixel counter, level grid

Analytics

Applications

Included

AXIS Object Analytics, AXIS Scenemetadata, AXIS Video Motion Detection, AXIS Live Privacy Shield³
Support for AXIS Camera Application Platform enabling installation of third-party applications, see axis.com/acap

AXIS Object Analytics

Object classes: humans, vehicles (types: cars, buses, trucks, bikes, other)

Scenarios: line crossing, object in area, time in area, crossline counting, occupancy in area, motion in area, motion line crossing

Up to 10 scenarios

Other features: triggered objects visualized with color-coded bounding boxes

Polygon include/exclude areas

Perspective configuration

ONVIF Motion Alarm event

AXIS Scene Metadata

Object classes: humans, faces, vehicles (types: cars, buses, trucks, bikes), license plates

Object attributes: vehicle color, upper/lower clothing color, confidence, position

Approvals

Product markings

CSA, UL/cUL, CE, KC, VCCI, RCM

EMC

CISPR 35, CISPR 32 Class A, EN 55035,

EN 55032 Class A, EN 61000-6-1, EN 61000-6-2

Australia/New Zealand: RCM AS/NZS CISPR 32 Class A

Canada: ICES-3(A)/NMB-3(A)

Japan: VCCI Class A

Korea: KS C 9835, KS C 9832 Class A

USA: FCC Part 15 Subpart B Class A

Safety

CAN/CSA C22.2 No. 62368-1 ed. 3,

IEC/EN/UL 62368-1 ed. 3

Environment

IEC 60068-2-1, IEC 60068-2-2, IEC 60068-2-6,

IEC 60068-2-14, IEC 60068-2-27, IEC 60068-2-78,

IEC/EN 60529 IP3X

Network

NIST SP500-267

Cybersecurity

ETSI EN 303 645, BSI IT Security Label

Cybersecurity

Edge security

Software: Signed firmware, brute force delay protection, digest authentication and OAuth 2.0 RFC6749 Client Credential Flow/OpenID Authorization Code Flow for centralized ADFS account management, password protection

Hardware: Axis Edge Vault cybersecurity platform
Secure keystore: secure element (CC EAL 6+), system-on-chip security (TEE)
Axis device ID, signed video, secure boot, encrypted filesystem (AES-XTS-Plain64 256bit)

Network security

IEEE 802.1X (EAP-TLS, PEAP-MSCHAPv2)⁴, IEEE 802.1AE (MACsec PSK/EAP-TLS), IEEE 802.1AR, HTTPS/HSTS⁴, TLS v1.2/v1.3⁴, Network Time Security (NTS), X.509 Certificate PKI, host-based firewall

Documentation

AXIS OS Hardening Guide

Axis Vulnerability Management Policy

Axis Security Development Model

AXIS OS Software Bill of Material (SBOM)

To download documents, go to axis.com/support/cybersecurity/resources

To read more about Axis cybersecurity support, go to axis.com/cybersecurity

General

Casing

IP3X-rated

Main unit: Steel, plastic

Sensor unit: Plastic, aluminum

Color: white NCS S 1002-B

Power

Power over Ethernet (PoE) IEEE 802.3af/802.3at Type 1 Class 2

Typical 3.4 W, max 4.1 W

Connectors

Network: RJ45 10BASE-T/100BASE-TX PoE

Sensor unit: RJ12

Storage

Support for microSD/microSDHC/microSDXC card

Support for SD card encryption (AES-XTS-Plain64 256bit)

Recording to network-attached storage (NAS)

For SD card and NAS recommendations see axis.com

Operating conditions

Temperature: -20 °C to 45 °C (-4 °F to 113 °F)

Maximum temperature (intermittent): 60 °C (140 °F)

Humidity: 10–85% RH (non-condensing)

Storage conditions

Temperature: -40 °C to 65 °C (-40 °F to 149 °F)

Humidity: 5–95% RH (non-condensing)

Dimensions

For the overall product dimensions, see the dimension drawing in this datasheet.

Weight

Main unit: 75 g (0.17 lb)

Sensor unit: 16 g (0.04 lb)

Sensor unit cable: 128 g (0.28 lb)

Box content

Installation guide, owner authentication key

Main unit, sensor unit, 8 m (26 ft) black cable, 2 locking nuts

Optional accessories

AXIS T8415 Wireless Installation Tool

AXIS Surveillance Cards

For more accessories, go to axis.com/products/axis-p1245-mk-ii#accessories

System tools

AXIS Site Designer, AXIS Device Manager, product selector, accessory selector, lens calculator

Available at axis.com

Languages

English, German, French, Spanish, Italian, Russian, Simplified Chinese, Japanese, Korean, Portuguese, Polish, Traditional Chinese, Dutch, Czech, Swedish, Finnish, Turkish, Thai, Vietnamese

Warranty

5-year warranty, see axis.com/warranty

Part numbers

Available at axis.com/products/axis-p1245-mk-ii#part-numbers

4. This product includes software developed by the OpenSSL Project for use in the OpenSSL Toolkit. (openssl.org), and cryptographic software written by Eric Young (ey@cryptsoft.com).

Sustainability

Substance control

PVC free

RoHS in accordance with EU RoHS Directive 2011/65/EU and 2015/863, and standard EN IEC 63000:2018

REACH in accordance with (EC) No 1907/2006. For SCIP UUID, see echa.europa.eu

Materials

Renewable carbon-based plastic content: 73% (recycled)

Screened for conflict minerals in accordance with OECD guidelines

To read more about sustainability at Axis, go to axis.com/about-axis/sustainability

Environmental responsibility

axis.com/environmental-responsibility

Axis Communications is a signatory of the UN Global Compact, read more at unglobalcompact.org

Detect, Observe, Recognize, Identify (DORI)

	DORI definition	Distance
Detect	25 px/m (8 px/ft)	40.6 m (133.2 ft)
Observe	63 px/m (19 px/ft)	16.1 m (52.8 ft)
Recognize	125 px/m (38 px/ft)	8.1 m (26.6 ft)
Identify	250 px/m (76 px/ft)	4.1 m (13.5 ft)

The DORI values are calculated using pixel densities for different use cases as recommended by the EN-62676-4 standard. The calculations use the center of the image as the reference point and consider lens distortion. The possibility to recognize or identify a person or object depends on factors such as object motion, video compression, lighting conditions, and camera focus. Use margins when planning. The pixel density varies across the image, and the calculated values can differ from the distances in the real world.

Dimension drawing

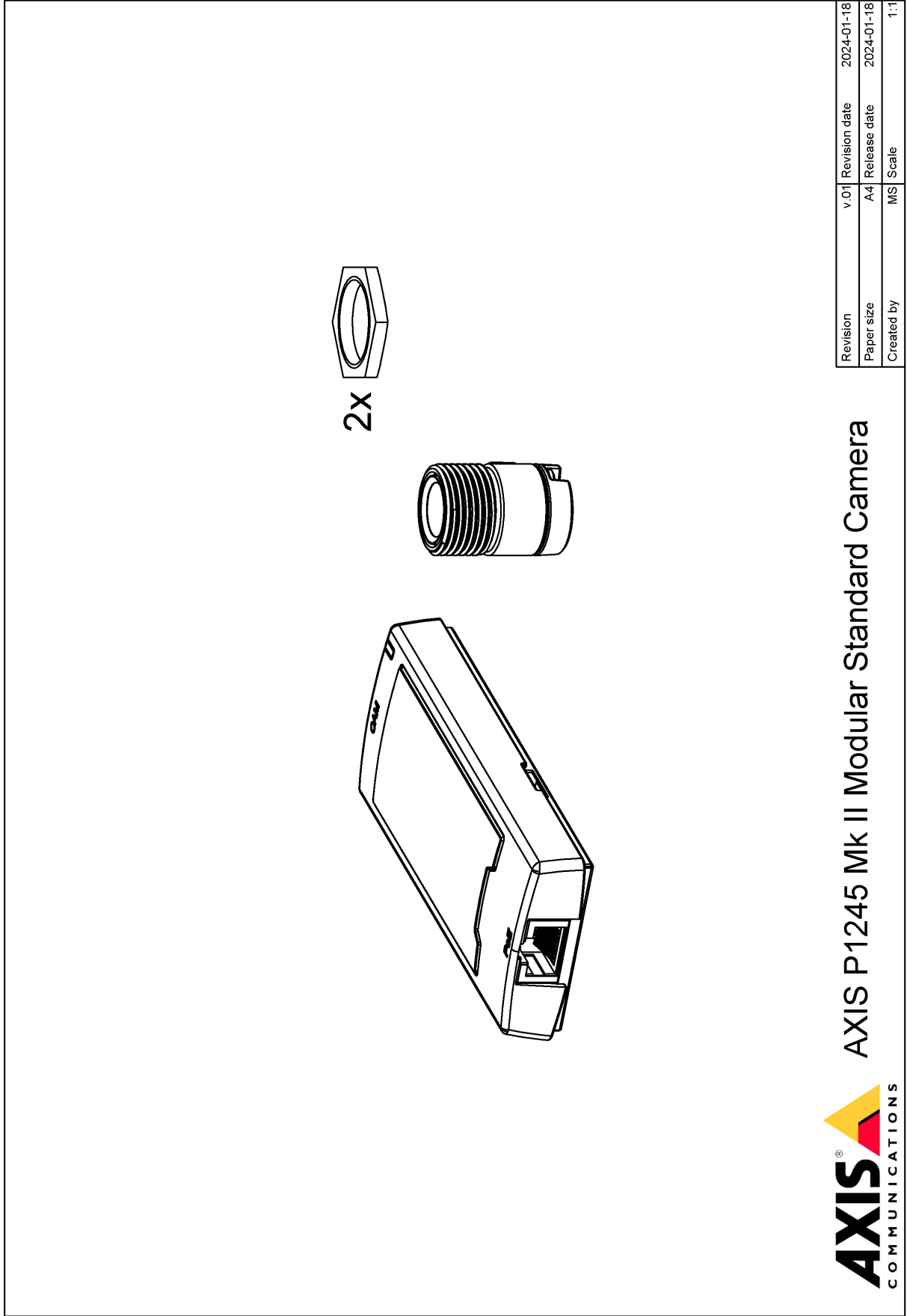

Revision	v.01	Revision date	2024-01-18
Paper size	A4	Release date	2024-01-18
Created by	MS	Scale	1:1

© 2024 Axis Communications



www.axis.com

AXIS P1245 Mk II Modular Standard Camera



Revision	v.01	Revision date	2024-01-18
Paper size	A4	Release date	2024-01-18
Created by	MS	Scale	1:2

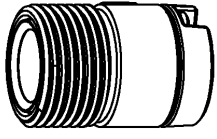

Ø20mm [Ø0.79"]

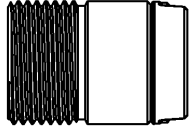
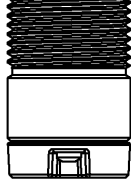

29mm [1.15"]

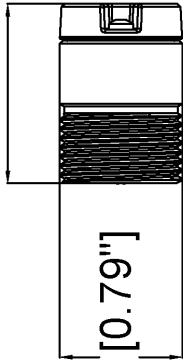

20mm [0.79"]

Revision	v.01	Revision date	2024-01-18
Paper size	A4	Release date	2024-01-18
Created by	MS	Scale	1:1

Ø19mm [Ø0.73"]

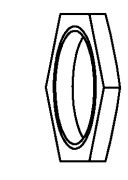

24mm [0.94"]

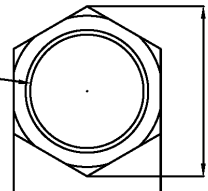

28mm [1.09"]

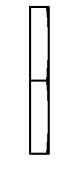

3mm [0.12"]

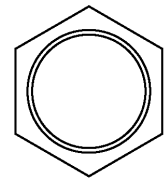
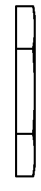
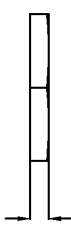

Revision	v.01	Revision date	2024-01-18
Paper size	A4	Release date	2024-01-18
Created by	MS	Scale	1:1

Highlighted capabilities

AXIS Object Analytics

AXIS Object Analytics is a preinstalled, multifeatured video analytics that detects and classifies humans, vehicles, and types of vehicles. Thanks to AI-based algorithms and behavioral conditions, it analyzes the scene and their spatial behavior within – all tailored to your specific needs. Scalable and edge-based, it requires minimum effort to set up and supports various scenarios running simultaneously.

for example to make the product cover wider areas, or to make it focus on details or objects of interest.

For more information, see [axis.com/glossary](https://www.axis.com/glossary)

AXIS Live Privacy Shield

Remotely monitor activities both indoors and outdoors while safeguarding privacy in real-time.

With AI-based dynamic masking you can choose what to mask or blur while addressing rules and regulations protecting privacy and personal data. The application enables masking of moving and still objects such as humans, license plates, or backgrounds. The application works in real-time and on both live and recorded video streams.

Axis Edge Vault

Axis Edge Vault is the hardware-based cybersecurity platform that safeguards the Axis device. It forms the foundation that all secure operations depend on and offer features to protect the device's identity, safeguard its integrity and protect sensitive information from unauthorized access. For instance, **secure boot** ensures that a device can boot only with **signed OS**, which prevents physical supply chain tampering. With signed OS, the device is also able to validate new device software before accepting to install it. And the **secure keystore** is the critical building-block for protecting cryptographic information used for secure communication (IEEE 802.1X, HTTPS, Axis device ID, access control keys etc.) against malicious extraction in the event of a security breach. The secure keystore and secure connections are provided through a Common Criteria or FIPS 140 certified hardware-based cryptographic computing module.

Furthermore, signed video ensures that video evidence can be verified as untampered. Each camera uses its unique video signing key, which is securely stored in the secure keystore, to add a signature into the video stream allowing video to be traced back to the Axis camera from where it originated.

To read more about Axis Edge Vault, go to [axis.com/solutions/edge-vault](https://www.axis.com/solutions/edge-vault).

Exchangeable lenses

Different lens options offer the opportunity to adjust the field of view (FoV) of the product, and thereby adapt it to your chosen area of use. The lens can be easily changed,