

AXIS T8310 Video Surveillance Control Board

AXIS T8311 Video Surveillance Joystick

AXIS T8312 Video Surveillance Keypad

AXIS T8313 Video Surveillance Jog Dial

Installation Guide

English

EN

France: Français

FR

Deutschland: Deutsch

DE

Italia: Italiano

IT

España: Español

ES

日本: 日本語

JA

中文: 简体中文

ZH

AXIS T8310 Video Surveillance Control Board

Read this first

Read through this Installation Guide carefully before installing the product. Keep the Installation Guide for future reference.

Legal considerations

Video and audio surveillance can be regulated by laws that vary from country to country. Check the laws in your local region before using this product for surveillance purposes.

Liability

Every care has been taken in the preparation of this document. Please inform your local Axis office of any inaccuracies or omissions. Axis Communications AB cannot be held responsible for any technical or typographical errors and reserves the right to make changes to the product and manuals without prior notice. Axis Communications AB makes no warranty of any kind with regard to the material contained within this document, including, but not limited to, the implied warranties of merchantability and fitness for a particular purpose. Axis Communications AB shall not be liable nor responsible for incidental or consequential damages in connection with the furnishing, performance or use of this material. This product is only to be used for its intended purpose.

Intellectual property rights

Axis AB has intellectual property rights relating to technology embodied in the product described in this document. In particular, and without limitation, these intellectual property rights may include one or more of the patents listed at axis.com/patent and one or more additional patents or pending patent applications in the US and other countries.

Equipment modifications

This equipment must be installed and used in strict accordance with the instructions given in the user documentation. This equipment contains no user-serviceable components. Unauthorized equipment changes or modifications will invalidate all applicable regulatory certifications and approvals.

Trademark acknowledgements

AXIS COMMUNICATIONS, AXIS and VAPIX are registered trademarks or trademark applications of Axis AB in various jurisdictions. All other company names and products are trademarks or registered trademarks of their respective companies.

Regulatory information

Europe



This product complies with the applicable CE marking directives and harmonized standards:

- Restriction of Hazardous Substances (RoHS) Directive 2011/65/EU and 2015/863, including any amendments, updates or replacements. See *Disposal and recycling on page 7*.

A copy of the original declaration of conformity may be obtained from Axis Communications AB. See *Contact information on page 8*.

Regulatory information

Europe



This product complies with the applicable CE marking directives and harmonized standards:

- Electromagnetic Compatibility (EMC) Directive 2014/30/EU. See *Electromagnetic compatibility (EMC) on page 5*.
- Low Voltage Directive (LVD) 2014/35/EU. See *Safety on page 7*.
- Restriction of Hazardous Substances (RoHS) Directive 2011/65/EU and 2015/863, including any amendments, updates or replacements. See *Disposal and recycling on page 7*.

A copy of the original declaration of conformity may be obtained from Axis Communications AB. See *Contact information on page 8*.

Electromagnetic compatibility (EMC)

This equipment has been designed and tested to fulfill applicable standards for:

- Radio frequency emission when installed according to the instructions and used in its intended environment.
- Immunity to electrical and electromagnetic phenomena when installed according to the instructions and used in its intended environment.

USA

This device complies with part 15 of the FCC Rules. Operation is subject to the following two conditions:

1. This device may not cause harmful interference, and

AXIS T8310 Video Surveillance Control Board

2. this device must accept any interference received, including interference that may cause undesired operation.

This equipment has been tested and found to comply with the limits for a Class B digital device, pursuant to part 15 of the FCC Rules. These limits are designed to provide reasonable protection against harmful interference in a residential installation. This equipment generates, uses and can radiate radio frequency energy and, if not installed and used in accordance with the instructions, may cause harmful interference to radio communications. However, there is no guarantee that interference will not occur in a particular installation. If this equipment does cause harmful interference to radio or television reception, which can be determined by turning the equipment off and on, the user is encouraged to try to correct the interference by one or more of the following measures:

- Reorient or relocate the receiving antenna.
- Increase the separation between the equipment and receiver.
- Connect the equipment into an outlet on a circuit different from that to which the receiver is connected.
- Consult the dealer or an experienced radio/TV technician for help.

The product shall be properly grounded.

Contact information

Axis Communications Inc.
300 Apollo Drive
Chelmsford, MA 01824
United States of America
Tel: +1 978 614 2000

Canada

This digital apparatus complies with CAN ICES-3 (Class B). The product shall be properly grounded. Cet appareil numérique est conforme à la norme CAN NMB-3 (classe B). Le produit doit être correctement mis à la terre.

Europe

This digital equipment fulfills the requirements for RF emission according to the Class B limit of EN 55032. The product shall be properly grounded.

Australia/New Zealand

This digital equipment fulfills the requirements for RF emission according to the Class B limit of AS/NZS CISPR 32. The product shall be properly grounded.

Japan

この装置は、クラスB機器です。この装置は、住宅環境で使用することを目的としていますが、この装置がラジオやテレビジョン受信機に近接して使用されると、受信障害を引き起こすことがあります。取扱説明書に従って正しい取り扱いをして下さい。VCCI-B

Korea

AXIS T8310 Video Surveillance Control Board

이 기기는 가정용(B급) 전자파적합기기로서 주로 가정에서 사용하는 것을 목적으로 하며, 모든 지역에서 사용할 수 있습니다. 제품은 적합하게 접지 되어야 합니다.

Safety

This product complies with IEC/EN/UL 62368-1, safety of audio/video and IT equipment.

Disposal and recycling

When this product has reached the end of its useful life, dispose of it according to local laws and regulations. For information about your nearest designated collection point, contact your local authority responsible for waste disposal. In accordance with local legislation, penalties may be applicable for incorrect disposal of this waste.

Europe



This symbol means that the product shall not be disposed of together with household or commercial waste. Directive 2012/19/EU on waste electrical and electronic equipment (WEEE) is applicable in the European Union member states. To prevent potential harm to human health and the environment, the product must be disposed of in an approved and environmentally safe recycling process. For information about your nearest designated collection point, contact your local authority responsible for waste disposal. Businesses should contact the product supplier for information about how to dispose of this product correctly.

This product complies with the requirements of Directive 2011/65/EU and 2015/863 on the restriction of the use of certain hazardous substances in electrical and electronic equipment (RoHS).

China



This product complies with the requirements of SJ/T 11364-2014, Marking for the restriction of hazardous substances in electrical and electronic products.

有毒有害物质或元素						
部件名称	铅 (Pb)	汞 (Hg)	镉 (Cd)	六价铬 (Cr(VI))	多溴联苯 (PBB)	多溴二苯 醚 (PBDE)

AXIS T8310 Video Surveillance Control Board

电气 安装 部分	X	0	0	0	0	0
----------------	---	---	---	---	---	---

0: 表示该有毒有害物质在该部件均质材料中的含量均在GB/T 26572标准规定的限量要求以下。

X: 表示该有毒有害物质至少在该部件的某一均质材料中的含量超出GB/T 26572标准规定的限量要求。

Contact information

Axis Communications AB
Emdalavägen 14
223 69 Lund
Sweden

Tel: +46 46 272 18 00
Fax: +46 46 13 61 30

axis.com

Warranty information

For information about Axis' product warranty and thereto related information, go to axis.com/warranty.

Support

Should you require any technical assistance, please contact your Axis reseller. If your questions cannot be answered immediately, your reseller will forward your queries through the appropriate channels to ensure a rapid response. If you are connected to the Internet, you can:

- find answers to resolved problems in the FAQ database, search by product, category, or phrase
- report problems to Axis support staff by logging in to your private support area
- chat with Axis support staff
- visit Axis Support at axis.com/support

AXIS T8310 Video Surveillance Control Board

Learn more!

Visit Axis learning center axis.com/academy for useful trainings, webinars, tutorials and guides.

Installation Guide

This Installation Guide provides instructions for installing AXIS T8310 Video Surveillance Control Board. For all other aspects of using the product, please see the AXIS Camera Station help pages.

Overview

The three units in AXIS T8310 Video Surveillance Control Board can be installed separately or together as one unit. Power is provided via the USB connections.

Package contents

Item	Models/variants/notes
Joystick/Keypad/Jog dial	AXIS T8311/ AXIS T8312/ AXIS T8313
USB cables	AXIS T8311: 1 x 200 cm (78.7 in) when sold separately, connects to PC only
	AXIS T8312: 1 x 40 cm (15.7 in) for connection between units, 1 x 200 cm for connection to PC
	AXIS T8313: 1 x 40 cm 1 x 80 cm (31.5 in) for connection of two units to keypad

Hardware overview

AXIS T8310 Video Surveillance Control Board

- 1: AXIS T8311 Video Surveillance Joystick
- 2: AXIS T8312 Video Surveillance Keypad
- 3: AXIS T8313 Video Surveillance Jog Dial

Note

All keys on all units are fully customizable from the supporting software. Some keys have a default value, which is listed with the product overview.

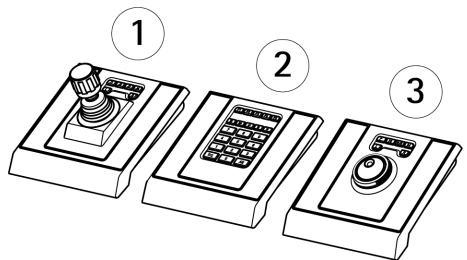

AXIS T8310 Video Surveillance Control Board

AXIS T8311 Joystick

- 1: USB port
- 2: 6 fully customizable keys
- 3: Joystick

Key default values:

J1-J4 - No defaults

L - Simulate left mouse button click

R - Simulate right mouse button click

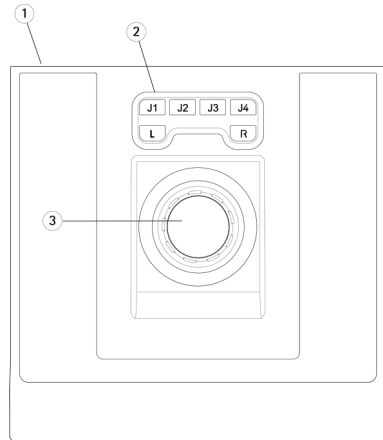

AXIS T8312 Keypad

- 1: USB port (x2)
- 2: 22 fully customizable keys
- 3: USB port

Key default values:

F1 - No default

F2 - Open hotkeys tab

F3 - No default

F4 - Open Logs tab

F5 - Open Configuration tab

 - Open views

 - Next camera/view

 - No default

 - No default

 - No default

 - Go to right tab

 + Alt = Go to left tab

0-9 = 0-9

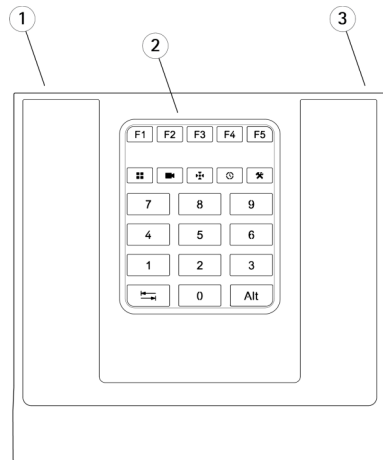

AXIS T8313 Jog dial

- 1: USB port
- 2: 6 fully customizable keys
- 3: Shuttle wheel
- 4: Jog wheel

Key default values:

- ▶ - Add bookmark
- ◀ - Go to previous recording
- ▶/|| - Play/Pause
- ▶▶ - Go to next recording
- L - Show/hide export markers
- R - Switch between live/recordings

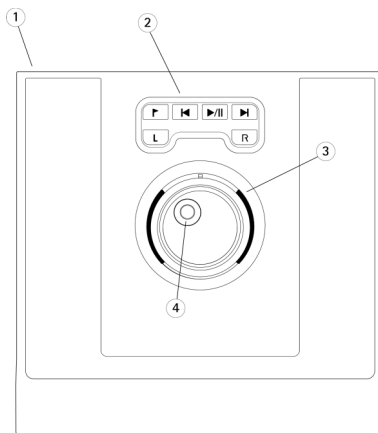

Install the hardware

AXIS T8311 Video Surveillance Joystick, AXIS T8312 Video Surveillance Keypad and AXIS T8313 Video Surveillance Jog Dial can be connected separately, or together as a unit, using AXIS T8312 Video Surveillance Keypad as a USB hub. The units can be placed in any order, to meet your own requirements.

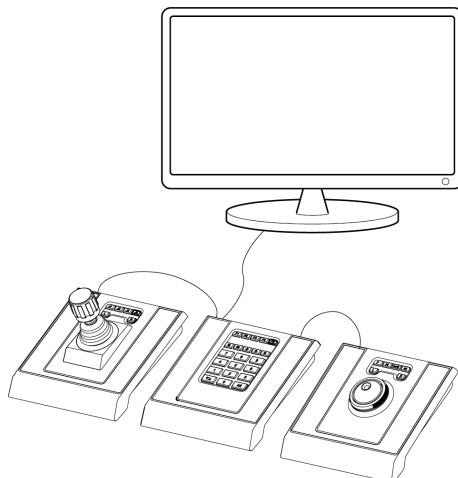

AXIS T8310 Video Surveillance Control Board

1. Connect the USB cable to a USB port on your computer.
2. Follow the onscreen instructions (if applicable) to install the necessary drivers. The AXIS T8311 joystick will appear as a game controller/device in Windows.
3. Start the supporting application software, e.g. AXIS Camera Station, which will automatically detect the devices in the AXIS T8310.

Note

The system must have a supporting application software, e.g. AXIS Camera Station, that can detect the new hardware. See axis.com for information on supporting systems.

Troubleshooting

If you experience problems during the installation, please try the following:

- Restart the supporting application software, e.g. AXIS Camera Station.
- Disconnect the USB cable from the computer, wait 10 seconds and then reconnect.
- Move the USB cable to another available USB port on your computer.
- Verify that the operating system has identified the joystick. This can be checked in Windows device manager.

Guide d'installation

Ce guide d'installation explique comment installer le Tableau de contrôle de vidéosurveillance AXIS T8310. Pour toutes les autres informations relatives à l'utilisation du produit, reportez-vous aux pages de l'aide AXIS Camera Station.

Vue d'ensemble

FR

Les trois unités du Tableau de contrôle de vidéosurveillance AXIS T8310 peuvent être installées séparément ou ensemble en une seule unité. L'alimentation est fournie via les connexions USB.

Contenu de l'emballage

Article	Modèles/variantes/remarques	
Joystick/Clavier/Molette	AXIS T8311/ AXIS T8312/ AXIS T8313	
Câbles USB	AXIS T8311 :	1 x 200 cm (78,7 po) s'il est vendu séparément, se connecte uniquement au PC
	AXIS T8312 :	1 x 40 cm (15,7 po) pour la connexion entre deux unités, 1 x 200 cm pour le raccordement au PC
	AXIS T8313 :	1 x 40 cm 1 x 80 cm (31,5 po) pour la connexion de deux unités au clavier

Aperçu du matériel

Tableau de contrôle de vidéosurveillance AXIS T8310

- 1: Joystick de vidéosurveillance AXIS T8311
- 2: Clavier de vidéosurveillance AXIS T8312
- 3: Molette de vidéosurveillance AXIS T8313

Note

Toutes les touches sur toutes les unités sont entièrement personnalisables depuis le logiciel de soutien. Certaines touches ont une valeur par défaut, qui est indiquée dans la présentation du produit.

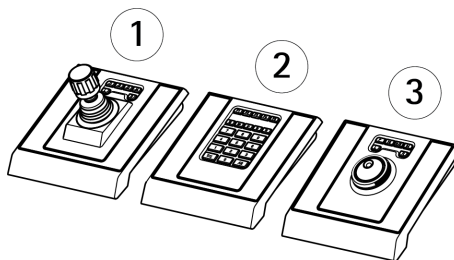

AXIS T8310 Video Surveillance Control Board

Joystick AXIS T8311

- 1: Port USB
- 2 : 6 touches entièrement personnalisables
- 3 : Joystick

Valeur par défaut des clés :

J1-J4 - Pas de valeurs par défaut

L - Simule un clic gauche de la souris

R - Simule un clic droit de la souris

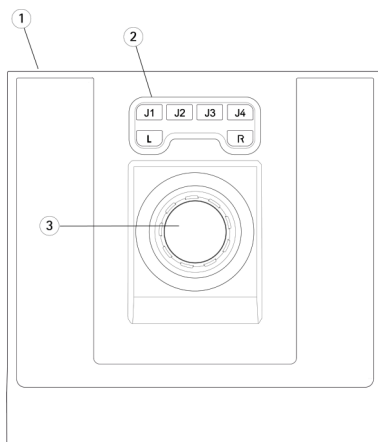

Clavier AXIS T8312

- 1: Port USB (x2)
- 2 : 22 touches entièrement personnalisables
- 3 : Port USB

Valeur par défaut des clés :

F1 - Pas de valeur par défaut

F2 - Ouvrir onglet touches de raccourci

F3 - Pas de valeur par défaut

F4 - Ouvrir onglet Journaux

F5 - Ouvrir onglet Configuration

 - Ouvrir vues

 - Caméra suivante/vue

 - Pas de valeur par défaut

 - Pas de valeur par défaut

 - Pas de valeur par défaut

 - Aller à l'onglet droit

 + Alt = Aller à l'onglet gauche

0-9 = 0-9

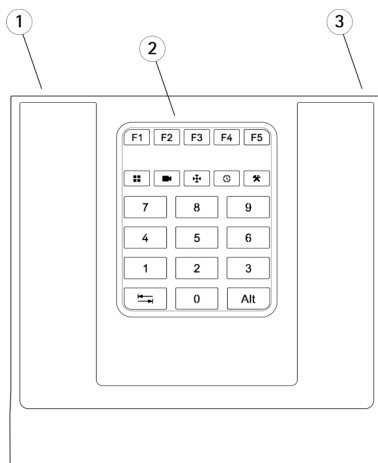

Molette AXIS T8313

- 1: Port USB
- 2 : 6 touches entièrement personnalisables
- 3 : Molette de défilement
- 4 : Roue de défilement

Valeur par défaut des clés :

- ▶ - Ajouter un signet
- ◀ - Aller à l'enregistrement précédent
- ▶|| - Lecture/Pause
- ▶ - Aller à l'enregistrement suivant
- L - Afficher/masquer les marqueurs d'exportation
- R - Passer de diffusion en direct à enregistrements

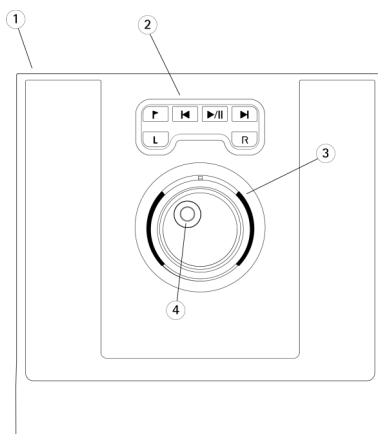

FR

Installation du matériel

Le joystick de vidéosurveillance AXIS T8311, le clavier de vidéosurveillance AXIS T8312 et la molette de vidéosurveillance AXIS T8313 peuvent être raccordés séparément ou ensemble en une seule unité, en utilisant le clavier de vidéosurveillance AXIS T8312 comme concentrateur USB. Pour répondre à vos besoins, vous pouvez placer les unités dans l'ordre de votre choix.

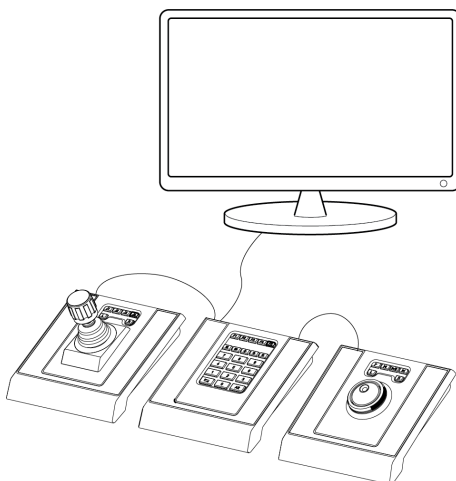

AXIS T8310 Video Surveillance Control Board

1. Connectez le câble USB à un port USB de votre ordinateur.
2. Suivez les instructions qui s'affichent à l'écran (le cas échéant) pour installer les pilotes nécessaires. Le joystick AXIS T8311 apparaît comme une console de jeu/un périphérique dans Windows.
3. Démarrez le logiciel d'application, à savoir AXIS Camera Station, qui détectera automatiquement les périphériques sur l'AXIS T8310.

Note

Le système doit disposer d'un logiciel d'application, à savoir AXIS Camera Station, qui peut détecter le nouveau matériel. Consultez axis.com pour plus d'informations sur les systèmes d'exploitation.

Dépannage

Si vous rencontrez un problème lors de l'installation, essayez les procédures suivantes :

- Redémarrez le logiciel d'application, à savoir AXIS Camera Station.
- Débranchez le câble USB de l'ordinateur, attendez 10 secondes, puis rebranchez-le.
- Déplacez le câble USB vers un autre port USB disponible de votre ordinateur.
- Vérifiez que le système d'exploitation a identifié le joystick. Vous pouvez le vérifier dans le gestionnaire des périphériques Windows.

Installationsanleitung

In dieser Anleitung wird die Installation der AXIS T8310 Steuerungseinheit zur Sicherheitsüberwachung beschrieben. Alle weiteren Informationen zur Nutzung dieses Produktes finden Sie auf den Hilfeseiten zu AXIS Camera Station.

Übersicht

Die drei Geräte in der AXIS T8310 Steuerungseinheit zur Sicherheitsüberwachung können getrennt oder gemeinsam installiert werden. Die Stromversorgung erfolgt über die USB-Anschlüsse.

DE

Lieferumfang

Artikel	Modelle/Varianten/Hinweise
Joystick/Tastenfeld/Jog Dial	AXIS T8311/AXIS T8312/AXIS T8313
USB-Kabel	AXIS T8311: 1 x 200 cm (bei separatem Kauf), nur für den Anschluss an einen PC
	AXIS T8312: 1 x 40 cm für Verbindungen zwischen den Geräten, 1 x 200 cm für den Anschluss an einen PC
	AXIS T8313: 1 x 40 cm 1 x 80 cm für den Anschluss von zwei Geräten an ein Tastenfeld

Übersicht über die Hardware

AXIS T8310 Steuerungseinheit zur Sicherheitsüberwachung

AXIS T8310 Video Surveillance Control Board

- 1: AXIS T8311 Joystick Videoüberwachung
- 2: AXIS T8312 Funktionstastenfeld Videoüberwachung
- 3: AXIS T8313 Jog Dial Videoüberwachung

Beachten

Die Funktion sämtlicher Tasten aller Geräte lässt sich mithilfe der entsprechenden Software frei programmieren. Einigen Tasten ist ein Standardwert zugewiesen. Dieser ist in der Produktübersicht aufgeführt.

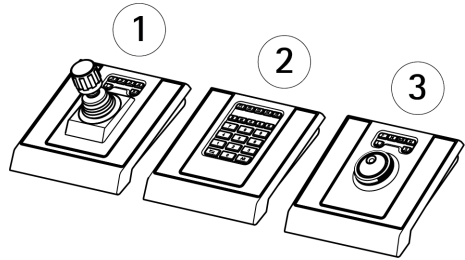

AXIS T8311 Joystick

- 1: USB-Port
- 2: 6 frei programmierbare Tasten
- 3: Joystick

Standardwerte der Tasten:
J1–J4 - Keine Standardwerte
L - Linksklick simulieren
R - Rechtsklick simulieren

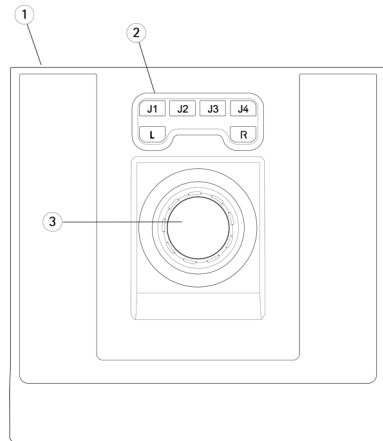







AXIS T8312 Funktionstastenfeld

AXIS T8310 Video Surveillance Control Board

- 1: USB-Port (2x)
- 2: 22 frei programmierbare Tasten
- 3: USB-Port

Standardwerte der Tasten:

- F1 - Kein Standardwert
- F2 - Hotkey-Registerkarte öffnen
- F3 - Kein Standardwert
- F4 - Protokollregisterkarte öffnen
- F5: Konfigurationsregisterkarte öffnen

-  - Ansichten öffnen
 -  - Nächste Kamera/Ansicht
 -  - Kein Standardwert
 -  - Kein Standardwert
 -  - Kein Standardwert
 -  - Zur rechten Registerkarte wechseln
 -  + Alt = zur linken Registerkarte wechseln
- 0-9 = 0-9

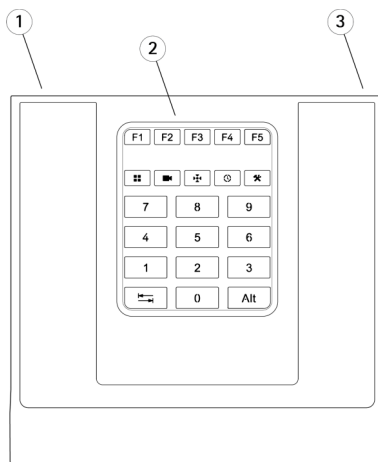





DE

AXIS T8313 Jog Dial

- 1: USB-Port
- 2: 6 frei programmierbare Tasten
- 3: Auswahlrاد
- 4: Jog-Rad

Standardwerte der Tasten:

-  - Lesezeichen hinzufügen
-  - Zur vorherigen Aufzeichnung
-  - Wiedergabe/Pause
-  - Zur nächsten Aufzeichnung
- L - Exportmarkierungen einblenden/ausblenden
- R - Zwischen den Optionen Live und Aufzeichnung wechseln

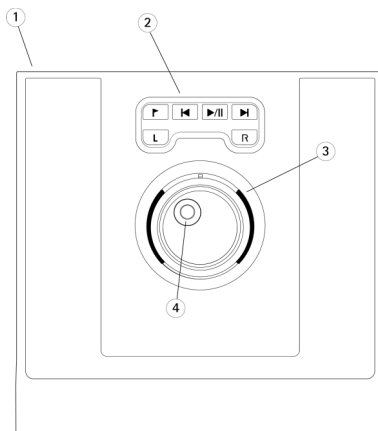

Installieren der Hardware

Die Produkte AXIS T8311 Joystick Videoüberwachung, AXIS T8312 Funktionstastenfeld Videoüberwachung und AXIS T8313 Jog Dial Videoüberwachung können getrennt oder gemeinsam als ein Gerät angeschlossen werden, wobei das AXIS T8312 Funktionstastenfeld Videoüberwachung als USB-Hub fungiert. Die Einheiten können nach Bedarf in beliebiger Reihenfolge angeordnet werden.

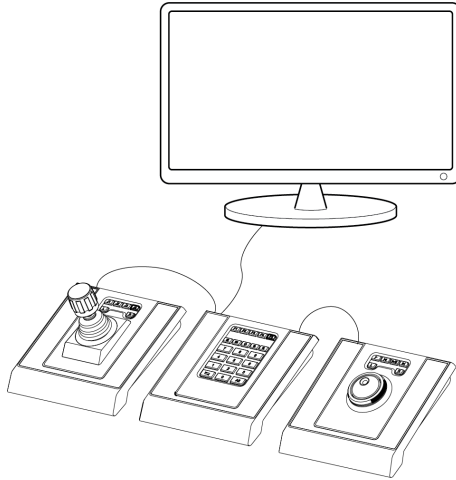

1. Schließen Sie das USB-Kabel an einen USB-Port Ihres Computers an.
2. Führen Sie ggf. die Anweisungen auf dem Bildschirm aus, um die erforderlichen Treiber zu installieren. Der AXIS T8311 Joystick wird in Windows als Gamecontroller/-gerät angezeigt.
3. Starten Sie die zugehörige Anwendungssoftware (z. B. AXIS Camera Station), die die Geräte in der AXIS T8310 automatisch erkennt.

Beachten

Für das System ist eine zugehörige Anwendungssoftware (z. B. AXIS Camera Station) erforderlich, die die neue Hardware erkennen kann. Unter axis.com finden Sie Informationen zu zugehörigen Systemen.

Fehlerbehebung

Versuchen Sie Folgendes, wenn bei der Installation Probleme auftreten:

- Starten Sie die zugehörige Anwendungssoftware (z. B. AXIS Camera Station) neu.
- Trennen Sie das USB-Kabel vom Computer, warten Sie 10 Sekunden und schließen Sie das Kabel wieder an.

AXIS T8310 Video Surveillance Control Board

- Schließen Sie das USB-Kabel an einen anderen USB-Port Ihres Computers an.
- Überprüfen Sie, ob das Betriebssystem den Joystick erkannt hat. Dies lässt sich im Windows-Gerätmanager überprüfen.

Installation Guide

This Installation Guide provides instructions for installing AXIS T8310 Video Surveillance Control Board. For all other aspects of using the product, please see the AXIS Camera Station help pages.

Panoramica

Le tre unità in AXIS T8310 Video Surveillance Control Board possono essere installate separatamente oppure come un'unica unità. L'alimentazione è fornita tramite connessioni USB.

Contenuto della confezione

Elemento	Modelli/varianti/note	
Joystick/Tastierina/Jog dial	AXIS T8311/ AXIS T8312/ AXIS T8313	
Cavi USB	AXIS T8311:	1 x 200 cm se venduto separatamente, si collega solo a PC
	AXIS T8312:	1 x 40 cm per il collegamento tra unità, 1 x 200 cm per il collegamento al PC
	AXIS T8313:	1 x 40 cm 1 x 80 cm per il collegamento di due unità alla tastiera

IT

Panoramica dell'hardware

AXIS T8310 Video Surveillance Control Board (AXIS T8310 Video Surveillance Control Board)

- 1: AXIS T8311 Video Surveillance Joystick
- 2: AXIS T8312 Video Surveillance Keypad
- 3: AXIS T8313 Video Surveillance Jog Dial

Nota

Tutti i tasti su tutte le unità sono completamente personalizzabili dal software di supporto. Alcuni tasti hanno un valore predefinito, elencato nella panoramica del dispositivo.

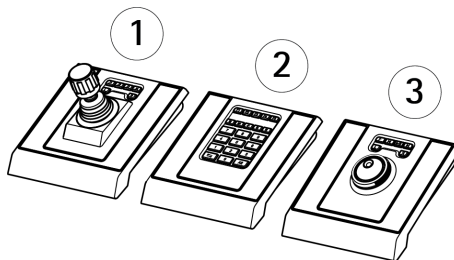

AXIS T8310 Video Surveillance Control Board

AXIS T8311 Joystick (Joystick AXIS T8311)

- 1: Porta USB
- 2: 6 tasti completamente personalizzabili
- 3: Joystick

Valori predefiniti dei tasti:

J1-J4 - Nessun valore predefinito

L - Simula il clic del pulsante sinistro del mouse

R - Simula il clic del pulsante destro del mouse

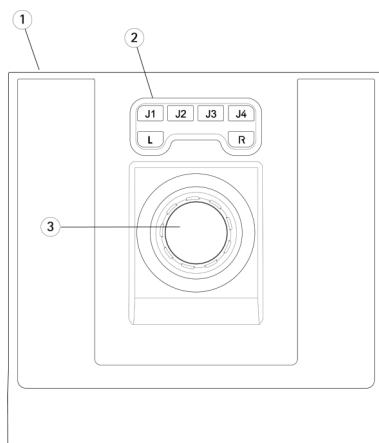

AXIS T8312 Keypad (Tastiera AXIS T8312)

- 1: Porta USB (x2)
- 2: 22 tasti completamente personalizzabili
- 3: porta USB

Valori predefiniti dei tasti:

F1 - Nessun valore predefinito

F2 - Apri scheda tasti di scelta rapida

F3 - Nessun valore predefinito

F4 - Apri scheda Registri

F5 - Apri scheda Configurazione

 - Apri viste

 - Telecamera/vista successiva

 - Nessun valore predefinito

 - Nessun valore predefinito

 - Nessun valore predefinito

 - Vai a scheda destra

 + Alt = Vai a scheda sinistra

0-9 = 0-9

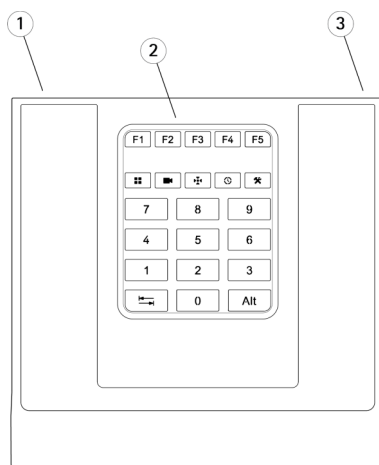

AXIS T8313 Jog dial (AXIS T8313 Jog dial)

- 1: Porta USB
- 2: 6 tasti completamente personalizzabili
- 3: Rotellina shuttle
- 4: Rotellina Jog

Valori predefiniti dei tasti:

- ▶ - Aggiungi segnalibro
- ◀ - Passa alla registrazione precedente
- ▶/|| - Riproduci/Pausa
- ▶▶ - Passa alla registrazione successiva
- L - Mostra o nascondi indicatori di esportazione
- R - Passaggio dalle immagini dal vivo alle registrazioni

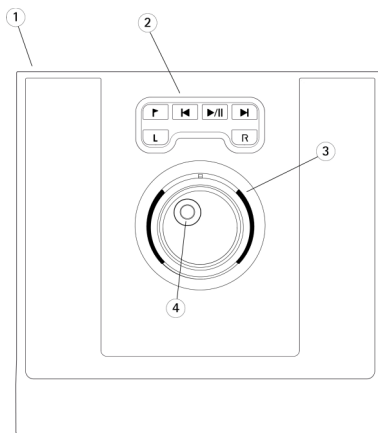

IT

Installazione dell'hardware

AXIS T8311 Video Surveillance Joystick, AXIS T8312 Video Surveillance Keypad e AXIS T8313 Video Surveillance Jog Dial possono essere collegati separatamente o come unica unità, utilizzando AXIS T8312 Video Surveillance Keypad come hub USB. Le unità possono essere posizionate in qualsiasi ordine, a seconda delle esigenze.

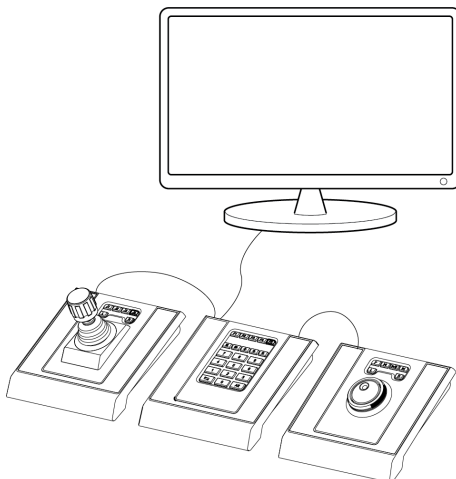

AXIS T8310 Video Surveillance Control Board

1. Collegare il cavo USB a una porta USB sul computer.
2. Seguire le istruzioni visualizzate (se applicabili) per installare i driver necessari. Il joystick AXIS T8311 verrà visualizzato come dispositivo o controller di gioco in Windows.
3. Avviare il software dell'applicazione di supporto, ad esempio AXIS Camera Station, che rileverà automaticamente i dispositivi in AXIS T8310.

Nota

Il sistema deve disporre di un software dell'applicazione di supporto, ad esempio AXIS Camera Station, in grado di rilevare il nuovo hardware. Visitare il sito [Web axis.com](http://www.axis.com) per informazioni sui sistemi di supporto.

Risoluzione di problemi

Se si sono verificati problemi durante l'installazione, provare una delle seguenti soluzioni:

- Riavviare il software dell'applicazione di supporto, ad esempio AXIS Camera Station.
- Scollegare il cavo USB dal computer, attendere 10 secondi, quindi ricollegarlo.
- Collegare il cavo USB a un'altra porta USB disponibile sul computer.
- Verificare che il sistema operativo abbia identificato il joystick da Gestione dispositivi in Windows.

Guía de instalación

En esta guía de instalación se proporcionan las instrucciones necesarias para instalar la AXIS T8310 Video Surveillance Control Board. Para los demás aspectos relacionados con el uso del producto, consulte las páginas de ayuda de AXIS Camera Station.

Información general

Las tres unidades de la AXIS T8310 Video Surveillance Control Board se pueden instalar por separado o juntas como una unidad. Se suministra la corriente a través de las conexiones USB.

Contenido del paquete

Artículo	Modelos/variantes/notas	
Joystick/Teclado/Mando de control secuencial	AXIS T8311/ AXIS T8312/ AXIS T8313	
Cables USB	AXIS T8311:	1 x 200 cm si se vende por separado, se conecta solo al PC
	AXIS T8312:	1 x 40 cm para conexión entre unidades, 1 x 200 cm para conexión al PC
	AXIS T8313:	1 x 40 cm 1 x 80 cm para conexión de dos unidades al teclado

ES

Información general del hardware

AXIS T8310 Video Surveillance Control Board

- 1: AXIS T8311 Video Surveillance Joystick
- 2: AXIS T8312 Video Surveillance Keypad
- 3: AXIS T8313 Video Surveillance Jog Dial

Nota

Todas las teclas de todas las unidades se pueden personalizar mediante el software compatible. Algunas teclas ya poseen un valor predeterminado asignado que se detalla en la información general del producto.

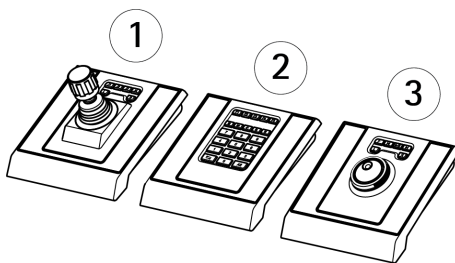

AXIS T8310 Video Surveillance Control Board

AXIS T8311 Joystick

- 1: Puerto USB
- 2: 6 teclas totalmente personalizables
- 3: Joystick

Valores predeterminados de tecla:

J1–J4: Sin valores predeterminados

L: Simula el clic en el botón izquierdo del ratón

R: Simula el clic en el botón derecho del ratón

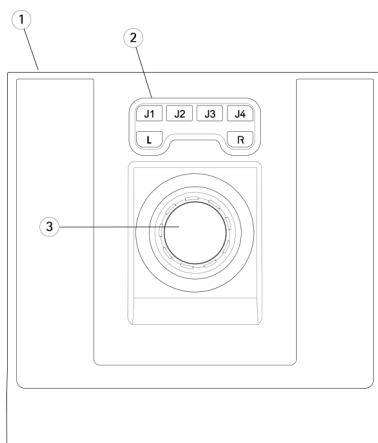

AXIS T8312 Keypad

- 1: Puerto USB (2)
- 2: 22 teclas totalmente personalizables
- 3: Puerto USB

Valores predeterminados de tecla:

F1: Sin valor predeterminado

F2: Abrir pestaña de teclas de acceso directo

F3: Sin valor predeterminado

F4: Abrir pestaña de registros

F5: Abrir pestaña de configuración

: Abrir vistas

: Siguiete cámara/vista

: Sin valor predeterminado

: Sin valor predeterminado

: Sin valor predeterminado

: Ir a pestaña de la derecha

 + Alt = Ir a pestaña de la izquierda

0–9 = 0–9

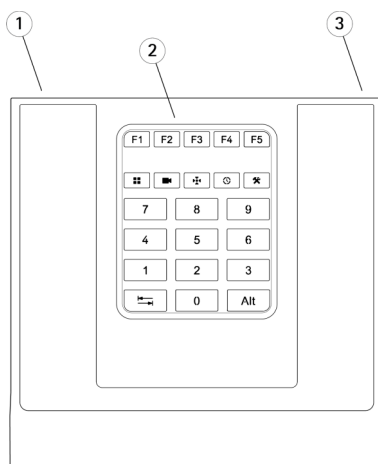

AXIS T8313 Jog dial

- 1: Puerto USB
- 2: 6 teclas totalmente personalizables
- 3: Rueda de navegación
- 4: Rueda de selección

Valores predeterminados de tecla:

- ▶: Agregar marcador
- ◀: Ir a grabación anterior
- ▶/||: Reproducir/Pausa
- ▶: Ir a siguiente grabación
- L: Mostrar/ocultar marcadores de exportación
- R: Cambiar entre vista en vivo/grabaciones

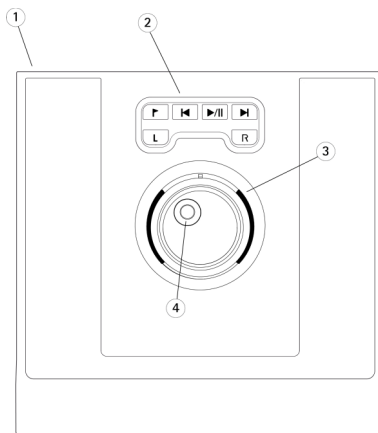

ES

Instalación del hardware

AXIS T8311 Video Surveillance Joystick, AXIS T8312 Video Surveillance Keypad y AXIS T8313 Video Surveillance Jog Dial se pueden conectar por separado o juntos como unidad utilizando el AXIS T8312 Video Surveillance Keypad como un concentrador USB. Las unidades se pueden colocar en el orden que necesite para adaptarse a sus requisitos.

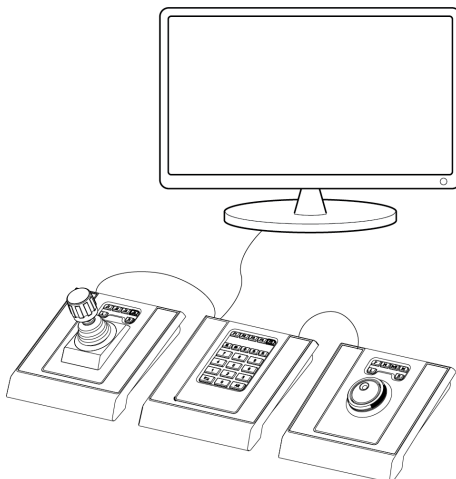

AXIS T8310 Video Surveillance Control Board

1. Conecte el cable USB a un puerto USB de su equipo.
2. Siga las instrucciones en pantalla (si procede) para instalar los controladores necesarios. El AXIS T8311 Joystick aparecerá como un controlador/dispositivo de juegos en Windows.
3. Inicie el software de aplicación compatible —por ejemplo, AXIS Camera Station—, que detectará automáticamente los dispositivos en el AXIS T8310.

Nota

El sistema debe contar con un software de aplicación compatible, p. ej. AXIS Camera Station, que pueda detectar el nuevo hardware. Consulte axis.com para obtener información sobre los sistemas compatibles.

Solución de problemas

Si experimenta problemas durante la instalación, pruebe a realizar lo siguiente:

- Reinicie el software de aplicación compatible, p. ej. AXIS Camera Station.
- Desconecte el cable USB del ordenador, espere 10 segundos y vuelva a conectar.
- Mueva el cable USB a otro puerto USB disponible en su ordenador.
- Compruebe que el sistema operativo haya identificado el joystick. Esto se puede comprobar en el administrador de dispositivos de Windows.

インストールガイド

このインストールガイドでは、AXIS T8310 Video Surveillance Control Board (ビデオ監視コントロールボード) をインストールする手順について説明しています。製品の使用の詳細については、AXIS Camera Stationのヘルプページを参照してください。

Overview (概要)

AXIS T8310 Video Surveillance Control Board (ビデオ監視コントロールボード) の3つのユニットは個別に、または1つのユニットとして同時にインストールできます。USB接続を経由して電源が供給されます。

パッケージの内容

アイテム	モデル/型/注	
ジョイスティック/ キーパッド/ジョグダ イアル	AXIS T8311/ AXIS T8312/ AXIS T8313	
USBケーブル	AXIS T8311:	別売り時は1 x 200 cmで、PC接続のみ
	AXIS T8312:	ユニット間の接続用 1 x 40 cm PC接続用 1 x 200 cm
	AXIS T8313:	1 x 40 cm 2ユニットのキーパッド接続用 1 x 80 cm

JA

ハードウェアの概要

AXIS T8310 Video Surveillance Control Board (ビデオ監視コントロールボード)

AXIS T8310 Video Surveillance Control Board

- 1: AXIS T8311 Video Surveillance Joystick (ジョイスティック)
- 2: AXIS T8312 Video Surveillance Keypad (キーパッド)
- 3: AXIS T8313 Video Surveillance (ジョグダイヤル)

注意

全ユニットの全キーは対応ソフトウェアからすべてカスタマイズ可能です。いくつかのキーにはデフォルト値があり、製品の概要とともに表示されています。

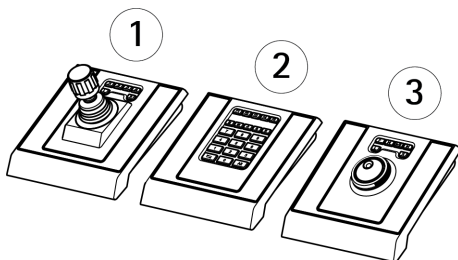

AXIS T8311 Joystick (ジョイスティック)

- 1: USBポート
- 2: 6つの全カスタマイズ可能なキー
- 3: ジョイスティック

キーのデフォルト値:

J1~J4 - デフォルトなし

L - 左マウスボタンのクリックをシミュレート

R - 右マウスボタンのクリックをシミュレート

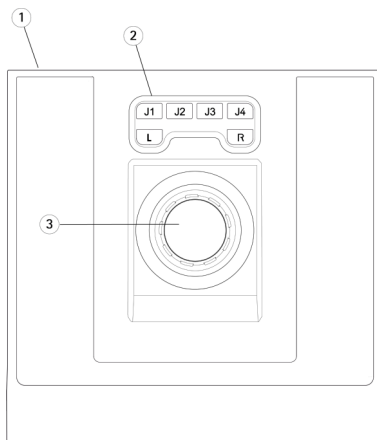

AXIS T8312 Keypad (キーパッド)

AXIS T8310 Video Surveillance Control Board

- 1: USBポート (x2)
- 2: 22の全カスタマイズ可能なキー
- 3: USBポート

キーのデフォルト値:

F1 - デフォルトなし

F2 - [ホットキー] タブを開く

F3 - デフォルトなし

F4 - [ログ] タブを開く

F5 - [設定] タブを開く

 - ビューを開く

 - 次のカメラ/ビュー

 - デフォルトなし

 - デフォルトなし

 - デフォルトなし

 - 右のタブに移動する

 + Alt = 左のタブに移動する

0-9 = 0-9

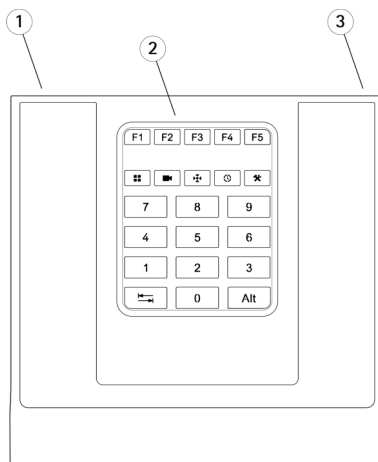



JA

AXIS T8313 Jog dial (ジョグダイヤル)

- 1: USBポート
- 2: 6つの全カスタマイズ可能なキー
- 3: シャトルホイール
- 4: ジョグホイール

キーのデフォルト値:

 - ブックマークを追加する

 - 前の録画に移動する

 - 再生する/一時停止する

 - 次の録画に移動する

L - エクスポートマーカーを表示/非表示にする

R - ライブ/録画の切り替え

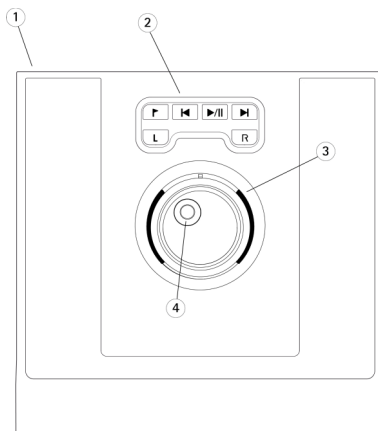

ハードウェアの設置

AXIS T8311 Video Surveillance Joystick (ジョイスティック)、AXIS T8312 Video Surveillance Keypad (キーパッド) およびAXIS T8313 Video Surveillance (ジョグダイヤル) は個別に、またはAXIS T8312 Video Surveillance Keypad (キーパッド) をUSBハブとして使用することでユニットとして同時に接続することが可能です。ユニットは必要に応じてどのような順番でも配置することができます。

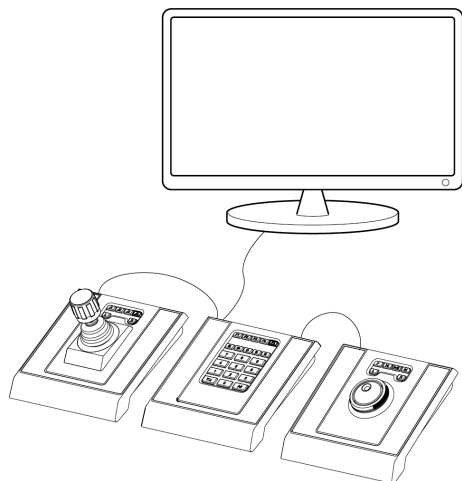

1. USBケーブルをコンピューターのUSBポートに接続します。
2. 画面の指示（該当する場合）にしたがって、必要なドライバーをインストールします。AXIS T8311 Joystick (ジョイスティック) はWindowsのゲームコントローラー/デバイスとして表示されます。
3. AXIS Camera Stationなどの対応アプリケーションソフトウェアを開きます。AXIS T8310のデバイスが自動的に読み込まれます。

注意

システムには、新しいハードウェアを検出できるAXIS Camera Stationなどの対応アプリケーションソフトウェアが必要です。対応システムの情報については、axis.comを参照してください。

トラブルシューティング

インストール中に問題が発生した場合は以下をお試してください。

- AXIS Camera Stationなどの対応アプリケーションソフトウェアを再起動します。

AXIS T8310 Video Surveillance Control Board

- USBケーブルをコンピューターから外し、10秒待ってから再接続します。
- USBケーブルをコンピューターの使用可能な別USBポートに移動します。
- オペレーティングシステムがジョイスティックを認識しているか確認します。Windowsデバイスマネージャーで確認することができます。

安装指南

本安装指南提供 AXIS T8310 视频监控控制板的安装说明。有关使用本产品的其他方面内容，请参见 AXIS Camera Station 的帮助页面。

概述

AXIS T8310 视频监控控制板的三个单元可以单独安装或安装为一个单元。通过 USB 连接进行供电。

包装内含物

项目	模型/变体/说明	
操纵杆/键盘/滚轮按钮	AXIS T8311/ AXIS T8312/ AXIS T8313	
USB 数据线	AXIS T8311:	1 x 200 cm (78.7 英寸) (单独销售时) , 仅与 PC 连接
	AXIS T8312:	1 x 40 cm (15.7 英寸) 用于连接各单元, 1 x 200 cm 用于连接 PC
	AXIS T8313:	1 x 40 cm 1 x 80 cm (31.5 英寸) 用于两个单元与键盘之间的连接

ZH

硬件概览

AXIS T8310 视频监控控制板

- 1: AXIS T8311 视频监控操纵杆
- 2: AXIS T8312 视频监控键盘
- 3: AXIS T8313 视频监控滚轮按钮

备注

单元上的键均可从支持软件上完全自定义。一些键具有与产品概述一并列出的默认值。

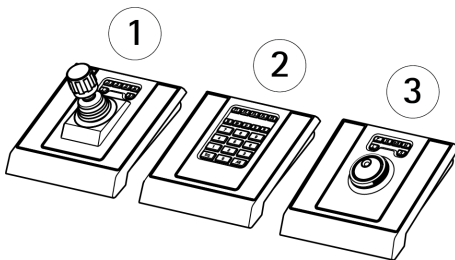

AXIS T8310 Video Surveillance Control Board

AXIS T8311 操纵杆

- 1: USB 端口
- 2: 6 个完全自定义键
- 3: 操纵杆

键默认值:

J1-J4 - 无默认

L - 模拟鼠标左键点击

R - 模拟鼠标右键点击

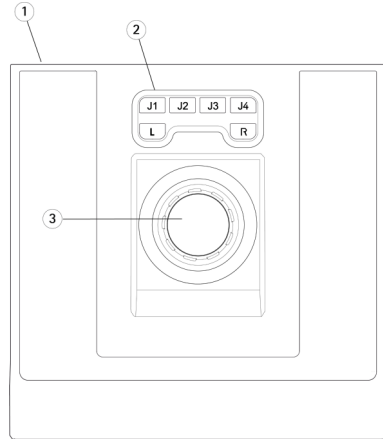

AXIS T8312 键盘

- 1: USB 端口 (x2)
- 2: 22 个完全自定义键
- 3: USB 端口

键默认值:

F1 - 无默认

F2 - 打开快捷键选项卡

F3 - 无默认

F4 - 打开日志选项卡

F5 - 打开设置选项卡

 - 打开视图

 - 下一个摄像机/视图

 - 无默认

 - 无默认

 - 无默认

 - 转至右边选项卡

 + Alt = 转至左边选项卡

0-9 = 0-9

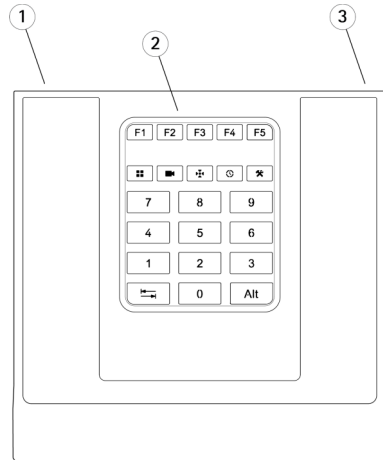

AXIS T8313 滚轮按钮

- 1: USB 端口
- 2: 6 个完全自定义键
- 3: 导航旋钮
- 4: 调节旋钮

键默认值:

- ▶ - 添加书签
- ◀ - 转至上一条记录
- ▶|| - 播放/暂停
- ▶▶ - 转至下一条记录
- L - 显示/隐藏出口标记
- R - 在现场/记录之间切换

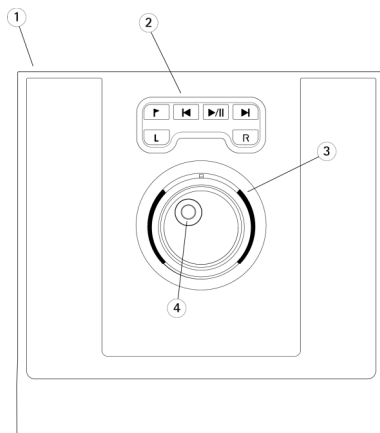

安装硬件

使用 AXIS T8312 视频监控键盘作为 USB 集线器，可以将 AXIS T8311 视频监控操纵杆、AXIS T8312 视频监控键盘和 AXIS T8313 视频监控滚轮按钮分别连接或连接为一个单元。可以将此类单元排列成不同顺序来满足你自己的要求。

ZH

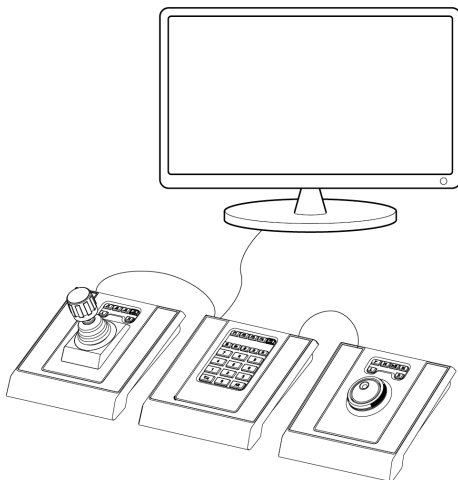

AXIS T8310 Video Surveillance Control Board

1. 在你的电脑上将 USB 数据线连接至 USB 端口。
2. （如果适用）按照屏幕上的指示安装必要的驱动程序。AXIS T8311 操纵杆将作为游戏控制器/设备出现在 Windows 中。
3. 启动支持应用软件（例如 AXIS Camera Station），它将自动检测 AXIS T8310 中的设备。

备注

系统必须安装可以检测到新硬件的支持应用软件（例如 AXIS Camera Station）。关于支持系统的信息，请浏览 axis.com。

故障排除

如果你在安装过程中遇到问题，请尝试以下方法：

- 重启支持应用软件，例如 AXIS Camera Station。
- 将 USB 数据线从电脑上断开，静候 10 秒钟，然后重新连接。
- 将 USB 数据线移到你的电脑的另一个可用 USB 端口上。
- 确认操作系统已识别操纵杆。可以在 Windows 设备管理器中就此进行检查。

