

AXIS P3301 Fixed Dome Network Camera

User Manual

About this document

This manual is intended for administrators and users of AXIS P3301 Fixed Dome Network Camera, and is applicable to firmware 5.40 and later. It includes instructions for using and managing the product on your network. Previous experience of networking will be of use when using this product. Some knowledge of UNIX or Linux-based systems may also be beneficial, for developing shell scripts and applications. Later versions of this document will be posted to the Axis website, as required. See also the product's online help, available via the web-based interface.

Legal Considerations

Video and audio surveillance can be regulated by laws that vary from country to country. Check the laws in your local region before using this product for surveillance purposes.

This product includes one (1) H.264 decoder license and one (1) AAC decoder license. To purchase further licenses, contact your reseller.

Liability

Every care has been taken in the preparation of this document. Please inform your local Axis office of any inaccuracies or omissions. Axis Communications AB cannot be held responsible for any technical or typographical errors and reserves the right to make changes to the product and manuals without prior notice. Axis Communications AB makes no warranty of any kind with regard to the material contained within this document, including, but not limited to, the implied warranties of merchantability and fitness for a particular purpose. Axis Communications AB shall not be liable nor responsible for incidental or consequential damages in connection with the furnishing, performance or use of this material. This product is only to be used for its intended purpose.

Intellectual Property Rights

Axis AB has intellectual property rights relating to technology embodied in the product described in this document. In particular, and without limitation, these intellectual property rights may include one or more of the patents listed at www.axis.com/patent.htm and one or more additional patents or pending patent applications in the US and other countries.

This product contains licensed third-party software. See the menu item "About" in the product's user interface for more information.

This product contains source code copyright Apple Computer, Inc., under the terms of Apple Public Source License 2.0 (see www.opensource.apple.com/apsl/). The source code is available from <https://developer.apple.com/bonjour/>

Equipment Modifications

This equipment must be installed and used in strict accordance with the instructions given in the user documentation. This equipment contains no user-serviceable components. Unauthorized equipment changes or modifications will invalidate all applicable regulatory certifications and approvals.

Trademark Acknowledgments

AXIS COMMUNICATIONS, AXIS, ETRAX, ARTPEC and VAPIX are registered trademarks or trademark applications of Axis AB in various jurisdictions. All other company names and products are trademarks or registered trademarks of their respective companies.

Apple, Boa, Apache, Bonjour, Ethernet, Internet Explorer, Linux, Microsoft, Mozilla, Real, SMPTE, QuickTime, UNIX, Windows, Windows Vista and WWW are registered trademarks of the respective holders. Java and all Java-based trademarks and logos are trademarks or registered trademarks of Oracle and/or its affiliates. UPnP™ is a certification mark of the UPnP™ Implementers Corporation.

Regulatory Information

Europe

 This product complies with the applicable CE marking directives and harmonized standards:

- Electromagnetic Compatibility (EMC) Directive 2004/108/EC. See *Electromagnetic Compatibility (EMC) on page 2*.
- Low Voltage (LVD) Directive 2006/95/EC. See *Safety on page 3*.

- Restrictions of Hazardous Substances (RoHS) Directive 2011/65/EU. See *Disposal and Recycling on page 3*.

A copy of the original declaration of conformity may be obtained from Axis Communications AB. See *Contact Information on page 3*.

Electromagnetic Compatibility (EMC)

This equipment has been designed and tested to fulfill applicable standards for:

- Radio frequency emission when installed according to the instructions and used in its intended environment.
- Immunity to electrical and electromagnetic phenomena when installed according to the instructions and used in its intended environment.

USA

Using an unshielded network cable (UTP) – This equipment has been tested using an unshielded network cable (UTP) and found to comply with the limits for a Class A digital device, pursuant to part 15 of the FCC Rules. These limits are designed to provide reasonable protection against harmful interference when the equipment is operated in a commercial environment. This equipment generates, uses, and can radiate radio frequency energy and, if not installed and used in accordance with the instruction manual, may cause harmful interference to radio communications. Operation of this equipment in a residential area is likely to cause harmful interference in which case the user will be required to correct the interference at his own expense.

Using a shielded network cable (STP) – This equipment has also been tested using a shielded network cable (STP) and found to comply with the limits for a Class B digital device, pursuant to part 15 of the FCC Rules. These limits are designed to provide reasonable protection against harmful interference in a residential installation. This equipment generates, uses and can radiate radio frequency energy and, if not installed and used in accordance with the instructions, may cause harmful interference to radio communications. However, there is no guarantee that interference will not occur in a particular installation. If this equipment does cause harmful interference to radio or television reception, which can be determined by turning the equipment off and on, the user is encouraged to try to correct the interference by one or more of the following measures:

- Reorient or relocate the receiving antenna.
 - Increase the separation between the equipment and receiver.
 - Connect the equipment into an outlet on a circuit different from that to which the receiver is connected.
 - Consult the dealer or an experienced radio/TV technician for help.
- To be used in a residential area or a demanding electrical environment, the product shall be connected using a shielded network cable (STP) that is properly grounded.

Canada

This Class B digital apparatus complies with Canadian ICES-003. The product shall be connected using a shielded network cable (STP) that is properly grounded.

Cet appareil numérique de la classe B est conforme à la norme NMB-003 du Canada. Le produit doit être connecté à l'aide d'un câble réseau blindé (STP) qui est correctement mis à la terre.

This product fulfills the requirements for immunity according to EN 61000-6-1 residential, commercial and light-industrial environments.

This product fulfills the requirements for immunity according to EN 61000-6-2 industrial environments.

Australia/New Zealand

This digital equipment fulfills the requirements for RF emission according to the Class B limit of AS/NZS CISPR 22. The product shall be connected using a shielded network cable (STP) that is properly grounded.

Japan

この装置は、クラスB情報技術装置です。この装置は、家庭環境で使用することを目的としていますが、この装置がラジオやテレビジョン受信機に近接して使用されると、受信障害を引き起こすことがあります。取扱説明書に従って正しい取り扱いをして下さい。本製品は、シールドネットワークケーブル(STP)を使用して接続してください。また適切に接地してください。

Korea

이 기기는 가정용(B급) 전자파적합기기로서 주로 가정에서 사용하는 것을 목적으로 하며, 모든 지역에서 사용할 수

있습니다. 적절히 접지된 STP (shielded twisted pair) 케이블을 사용하여 제품을 연결 하십시오.

Safety

Battery

The Axis product uses a 3.0 V BR/CR2032 lithium battery as the power supply for its internal real-time clock (RTC). Under normal conditions this battery will last for a minimum of five years.

Low battery power affects the operation of the RTC, causing it to reset at every power-up. When the battery needs replacing, a log message will appear in the product's server report. For more information about the server report, see the product's setup pages or contact Axis support.

The battery should not be replaced unless required, but if the battery does need replacing, contact Axis support at www.axis.com/techsup for assistance.

⚠WARNING

- Risk of explosion if the battery is incorrectly replaced.
- Replace only with an identical battery or a battery which is recommended by Axis.
- Dispose of used batteries according to local regulations or the battery manufacturer's instructions.

Disposal and Recycling

When this product has reached the end of its useful life, dispose of it according to local laws and regulations. For information about your nearest designated collection point, contact your local authority responsible for waste disposal. In accordance with local legislation, penalties may be applicable for incorrect disposal of this waste.

Europe



This symbol means that the product shall not be disposed of together with household or commercial waste. Directive 2012/19/EU on waste electrical and electronic equipment (WEEE) is applicable in the European Union member states. To prevent potential harm to human health and the environment, the product must be disposed of in an approved and environmentally safe recycling process. For information about your nearest designated collection point, contact your local authority responsible for waste disposal. Businesses should contact the product supplier for information about how to dispose of this product correctly.

This product complies with the requirements of Directive 2011/65/EU on the restriction of the use of certain hazardous substances in electrical and electronic equipment (RoHS).

China



This product complies with the requirements of the legislative act Administration on the Control of Pollution Caused by Electronic Information Products (ACPEIP).

Contact Information

Axis Communications AB
Emdalavägen 14
223 69 Lund
Sweden

Tel: +46 46 272 18 00
Fax: +46 46 13 61 30

www.axis.com

Support

Should you require any technical assistance, please contact your Axis reseller. If your questions cannot be answered immediately, your reseller will forward your queries through the appropriate channels to ensure a rapid response. If you are connected to the Internet, you can:

- download user documentation and software updates
- find answers to resolved problems in the FAQ database. Search by product, category, or phrase
- report problems to Axis support staff by logging in to your private support area
- chat with Axis support staff (selected countries only)
- visit Axis Support at www.axis.com/techsup/

Learn More!

Visit Axis learning center www.axis.com/academy/ for useful trainings, webinars, tutorials and guides.

AXIS P3301 Fixed Dome Network Camera

Table of Contents

Hardware Overview	5
Connectors and Buttons	5
LED Indicators	6
Access the Product	8
Access from a Browser	8
Access from the Internet	9
Set the Root Password	9
The Live View Page	10
Media Streams	12
How to Stream H.264	12
MJPEG	12
AXIS Media Control (AMC)	12
Alternative Methods of Accessing the Video Stream	13
Access Audio Streams	14
Set Up the Product	15
Basic Setup	15
Video and Audio	16
Video Stream	16
Stream Profiles	18
Camera Settings	18
Overlay	19
Privacy Mask	20
Audio Settings	20
Audio Clips	22
Configure the Live View Page	23
Detectors	26
Camera Tampering	26
Motion Detection	26
Audio Detection	28
Applications	29
Events	30
Convert Event Types to Action Rules	30
Set Up Action Rules	30
Add Recipients	31
Create Schedules	31
Set Up Recurrences	31
Recordings	32
Recording List	32
Continuous Recording	32
System Options	34
Security	34
Date & Time	35
Network	36
Storage	40
Ports & Devices	41
Maintenance	41
Support	42
Advanced	42
Reset to Factory Default Settings	43
Troubleshooting	44
Check the Firmware	44
Upgrade the Firmware	44
Emergency Recovery Procedure	45
Symptoms, Possible Causes and Remedial Actions	45
Technical Specifications	48
Performance Considerations	50

AXIS P3301 Fixed Dome Network Camera

Hardware Overview

Hardware Overview

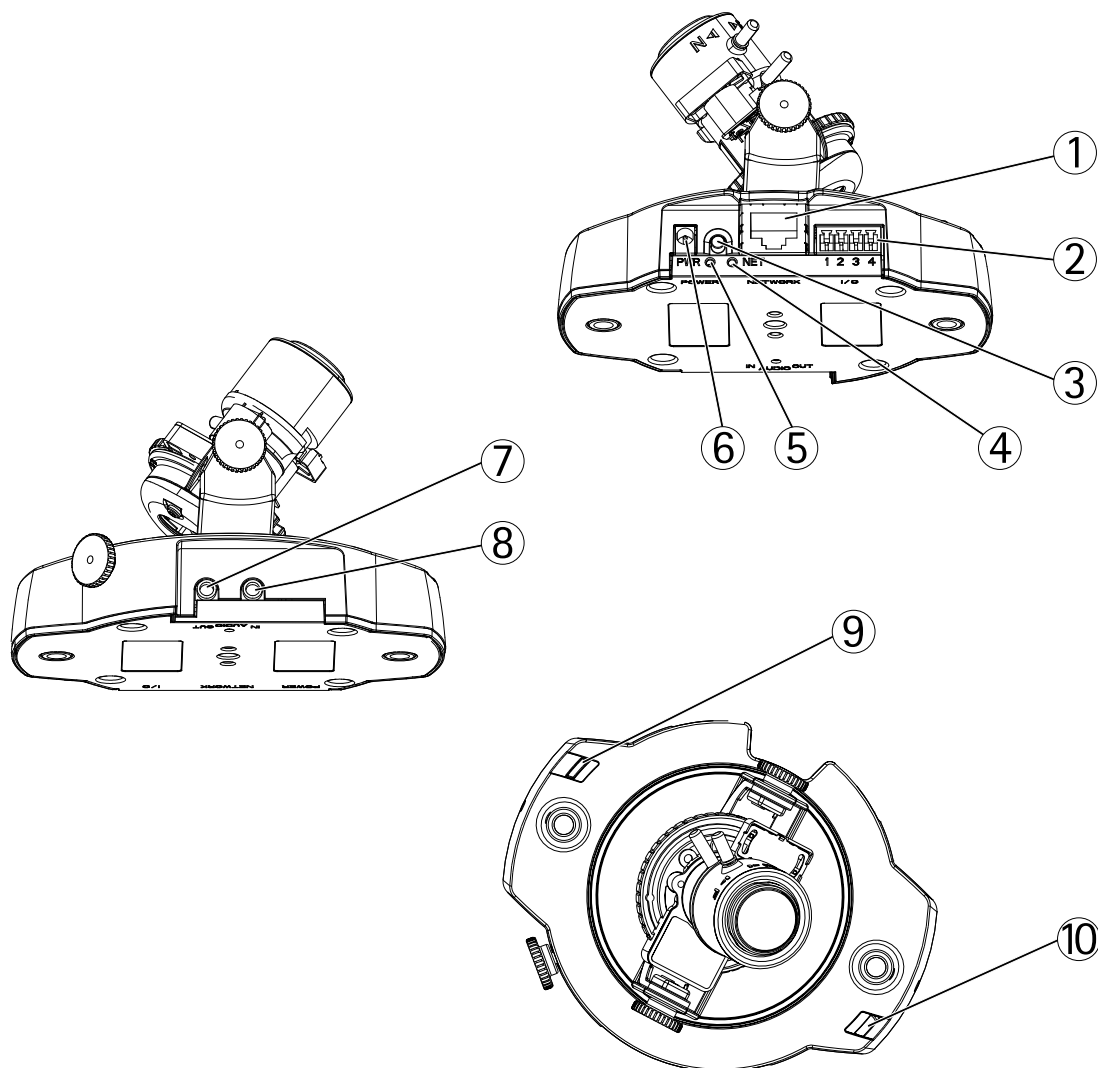

- 1 Network connector
- 2 I/O terminal connector
- 3 Control button
- 4 Network indicator LED
- 5 Power indicator LED
- 6 Power connector
- 7 Audio out
- 8 Audio in
- 9 Status indicator LED
- 10 Microphone

Connectors and Buttons

For technical specifications, see page 48.

AXIS P3301 Fixed Dome Network Camera

Hardware Overview

Network Connector

RJ45 Ethernet connector with Power over Ethernet (PoE).

NOTICE

Due to local regulations or the environmental and electrical conditions in which the product is to be used, a shielded network cable (STP) may be appropriate or required. All cables connecting the product to the network and that are routed outdoors or in demanding electrical environments shall be intended for their specific use. Make sure that the network devices are installed in accordance with the manufacturer's instructions. For information about regulatory requirements, see *Electromagnetic Compatibility (EMC) on page 2*.

I/O Connector

Use with external devices in combination with, for example, tampering alarms, motion detection, event triggering, time lapse recording and alarm notifications. In addition to the 0 V DC reference point and power (DC output), the I/O connector provides the interface to:

- **Digital output** – For connecting external devices such as relays and LEDs. Connected devices can be activated by the VAPIX® Application Programming Interface, output buttons on the Live View page or by an Action Rule. The output will show as active (shown under **System Options > Ports & Devices**) if the alarm device is activated.
- **Digital input** – An alarm input for connecting devices that can toggle between an open and closed circuit, for example: PIRs, door/window contacts, glass break detectors, etc. When a signal is received the state changes and the input becomes active (shown under **System Options > Ports & Devices**).

Power Connector

Mini DC connector. Use the supplied adapter.

Audio Connector

The Axis product has the following audio connectors:

- **Audio in (pink)** – 3.5 mm input for a mono microphone, or a line-in mono signal.
- **Audio out (green)** – 3.5 mm output for audio (line level) that can be connected to a public address (PA) system or an active speaker with a built-in amplifier. A stereo connector must be used for audio out.

For audio in, the left channel is used from a stereo signal.

Control Button

The control button is used for:

- Resetting the product to factory default settings. See *page 43*.
- Connecting to an AXIS Video Hosting System service. See *page 37*. To connect, press and hold the button for about 3 seconds until the Status LED flashes green.
- Connecting to AXIS Internet Dynamic DNS Service. See *page 37*. To connect, press and hold the button for about 3 seconds.

LED Indicators

LED	Color	Indication
Network	Green	Steady for connection to a 100 Mbit/s network. Flashes for network activity.
	Amber	Steady for connection to a 10 Mbit/s network. Flashes for network activity.
	Unlit	No network connection.

AXIS P3301 Fixed Dome Network Camera

Hardware Overview

Status	Green	Steady green for normal operation.
	Amber	Steady during startup and when restoring settings.
	Red	Slow flash for failed upgrade.
Power	Green	Normal operation.
	Amber	Flashes green/amber during firmware upgrade.

Note

- The Status LED can be configured to be unlit during normal operation. To configure, go to **Setup > System Options > Ports & Devices > LED**. See the online help for more information.
- The Status LED can be configured to flash for identifying the unit. Go to **Setup > System Options > Maintenance** .

AXIS P3301 Fixed Dome Network Camera

Access the Product

Access the Product

To install the Axis product, refer to the Installation Guide supplied with the product.

The product can be used with most operating systems and browsers. The recommended browsers are Internet Explorer with Windows, Safari with Macintosh and Firefox with other operating systems. See *Technical Specifications on page 48*.

To view streaming video in Internet Explorer, allow installation of AXIS Media Control (AMC) when prompted.

The Axis product includes one (1) H.264 decoder license for viewing video streams and one (1) AAC audio license. The licenses are automatically installed with AMC. The administrator can disable the installation of the decoders, to prevent installation of unlicensed copies.

Note

- QuickTime™ is also supported for viewing H.264 streams and for audio.
- If your computer restricts the use of additional software components, the product can be configured to use a Java applet for viewing Motion JPEG.

Access from a Browser

1. Start a browser (Internet Explorer, Firefox, Safari).
2. Enter the IP address or host name of the Axis product in the browser's Location/Address field. To access the product from a Macintosh computer (Mac OS X), click on the Bonjour tab and select the product from the drop-down list.

If you do not know the IP address, use AXIS IP Utility to locate the product on the network. For information about how to discover and assign an IP address, see the Installation and Management Software CD or the document *Assign an IP Address and Access the Video Stream* on Axis Support web at www.axis.com/techsup

3. Enter your user name and password. If this is the first time the product is accessed, the root password must first be configured. For instructions, see *Set the Root Password on page 9*.
4. The product's Live View page opens in your browser.

Note

The controls and layout of the Live View page may have been customized to meet specific installation requirements and user preferences. Consequently, some of the examples and functions featured here may differ from those displayed in your own Live View page.

AXIS P3301 Fixed Dome Network Camera

Access the Product

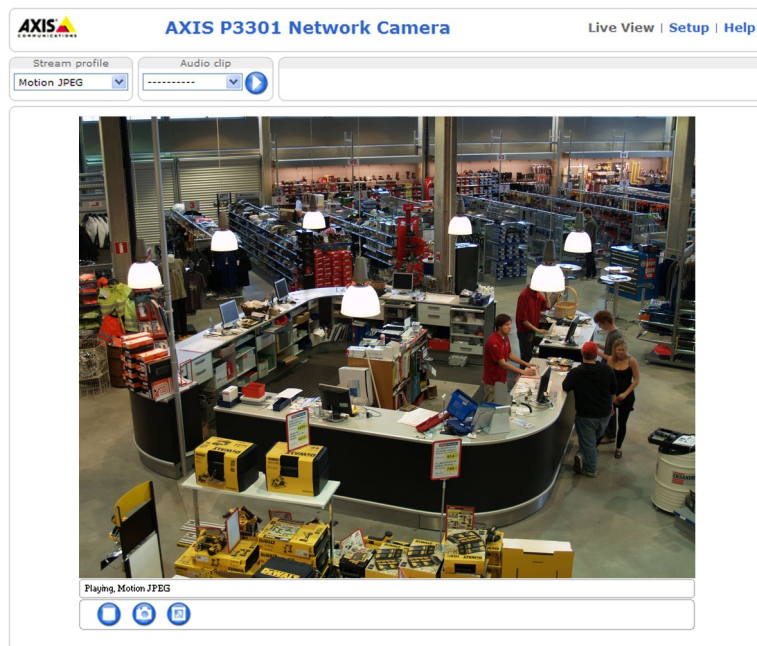

Access from the Internet

Once connected, the Axis product is accessible on your local network (LAN). To access the product from the Internet you must configure your network router to allow incoming data traffic to the product. To do this, enable the NAT-traversal feature, which will attempt to automatically configure the router to allow access to the product. This is enabled from **Setup > System Options > Network > TCP/IP Advanced**.

For more information, see *NAT traversal (port mapping) for IPv4* on page 38. See also AXIS Internet Dynamic DNS Service at www.axiscam.net

For Technical notes on this and other topics, visit the Axis Support web at www.axis.com/techsup

Set the Root Password

To access the Axis product, you must set the password for the default administrator user **root**. This is done in the **Configure Root Password** dialog, which appears when the product is accessed for the first time.

To prevent network eavesdropping, the root password can be set via an encrypted HTTPS connection, which requires an HTTPS certificate. HTTPS (Hypertext Transfer Protocol over SSL) is a protocol used to encrypt traffic between web browsers and servers. The HTTPS certificate ensures encrypted exchange of information. See *HTTPS* on page 38.

The default administrator user name **root** is permanent and cannot be deleted. If the password for **root** is lost, the product must be reset to the factory default settings. See *Reset to Factory Default Settings* on page 43.

To set the password via a standard HTTP connection, enter it directly in the dialog.

To set the password via an encrypted HTTPS connection, follow these steps:

1. Click **Create self-signed certificate**.
2. Provide the requested information and click **OK**. The certificate is created and the password can now be set securely.
3. Enter a password and then re-enter it to confirm the spelling.
4. Click **OK**. The password has now been configured.

AXIS P3301 Fixed Dome Network Camera

Access the Product

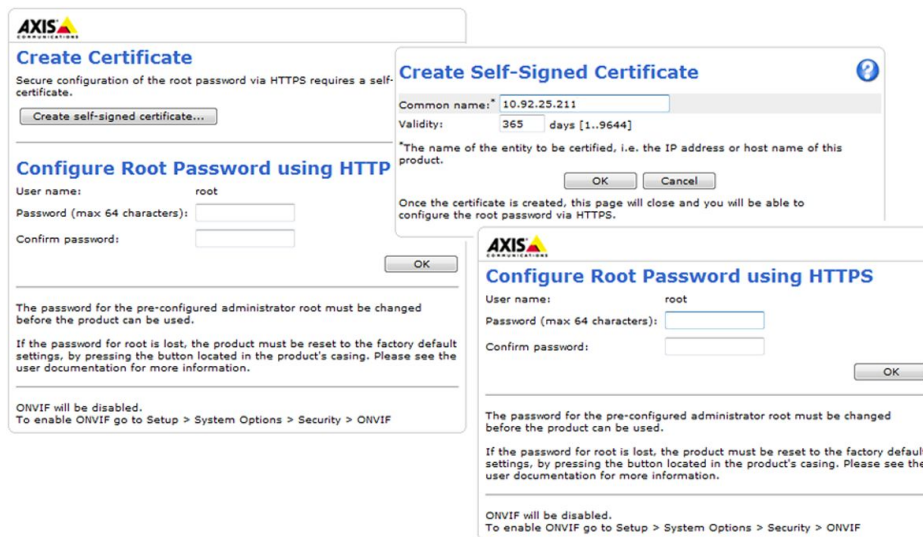

The Live View Page

The controls and layout of the Live View page may have been customized to meet specific installation requirements and user preferences. Consequently, some of the examples and functions featured here may differ from those displayed in your own Live View page. The following provides an overview of each available control.

Controls on the Live View Page



Select a stream profile for the Live View page from the **Stream Profile** drop-down list. For information about how to configure stream profiles, see [page 18](#).



Click **Pulse** to activate the product's output port for a defined period of time. For information about how to enable and configure output buttons, see [page 24](#).



Click the **Active/Inactive** buttons to manually activate and inactive the product's output port. For information about how to enable and configure output buttons, see [page 24](#).



The **Manual Trigger** button is used to trigger an action rule from the Live View page. For information about how to configure and enable the button, see .



Click **Snapshot** to save a snapshot of the video image. This button is primarily intended for use when the AXIS Media Control viewer toolbar is not available. Enable this button from **Live View Config > Action Buttons**.

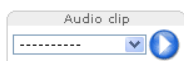





The **Audio clip** drop-down list allows you to play an audio clip from the Live View page. Select the audio clip and click the **Play** button.

AXIS Media Control viewer toolbar

The AXIS Media Control viewer toolbar is available in Internet Explorer only. See *AXIS Media Control (AMC) on page 12* for more information. The toolbar displays the following buttons:



AXIS P3301 Fixed Dome Network Camera

Access the Product

-  The **Play** button connects to the Axis product and starts playing a media stream.
-  The **Stop** button stops the media stream.
-  The **Snapshot** button takes a snapshot of the video image. The location where the image is saved can be specified in the AMC Control Panel.
-  Click the **View Full Screen** button and the video image will fill the entire screen. Press ESC (Escape) on the computer keyboard to cancel full screen view.
-  The **Record** button is used to record the current video stream. The location where the recording is saved can be specified in the AMC Control Panel. Enable this button from **Live View Config > Viewer Settings**.

AMC Audio Controls

AMC audio buttons control the speakers and microphone connected to the client computer. The buttons are only visible when audio is enabled.

-  **Speaker button** – Click to turn the speakers on or off.
-  **Microphone button** – Click to mute or unmute the microphone. In *Simplex - speaker only mode*, the **Microphone** and **Talk** buttons must both be active to send audio to the Axis product. Click either button to stop audio transmission.



Use the slider to control the volume of the speakers and the microphone.



Half-duplex mode

The **Talk/Listen** button is used to switch between sending and receiving audio. The button can be configured from the Audio tab in the AMC Control panel:

- **Push-To-Talk mode:** Click and hold the button to talk/send. Release the button to listen.
- **Toggle mode:** Click once to switch between talking and listening.

Simplex - speaker only mode

To send audio, the **Talk** and **Microphone** buttons must both be active. Click either button to stop audio transmission.

AXIS P3301 Fixed Dome Network Camera

Media Streams

Media Streams

The Axis product provides several audio and video stream formats. Your requirements and the properties of your network will determine the type you use.

The Live View page in the product provides access to H.264 and Motion JPEG video streams, audio streams and to the list of available stream profiles. Other applications and clients can access video and audio streams directly, without going via the Live View page.

How to Stream H.264

H.264 can, without compromising image quality, reduce the size of a digital video file by more than 80% compared with the Motion JPEG format and as much as 50% more than the MPEG-4 standard. This means that much less network bandwidth and storage space are required for a video file. Or seen another way, much higher video quality can be achieved for a given bit rate.

Deciding which combination of protocols and methods to use depends on your viewing requirements, and on the properties of your network. The available options in AXIS Media Control are:

Unicast RTP	This unicast method (RTP over UDP) is used for live unicast video, especially when it is important to always have an up-to-date video stream, even if some frames are dropped.	Unicasting is used for video-on-demand transmission so that there is no video traffic on the network until a client connects and requests the stream. Note that there are a maximum of 20 simultaneous unicast connections.
RTP over RTSP	This unicast method (RTP tunneled over RTSP) is useful as it is relatively simple to configure firewalls to allow RTSP traffic.	
RTP over RTSP over HTTP	This unicast method can be used to traverse firewalls. Firewalls are commonly configured to allow the HTTP protocol, thus allowing RTP to be tunneled.	
Multicast RTP	This method (RTP over UDP) should be used for live multicast video. The video stream is always up-to-date, even if some frames are dropped. Multicasting provides the most efficient usage of bandwidth when there are large numbers of clients viewing simultaneously. A multicast cannot however, pass a network router unless the router is configured to allow this. It is not possible to multicast over the Internet, for example. Note also that all multicast viewers count as one unicast viewer in the maximum total of 20 simultaneous connections.	

AXIS Media Control negotiates with the Axis product to determine the transport protocol to use. The order of priority, listed in the AMC Control Panel, can be changed and the options disabled, to suit specific requirements.

Note

H.264 is licensed technology. The Axis product includes one H.264 viewing client license. Installing additional unlicensed copies of the client is prohibited. To purchase additional licenses, contact your Axis reseller.

MJPEG

This format uses standard JPEG still images for the video stream. These images are then displayed and updated at a rate sufficient to create a stream that shows constantly updated motion.

The Motion JPEG stream uses considerable amounts of bandwidth, but provides excellent image quality and access to every image contained in the stream. The recommended method of accessing Motion JPEG live video from the Axis product is to use the AXIS Media Control in Internet Explorer in Windows.

AXIS Media Control (AMC)

AXIS Media Control (AMC) in Internet Explorer in Windows is the recommended method of accessing live video from the Axis product.

AXIS P3301 Fixed Dome Network Camera

Media Streams

The AMC Control Panel can be used to configure various video and audio settings. Please see the AXIS Media Control User's Manual for more information.

The AMC Control Panel is automatically installed on first use, after which it can be configured. Open the AMC Control Panel from:

- Windows Control Panel (from the Start screen or Start menu)
- Alternatively, right-click the video image in Internet Explorer and click **Settings**.

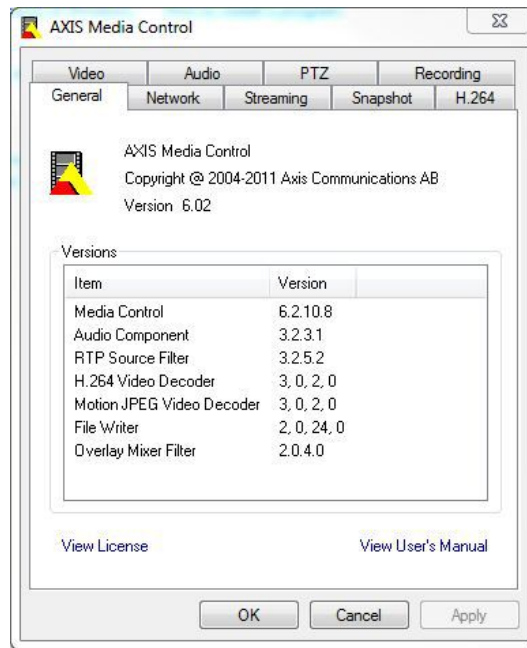

Alternative Methods of Accessing the Video Stream

You can also access video and images from the Axis product in the following ways:

- **Motion JPEG server push** (if supported by the client, Firefox, for example). This option maintains an open HTTP connection to the browser and sends data as and when required, for as long as required.
- **Still JPEG images in a browser**. Enter the path `http://<ip>/axis-cgi/jpg/image.cgi`
- **Windows Media Player**. This requires AXIS Media Control and the H.264 decoder to be installed. The following paths can be used:
 - Unicast via RTP: `axrtpu://<ip>/axis-media/media.amp`
 - Unicast via RTSP: `axrtsp://<ip>/axis-media/media.amp`
 - Unicast via RTSP, tunneled via HTTP: `axrtsphhttp://<ip>/axis-media/media.amp`
 - Multicast: `axrtpm://<ip>/axis-media/media.amp`
- **QuickTime™**. The following paths can be used:
 - `rtsp://<ip>/axis-media/media.amp`
 - `rtsp://<ip>/axis-media/media.3gp`

AXIS P3301 Fixed Dome Network Camera

Media Streams

Note

- <ip>= IP address
- The Axis product supports QuickTime 6.5.1 and later.
- QuickTime may add latency to the video stream.
- It may be possible to use other players to view the H.264 stream using the paths above, although Axis does not guarantee this.

Access Audio Streams

The Live View page provides access to audio through AXIS Media Control; in addition audio can be accessed in the following ways:

- **VAPIX® Application Programming Interface (API)** For more information, visit www.axis.com/developer
- **Windows Media Player** supports simplex audio. The following paths can be used:
 - Unicast via RTP: `axrtpu://<ip>/axis-media/media.amp`
 - Unicast via RTSP: `axrtsp://<ip>/axis-media/media.amp`
 - Unicast via RTSP, tunneled via HTTP: `axrtsphhttp://<ip>/axis-media/media.amp`
 - Multicast: `axrtpm://<ip>/axis-media/media.amp`
- **QuickTime™** supports G.711 and AAC audio encoding. The following paths can be used:
 - `rtsp://<ip>/axis-media/media.amp`
 - `rtsp://<ip>/axis-media/media.3gp`
- The **Java applet** supports simplex audio with G.711 encoding.

AXIS P3301 Fixed Dome Network Camera

Set Up the Product

Set Up the Product

The Axis product can be configured by users with administrator or operator rights. To open the product's Setup pages, click **Setup** in the top right-hand corner of the Live View page.

- **Administrators** have unrestricted access to all settings.
- **Operators** have access to all settings except System Options

See also the online help  .

Basic Setup

Basic Setup provides shortcuts to the settings that should be made before using the Axis product:

1. **Users.** See *page 34*.
2. **TCP/IP.** See *page 36*.
3. **Date & Time.** See *page 35*.
4. **Video Stream.** See *page 16*.
5. **Focus.** See *page 15*.
6. **Audio Settings.** See *page 20*.

The Basic Setup menu can be disabled from **System Options > Security > Users**.

Focus Adjustment

The focus can be adjusted under **Basic Setup > Focus**. Follow the on-screen instructions to adjust the focus. For further information about focus, refer to the product's Installation Guide.

AXIS P3301 Fixed Dome Network Camera

Video and Audio

Video and Audio

The video and audio settings can be used to optimize video and audio quality. You can configure the following:

- Video stream settings. See *page 16*.
- Stream profiles. See *page 18*.
- Camera settings. See *page 18*.
- Overlay image. See *page 19*.
- Privacy mask. See *page 20*.
- Audio settings. See *page 20*.
- Audio clips. See *page 22*.

Video Stream

You can define the following video stream settings from **Video & Audio > Video Stream**:

- Image. See *page 16*.
- Audio. See *page 20*.
- H.264. See *page 17*.
- MJPEG. See *page 17*.

The screenshot shows the 'Video Stream Settings' configuration page. On the left is a navigation menu with categories: Basic Setup, Video & Audio (expanded), Live View Config, Detectors, Applications, Events, Recordings, System Options, and About. Under 'Video & Audio', the following options are listed: Video Stream (selected), Stream Profiles, Camera Settings, Overlay Image, Privacy Mask, Audio Settings, and Audio Clips. The main content area is titled 'Video Stream Settings' and has four tabs: Image (selected), Audio, H.264, and MJPEG. The 'Image Appearance' section includes: Resolution (640x480 (4:3) pixels), Compression (30 [0..100]), a checkbox for 'Mirror image', Rotate image (0 degrees), and Color setting (Color). The 'Video Stream' section includes: Maximum frame rate (Unlimited selected, Limited to [] [1..30] fps per viewer). The 'Overlay Settings' section includes: checkboxes for 'Include overlay image at the coordinates: X [0] [0..] Y [0] [0..]', 'Include date', and 'Include time'; a checkbox for 'Include text:'; Text color (white), Text background color (black), and 'Place text/date/time at [top] of image'. At the bottom is a 'Preview' section with 'View image stream while configuring.' (checked), Video format (MJPEG), and an 'Open...' button. 'Save' and 'Reset' buttons are at the very bottom.

Image

The default image settings can be configured under **Video & Audio > Video Stream**. Select the **Image** tab.

The following settings are available:

- **Resolution.** Select the default resolution.

AXIS P3301 Fixed Dome Network Camera

Video and Audio

- Select **Aspect ratio correction** to improve the appearance of images in the browser when the video stream has a different aspect ratio. Pixels comprising the image are rearranged so as to provide a more accurate representation of the image.
- **Compression**. The compression level affects the image quality, bandwidth and file size of saved images; the lower the compression, the higher the image quality with higher bandwidth requirements and larger file sizes.
- **Mirror image**. If required, the image can be mirrored.
- **Rotate image**. If required, the image can be rotated.
- **Maximum frame rate**. To avoid bandwidth problems, the frame rate allowed to each viewer can be **Limited** to a fixed amount. Alternatively, the frame rate can be set as **Unlimited**, which means the Axis product always delivers the highest frame rate possible under the current conditions.
- **Overlay settings**. See *Overlay* on page 19.

Click **Save** to apply the new settings.

H.264

H.264, also known as MPEG-4 Part 10/AVC, is a video compression standard that provides high quality video streams at low bit rates. An H.264 video stream consists of different types of frames such as I-frames and P-frames. An I-frame is a complete image whereas P-frames only contain the differences from previous frames.

The H.264 stream settings can be configured from the **Video & Audio > Video Stream** page. Select the **H.264** tab. The settings defined in this page will apply to all H.264 streams that do not use a stream profile.

The **GOV length** is the number of frames between two consecutive I-frames. Increasing the GOV length may save considerably on bandwidth requirements in some cases, but may also have an adverse affect on image quality.

The Axis product supports the following **H.264** profiles:

- **Baseline**. The Baseline profile is recommended for clients that don't support CABAC entropy coding.

The bit rate can be set as **Variable bit rate (VBR)** or **Constant bit rate (CBR)**. VBR adjusts the bit rate according to the image complexity, using up more bandwidth for increased activity in the image, and less for lower image activity. When the activity in the scene increases, the bit rate would usually increase as well. If there is a surplus in bandwidth, this may not be an issue and selecting **Variable bit rate (VBR)** will be sufficient. But if bandwidth is limited, it is recommended to control the bit rate by selecting **Constant bit rate (CBR)**. When the activity in the scene increases, VBR adjusts the bit rate according to the complexity, using up more bandwidth for increased activity in the scene, and less for lower scene activity. CBR allows you to set a target bit rate that limits the bandwidth consumption.

The CBR target bit rate works like the ceiling of a tent. It limits the bit rate, while maintaining some flexibility. The bit rate may bounce up and down within the set target but when it nears the set target value, the limitation kicks in. However, because CBR will always prioritize a continuous video stream, it allows temporary overshoots from the target bit rate. Because setting a target value prevents the bit rate from increasing, frame rate and image quality are affected negatively. To partly compensate for this, select which variable shall be prioritized, frame rate or image quality. Not setting a priority means that frame rate and image quality are equally affected.

The current bit rate can be set to appear as text overlay. Under **Overlay Settings**, select **Include text** and enter the modifier #b in the field.

To apply the settings, click **Save**.

MJPEG

Sometimes the image size is large due to low light or complex scenery. Adjusting the maximum frame size helps to control the bandwidth and storage used by the Motion JPEG video stream in these situations. Setting the frame size to the **Default** setting provides consistently good image quality at the expense of increased bandwidth and storage usage in low light. Limiting the frame size optimizes bandwidth and storage usage, but may give poor image quality. To prevent increased bandwidth and storage usage, the maximum frame size should be set to an optimal value.

AXIS P3301 Fixed Dome Network Camera

Video and Audio

Stream Profiles

A stream profile is a set of predefined stream settings including resolution, compression, frame rate and overlay settings. Stream profiles can be used:

- When setting up recording using action rules. See *Events* on page 30.
- When setting up continuous recording. See *Continuous Recording* on page 32.
- In the Live View page – select the stream profile from the **Stream profile** drop-down list.

For quick setup, use one of the predefined stream profiles. Each predefined profile has a descriptive name, indicating its purpose. If required, the predefined stream profiles can be modified and new customized stream profiles can be created.

To create a new profile or modify an existing profile, go to **Setup > Video & Audio > Stream Profiles**.

To select a default stream profile for the Live View page, go to **Setup > Live View Config**.

Camera Settings

The **Video & Audio > Camera Settings** page provides access to advanced image settings for the Axis product.

Image Appearance

Increasing the **Color** level increases the color saturation. The value 100 gives maximum color saturation. The value 0 gives a black and white image.

The image **Brightness** can be adjusted in the range 0–100, where a higher value produces a brighter image.

Increasing the **Sharpness** can increase bandwidth usage. A sharper image might increase image noise especially in low light conditions. A lower setting reduces image noise, but the whole image will appear less sharp.

The **Contrast** changes the relative difference between light and dark. It can be adjusted using the slider.

White Balance

White balance is used to make colors in the image appear the same regardless of the color temperature of the light source. The Axis product can be set to automatically identify the light source and compensate for its color. Alternatively, select the type of light source from the drop-down list. For a description of each available setting, see the online help .

Wide Dynamic Range

Wide dynamic range (**Dynamic Contrast**) can improve the exposure when there is a considerable contrast between light and dark areas in the image. Enable WDR in intense backlight conditions. Disable WDR in low light conditions for optimal exposure.

Note

This setting is only possible when using automatic exposure control.

Exposure Settings

Configure the exposure settings to suit the image quality requirements in relation to lighting, frame rate and bandwidth considerations.

Exposure value – Click in the bar to fine-tune the exposure.

Exposure control – These settings is used to adapt to the amount of light used. **Automatic** is the default settings can be used in most situations. The shutter speed is automatically set to produce optimum image quality. **Flicker-free 50 or 60 Hz** is used to remove flicker which can be caused by fluorescent and other light sources. The **Hold current** option locks the current exposure settings.

Enable Backlight compensation – Enable this option if a bright spot of light, for example a light bulb, causes other areas in the image to appear too dark.

AXIS P3301 Fixed Dome Network Camera

Video and Audio

Exposure zones – This settings determines which part of the image is used to calculate the exposure. For most situations, the **Auto** setting can be used. For particular requirement, select a predefined area.

Exposure priority – When **Motion** is prioritized and maximum **Shutter** time is set to a small value, motion blur in the image is minimized. This can be useful for recognition of moving objects such as people and vehicles. However, prioritizing motion may cause an increase in image noise, especially in low light situations. When **Low noise** is prioritized and **Gain** is set to a small value, image noise is minimized. The file size is reduced, which can be useful if storage space or bandwidth is limited. However, prioritizing low noise may result in a very dark image, especially in low light situations.

Iris adjustment

Select **Enable automatic iris adjustment** to automatically compensate for changing light conditions. This option is not available if a fixed iris is used.

Overlay

Overlays are used to provide extra information, for example for forensic video analysis or during product installation and configuration. Overlays are superimposed over the video stream.

An overlay text can display the current date and time, or a text string. When using a text string, modifiers can be used to display information such as the current bit rate or the current frame rate. For information about available modifiers, see *File Naming & Date/Time Formats* in the online help .

To enable overlays:

1. Go to **Video & Audio > Video Stream** and select the **Image** tab.
2. To include an overlay image, select **Include overlay image at the coordinates**. The overlay image must first be uploaded to the Axis product, see *Overlay Image*.
3. To include date and time, select **Include date** and **Include time**.
4. To include a text string, select **Include text** and enter the text in the field. Modifiers can be used, see *File Naming & Date/Time Formats* in the online help .
5. Define text overlay characteristics in the relevant fields.
6. Click **Save**.

To modify the date and time format, go to **System Options > Date & Time**. See *Date & Time* on page 35.

Overlay Image

An overlay image is a static image superimposed over the video stream. The image, for example a company logo, is used to provide extra information or to mask a part of the image.

For more information about privacy masks, see *Privacy Mask* on page 20.

To use an overlay image, the image must first be uploaded to the Axis product. The uploaded image should be a Windows 24-bit BMP image with maximum 250 colors. The image width and height, in pixels, must be exactly divisible by 4 and cannot be larger than the maximum image resolution. If combining text and image overlays, take into consideration that the text overlay occupies 16 or 32 pixels in height (depending on the resolution) and has the same width as the video image.

To automatically scale the image to the resolution used by the Axis product, select the option **Scale with resolution** from the **Transparency Settings** page which is displayed when uploading in the image.

To upload an overlay image:

1. Go to **Video & Audio > Overlay Image**.
2. Click **Browse** and browse to the file.

AXIS P3301 Fixed Dome Network Camera

Video and Audio

3. Click **Upload**.
4. The **Transparency Settings** page is now displayed:
 - To make a color in the overlay image transparent, select **Use transparency** and enter the RGB hexadecimal value for the color. Example: To make white transparent, enter #FFFFFF.
 - To scale the image automatically, select **Scale with resolution**. The image will be scaled down to fit the resolution used by the Axis product.
5. Click **Save**.

To select the image to use as overlay:

1. Go to **Video & Audio > Overlay Image**.
2. Select the image to use from the **Use overlay image** list and click **Save**.

To display the overlay image:

1. Go to **Video & Audio > Video Stream** and select the **Image** tab.
2. Under **Overlay Settings**, select **Include overlay image at the coordinates**.
3. To control the image's position, enter the X and Y coordinates. The X=0 and Y=0 position is the top left corner. If a part of the image is positioned outside the video image, the overlay image will be moved so that the whole image is visible.
4. Click **Save**.

Privacy Mask

A privacy mask is a user-defined area that prevent users from viewing parts of the monitored area. Privacy masks appear as blocks of solid color and are applied on the video stream. Privacy masks cannot be bypassed using the VAPIX® application programming interface (API).

The Privacy Mask List (**Video & Audio > Privacy Mask**) shows all the masks that are currently configured in the Axis product and indicates if they are enabled.

You can add a new mask, re-size the mask with the mouse, choose a color for the mask, and give the mask a name.

For more information, see the online help 

Important

Adding many privacy masks may affect the product's performance.

Audio Settings

The audio functionality for each video stream is enabled under **Video & Audio > Video Stream > Audio**.

Audio Modes

The Axis product supports the following audio modes:

Full duplex – Simultaneous two-way audio allowing the Axis product to transmit and receive audio at the same time. There is no echo cancellation; if feedback loops appear, try moving the microphone or the speaker.

Half-duplex – Audio can be transmitted to and from the Axis product but only in one direction at a time. To transmit audio using the Live View page, use the **Talk** and **Listen** buttons, see *AMC Audio Controls on page 11*.

AXIS P3301 Fixed Dome Network Camera

Video and Audio

Simplex — Network Camera speaker only – Audio is transmitted from a client to the Axis product and can be played by a speaker connected to the product. To transmit audio using the Live View page, the **Talk** and **Microphone** buttons must both be active, see *AMC Audio Controls* on page 11.

Simplex — Network Camera microphone only – Audio captured by the product microphone is transmitted from the Axis product to one or more clients.

To set the audio mode, go to **Video & Audio > Audio Settings** and select the desired mode from the **Audio mode** drop-down list.

Audio Input

An external microphone or a line source can be connected to the Audio-in connector. Configure the audio input settings under **Video & Audio > Audio Settings**.

Note

The internal microphone is used by default; the external microphone is used when connected. It is possible to disable the internal microphone by connecting a plug to the mic input.

Select **Microphone** to use an external microphone or **Line** to use a Line in device, e.g. an audio mixer for multiple microphones or a microphone with a built-in amplifier, as audio source.

To use a professional microphone requiring 48 V phantom power, you need an external power supply and a balanced-unbalanced converter (audio transformer) in between.

The **Microphone power** option provides DC power for an external microphone. Microphone power should only be used with microphones that have no battery and when using the internal microphone. This setting should not be enabled when using a dynamic or battery powered microphone. Microphone power will not harm the microphone; if you are uncertain, try switching it off and on. To use a professional microphone requiring 48 V phantom power, you need an external power supply and a balanced-unbalanced converter (audio transformer) in between.

Use the **Input gain** to control the volume (dB Full Scale) of the audio input. If the sound is too low, choose a higher dB, to amplify the sound. If the sound is too high, choose a lower dB. The **Level** bar gives a visual representation of the audio signal level in dB relative to the full-scale input level.

- Green – the signal is at a good level.
- Yellow – the signal is becoming distorted.
- Red – the signal is distorted.

Use the **Encoding** option to select digital audio encoding format.

- **AAC** requires a license for both encoding and decoding. AAC is the least complicated and most widely used codec. If achieving the best possible audio quality is a priority, AAC is the recommended codec to use. An AAC license is included in the Axis product.
- **G711** is an unlicensed standard codec that is useful when integrating audio into a VoIP system
- **G726** is an unlicensed speech codec that is most commonly used within the security industry.

Note

If recording audio to edge storage, such as a network share, use AAC encoding.

The **Sample rate** defines the number of times per second the sound is sampled. A higher sample rate will provide better audio quality, but also requires a greater bandwidth.

Set the required **Bit rate** depending on the selected encoding. A higher bit rate will give better audio quality. A lower bit rate may have latency or delay, but will require less bandwidth.

For more information about these settings, please see the online help .

AXIS P3301 Fixed Dome Network Camera

Video and Audio

Audio Output

An external speaker can be connected to the Audio-out connector (a built-in amplifier is required for this). The output can be connected to another amplifier with speakers. A stereo connector must be used for the audio out.

Configure the audio output settings under **Video & Audio > Audio Settings**.

Output gain – Control the volume (dB Full Scale) of the line audio output. If the sound is too low, choose a higher dB. If the sound is too high, choose a lower dB.

Audio Clips

An audio clip is a sound file that can be played when events occur or directly from the **Live View** page. The audio clip must first be uploaded to the Axis product or recorded by a microphone connected to the product.

To add, download, modify or remove audio clips, go to **Video & Audio > Audio Clips**. For more information see the online help .

To configure the Axis product to play audio clips when an event occurs, an action rule must be set up. For more information, see *Events on page 30*.

Note

Audio clips cannot be used if the product's audio functionality is enabled. The audio functionality is enabled on the **Audio** tab under **Video & Audio > Video Stream**.

AXIS P3301 Fixed Dome Network Camera

Configure the Live View Page

Configure the Live View Page

You can customize the Live View page and alter it to suit your requirements. It is possible to define the following features of the Live View page.

- Stream Profile. See *page 18*.
- Default Viewer for Browser. See *page 23*.
- Viewer Settings. See *page 24*.
- Action Buttons. These are the buttons described in *Controls on the Live View Page on page 10*.
- User Defined Links. See *page 24*.
- Output Buttons. See *page 24*.

The screenshot shows the 'Live View Layout' configuration page. On the left is a navigation menu with options: Basic Setup, Video & Audio, Live View Config Layout (selected), Detectors, Applications, Events, Recordings, System Options, and About. The main content area is titled 'Live View Layout' and contains several sections:

- Stream Profile:** Stream profile: Motion JPEG (dropdown). Show stream profile selection.
- Default Viewer:** Windows Internet Explorer: AMC (ActiveX) (dropdown). Other Browsers: Server push (dropdown). **Note:** QuickTime is only used with H.264. Motion JPEG will be shown with AMC in Windows Internet Explorer and with server push in other browsers.
- Viewer Settings:** Show viewer toolbar. Enable H.264 decoder installation. Enable recording button.
- Action Buttons:** Show manual trigger button. Show snapshot button. Show audio clip section.
- User Defined Links:** Four entries for custom links. Each has a 'Show custom link' checkbox, a 'Name' field (all set to 'Custom link 1-4'), and a 'Use as' section with radio buttons for 'cgi link' (selected) and 'web link'. Each has a 'URL' field (all set to 'http://').
- Output Buttons:** Output 1: ----- (dropdown). Save and Reset buttons.

Default Viewer for Browsers

From Live View Config > Default Viewer select the default method for viewing video images in your browser. The product attempts to show the video images in the selected video format and viewer. If this is not possible, the product overrides the settings and selects the best available combination.

AXIS P3301 Fixed Dome Network Camera

Configure the Live View Page

Browser	Viewer	Description
Windows Internet Explorer	AMC	Recommended viewer in Internet Explorer (H.264/Motion JPEG).
	QuickTime	H.264.
	Java applet	A slower imaging alternative to AMC (Motion JPEG). Requires one of the following installed on the client: <ul style="list-style-type: none">• JVM (J2SE) 1.4.2 or higher.• JRE (J2SE) 5.0 or higher.
	Still image	Displays still images only. Click the Refresh button in your browser to view a new image.
Other browsers	Server Push	Recommended viewer for other browsers (Motion JPEG).
	QuickTime	H.264.
	Java applet	A slower imaging alternative to Server Push (Motion JPEG only).
	Still image	Displays still images only. Click the Refresh button in your browser to view a new image.

For more information, please see the online help .

Viewer Settings

To configure options for the viewer, go to **Live View Config > Viewer Settings**.

- Select **Show viewer toolbar** to display the AXIS Media Control (AMC) or the QuickTime viewer toolbar under the video image in your browser.
- **H.264 decoder installation**. The administrator can disable installation of the H.264 decoder included with AXIS Media Control. This is used to prevent installation of unlicensed copies. Further decoder licenses can be purchased from your Axis reseller.
- Select **Enable recording button** to enable recording from the Live View page. This button is available when using the AMC viewer. The recordings are saved to the location specified in the AMC Control Panel. See *AXIS Media Control (AMC) on page 12*.

User Defined Links

To display user-defined links in the Live View page, select the **Show custom link** option, give the link a name and then enter the URL to link to. When defining a web link do not remove the 'http://' from the URL address. Custom links can be used to run scripts or activate external devices connected to the product, or they can link to a web page. Custom links defined as cgi links will run the script in the background, in a hidden frame. Defining the link as a web link will open the link in a new window.

Output Buttons

External I/O devices connected to the Axis product's output ports can be controlled directly from the Live View page.

To display output buttons in the Live View page:

1. Go to **Setup > Live View Config**.
2. Under **Output Buttons**, select the type of control to use:
 - **Pulse** activates the output for a defined period of time. The pulse time can be set from 1/100 second to 60 seconds.
 - **Active/Inactive** displays two buttons, one for each action.

To configure the active and inactive states, go to **System Options > Ports & Devices > I/O Ports** and set the port's **Normal state**.

AXIS P3301 Fixed Dome Network Camera

Configure the Live View Page

For more information about I/O ports, see *I/O Ports on page 41*.

AXIS P3301 Fixed Dome Network Camera

Detectors

Detectors

Camera Tampering

Camera Tampering can generate an alarm whenever the camera is repositioned, or when the lens is covered, sprayed or severely defocused. To send an alarm, for example an email, an action rule must be set up.

To configure tampering:

1. Go to **Detectors > Camera Tampering**.
2. Set the **Minimum duration**, that is, the time that must elapse before an alarm is generated. Increase time to prevent false alarms for known conditions that affect the image.
3. Select **Alarm for dark images** if an alarm should be generated if lights are dimmed or turned off, or if the lens is sprayed, covered, or rendered severely out of focus.
4. Click **Save**.

To configure the product to send an alarm when tampering occurs:

1. Go to **Events > Action Rules**.
2. Click **Add** to set up a new action rule.
3. Enter a **Name** for the action rule.
4. Under **Condition**, select **Detectors** from the **Trigger** list.
5. Select **Tampering** from the list of detectors.
6. Optionally, select a schedule and set additional conditions.
7. Select the action. To send an email, select **Send Notification** and select a **Recipient** from the list of defined recipients.

Note

The **While the rule is active** option under **Duration** cannot be used with camera tampering, since camera tampering does not have a duration and once it has been triggered it will not automatically return to its untriggered state.

For more information on actions rules, see *Events on page 30*.

Motion Detection

Motion detection is used to generate an alarm whenever movement starts or stops in the camera view.

Motion detection is configured by defining up to 10 Include and Exclude windows:

- **Include windows** – define areas where motion should be detected
- **Exclude windows** – define areas within an Include window that should be ignored (areas outside Include windows are automatically ignored).

For instructions, see *Set Up Motion Detection Windows on page 27*.

To control the number of motion detection alarms, the parameters **Object Size**, **History** and **Sensitivity** can be adjusted. See *Motion Detection Parameters on page 27*.

Once motion detection windows are configured, the Axis product can be configured to perform actions when motion is detected. Possible actions include uploading images and start recording. For more information, see *Set Up Action Rules on page 30*.

AXIS P3301 Fixed Dome Network Camera

Detectors

Note

- Using the motion detection feature may decrease the product's overall performance.
- The position of the Motion Detection Window is relative to the orientation of the Camera. Changing the orientation of the camera will also change the position of the Motion Detection Window.

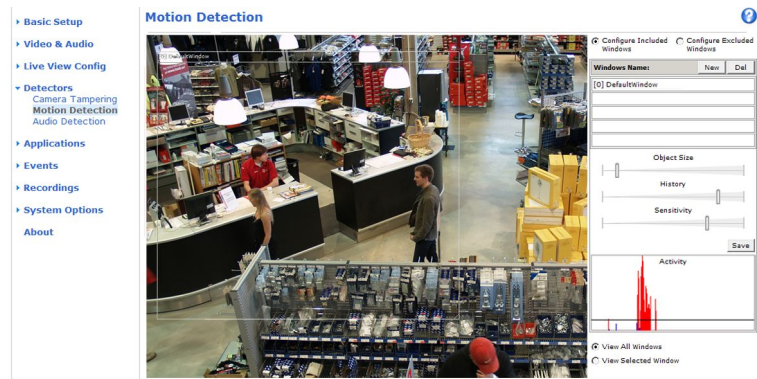

Set Up Motion Detection Windows

To set up a motion detection Include Window, follow these instructions:

1. Go to **Detectors > Motion Detection**.
2. Select the **Configure Included Windows** option and click **New**. Select the new window in the list of windows and enter a descriptive name.
3. Adjust the size (drag the bottom right-hand corner) and the position (click on the text at the top and drag to the desired position) of the window.
4. Adjust the **Object Size**, **History** and **Sensitivity** profile sliders (see *Motion Detection Parameters* for details). Any detected motion within an active window is indicated by red peaks in the **Activity window**.
5. Click **Save**.

To exclude parts of the include window, select the **Configure Excluded Windows** and position the exclude window within the include window.

To delete an include or exclude window, select the window in the list of windows and click **Del**.

Motion Detection Parameters

The parameters controlling motion detection are described in the table below:

Parameter	Object Size	History	Sensitivity
Description	Object size relative to window size.	Object memory length.	Difference in luminance between background and object.
High level (100%)	Only very large objects trigger motion detection.	An object that appears in the window triggers motion detection for a long time before it is considered as non-moving.	Ordinary colored objects on ordinary backgrounds trigger motion detection.
Medium level (50%)			A large difference in luminance is required to trigger motion detection.

AXIS P3301 Fixed Dome Network Camera

Detectors

Low level (0%)	Even very small objects trigger motion detection.	An object that appears in the window triggers motion detection only for a very short time before it is considered as non-moving.	Only very bright objects on a dark background trigger motion detection.
Recommended values	5–15%	60–90%	75–95%
Default values	15%	90%	90%

Note

- To trigger on small objects or movements, use several small motion detection windows rather than one large window and select a low object size.
- To avoid triggering on small objects, select a high object size.
- While monitoring an area where moving objects are not expected, select a high history level. This will cause motion detection to trigger as long as the object is present in the window.
- To only detect flashing light, select a low sensitivity. In other cases high sensitivity is recommended.

Audio Detection

The Axis product can be configured to generate an alarm when audio rises above or falls below the threshold value. The threshold value can be set in the range 0–100 where 0 is the most sensitive and 100 the least sensitive.

1. Go to **Detectors > Audio Detection**.
2. Set the audio alarm level and click **Save**.
3. Go to **Events > Action Rules** and set up an action rule, see *Set Up Action Rules on page 30*.

Detected audio is indicated by colored peaks in the **Activity** indicator. An event is triggered when detected audio rises above or falls below the threshold value, which is represented by the bar.

AXIS P3301 Fixed Dome Network Camera

Applications

Applications

Third party applications can be uploaded to and installed on the Axis product. Applications add functionality to the product, for example video analytics and intelligent video capabilities such as recognition, tracking, detection and counting. For information about available applications, downloads, trials and licenses, go to www.axis.com/applications

Note

- It is recommended to run one application at a time.
- Avoid running applications when the built-in motion detection is active.

AXIS P3301 Fixed Dome Network Camera

Events

Events

The Event pages allow you to configure the Axis product to perform actions when different events occur. For example, the product can start a recording or send an email notification when motion is detected. The set of conditions that defines how and when the action is triggered is called an action rule.

Convert Event Types to Action Rules

If the Axis product is upgraded to firmware version 5.40 or later, it is recommended to convert **Event Types** to **Action Rules**. The legacy user **Event Types** in the camera will continue to work but will not be visible in the user interface of the camera. The **Event Types** need to be converted to **Action** rules to become visible in the user interface.

To convert **Event Types** to **Action Rules** go to **Events > Action Rules** and click **Convert**.

NOTICE

This is not recommended when using a VMS based on the old Event Management System.

Set Up Action Rules

An action rule defines the conditions that must be met for the product to perform an action, for example record video or send an email notification. If multiple conditions are defined, all of them must be met to trigger the action.

For more information about available triggers and actions, see and .

The following example describes how to set up an action rule to record video to a network share if there is movement in the camera's field of view.

Set up motion detection and add a network share:

1. Go to **Detectors > Motion Detection** and configure a motion detection window. See *page 27*
2. Go to **System Options > Storage** and set up the network share. See *page 40*.

Set up the action rule:

1. Go to **Events > Action Rules** and click **Add**.
2. Select **Enable** rule and enter a descriptive name for the rule.
3. Select **Detectors** from the **Trigger** drop-down list.
4. Select **Motion Detection** from the drop-down list. Select the motion detection window to use.
5. Optionally, select a **Schedule** and **Additional conditions**. See below.
6. Under **Actions**, select **Record Video** from the **Type** drop-down list.
7. Select a **Stream profile** and configure the **Duration** settings as described below.
8. Select **Network Share** from the **Storage** drop-down list.

To use more than one trigger for the action rule, select **Additional conditions** and click **Add** to add additional triggers. When using additional conditions, all conditions must be met to trigger the action.

To prevent an action from being triggered repeatedly, a **Wait at least** time can be set. Enter the time in hours, minutes and seconds, during which the trigger should be ignored before the action rule can be activated again.

The recording **Duration** of some actions can be set to include time immediately before and after the event. Select **Pre-trigger time** and/or **Post-trigger time** and enter the number of seconds. When **While the rule is active** is enabled and the action is triggered again during the post-trigger time, the recording time will be extended with another post-trigger time period.

AXIS P3301 Fixed Dome Network Camera

Events

For more information, see the online help  .

Add Recipients

The product can send media files and messages to notify users about events. Before the product can send media files or notification messages, you must define one or more recipients.

To add a recipient:

1. Go to **Events > Recipients** and click **Add**.
2. Enter a descriptive name.
3. Select a recipient **Type**.
4. Enter the information needed for the recipient type.
5. Click **Test** to test the connection to the recipient.
6. Click **OK**.

Create Schedules

Schedules can be used as action rule triggers or as additional conditions, for example to record video if motion is detected outside office hours. Use one of the predefined schedules or create a new schedule as described below.

To create a new schedule:

1. Go to **Events > Schedules** and click **Add**.
2. Enter a descriptive name and the information needed for a daily, weekly, monthly or yearly schedule.
3. Click **OK**.

To use the schedule in an action rule, select the schedule from the **Schedule** drop-down list in the Action Rule Setup page.

Set Up Recurrences

Recurrences are used to trigger action rules repeatedly, for example every 5 minutes or every hour.

To set up a recurrence:

1. Go to **Events > Recurrences** and click **Add**.
2. Enter a descriptive name and recurrence pattern.
3. Click **OK**.

To use the recurrence in an action rule, first select **Time** from the **Trigger** drop-down list in the Action Rule Setup page and then select the recurrence from the second drop-down list.

To modify or remove recurrences, select the recurrence in the **Recurrences List** and click **Modify** or **Remove**.

AXIS P3301 Fixed Dome Network Camera

Recordings

Recordings

The Axis product can be configured to record video continuously or according to an action rule:

- To start a continuous recording, see *page 32*.
- To set up action rules, see *page 30*.
- To access recordings, see *Recording List on page 32*.
- To configure camera controlled storage, see *Storage on page 40*.

Recording List

Recorded videos are listed on the **Recordings > List** page. The list shows each recording's start date and time, duration and the event that triggered the recording.

To play or download a recording, follow these steps:

1. Go to **Recordings > List**.
2. Use the filter to narrow the list of recordings. Enter the desired filter criteria and click **Filter**. Some filters may take a long time to complete.
3. Select the recording.
4. Click **Play** to play the recording, or click **Download** to download the recording.

Multiple recordings can be downloaded at the same time. Select the recordings and click **Download**. The downloaded file is a zip file containing a minimum of three files, of which the Matroska (mkv) files are the actual recordings. The recordings are time-stamped with the date and time they were downloaded (that is, not the date the recordings were made).

Note

To play recordings in Windows Media Player, AXIS Matroska File Splitter must be installed. AXIS Matroska File Splitter can be downloaded from www.axis.com/techsup/software

For detailed recording and video information, select a recording and click **Properties**.

To remove a recording, select the recording and click **Remove**.

Continuous Recording

The Axis product can be configured to continuously save video to a storage device. For information about storage devices, see *Storage on page 40*. To prevent the disk from becoming full, it is recommended to configure the disk to automatically remove old recordings.

If a new stream profile is selected while a recording is ongoing, the recording will be stopped and saved in the recording list and a new recording with the new stream profile will start. All previous continuous recordings will remain in the recording list until they are removed manually or through automatic removal of old recordings.

To start a continuous recording, follow these steps:

1. Go to **Recordings > Continuous**.
2. Select **Enabled**.
3. Select the type of storage device from the **Storage** list.
4. Select a **Stream profile** to use for continuous recordings. To include audio in the recording, use AAC audio encoding and make sure that audio is enabled in the selected stream profile.

AXIS P3301 Fixed Dome Network Camera

Recordings

5. Click **Save** to save and start the recording.

AXIS P3301 Fixed Dome Network Camera

System Options

System Options

Security

Users

User access control is enabled by default and can be configured under **System Options > Security > Users**. An administrator can set up other users by giving them user names and passwords. It is also possible to allow anonymous viewer login, which means that anybody may access the Live View page.

The user list displays authorized users and user groups (access levels):

Viewer – Access to the Live View page

Operator – Access to the Live View page and to all settings except System Options

Administrator – Unrestricted access to all settings; can add, modify and remove other users.

Under **HTTP/RTSP Password Settings**, select the type of password to allow. You may need to allow unencrypted passwords if there are viewing clients that do not support encryption, or if you upgraded the firmware and existing clients support encryption but need to log in again and be configured to use this functionality.

Under **User Settings**, select the **Enable anonymous viewer login** option to allow anonymous users access to the Live View page.

Deselect the **Enable Basic Setup** option to hide the Basic Setup menu. Basic Setup provides quick access to settings that should be made before using the Axis product.

ONVIF

ONVIF (Open Network Video Interface Forum) is a global interface standard that makes it easier for end users, integrators, consultants, and manufacturers to take advantage of the possibilities offered by network video technology. ONVIF enables interoperability between different vendor products, increased flexibility, reduced cost and future-proof systems.

By creating a user you automatically enable ONVIF communication. Use the user name and password with all ONVIF communication with the product. For more information see www.onvif.org

IP Address Filter

IP address filtering is enabled on the **System Options > Security > IP Address Filter** page. Once enabled, the listed IP address are allowed or denied access to the Axis product. Select **Allow** or **Deny** from the list and click **Apply** to enable IP address filtering.

The administrator can add up to 256 IP address entries to the list (a single entry can contain multiple IP addresses).

HTTPS

The Axis product supports encrypted browsing using HTTPS. This is configured on the **System Options > Security > HTTPS** page.

A **self-signed certificate** can be used until a Certificate Authority-issued certificate has been obtained. Click **Create self-signed certificate** to install a self-signed certificate. Although self-signed certificates are free and offer some protection, true security is only implemented after the installation of a signed certificate issued by a Certificate Authority.

To obtain a signed certificate from an issuing Certificate Authority, click **Create Certificate Request**. When the signed certificate is returned, click **Install signed certificate** to import the certificate. The properties of any certificate request currently resident in the product or installed can be viewed by clicking **Properties**.

To enable HTTPS in the Axis product, the **HTTPS Connection Policy** must be set for each user group.

For more information, see the online help .

AXIS P3301 Fixed Dome Network Camera

System Options

IEEE 802.1X

IEEE 802.1X is a standard for port-based Network Admission Control providing secure authentication of wired and wireless network devices. IEEE 802.1X is based on EAP (Extensible Authentication Protocol).

To access a network protected by IEEE 802.1X, devices must authenticate themselves. The authentication is performed by a third-party entity called an authentication server, typically a **RADIUS server**, examples of which are FreeRADIUS and Microsoft Internet Authentication Service.

In Axis' implementation, the network device and the authentication server authenticate themselves with the help of digital certificates using EAP-TLS (Extensible Authentication Protocol - Transport Layer Security). The certificates are provided by an **Certification Authority (CA)**. You need:

- a CA certificate to validate the identity of the authentication server
- a CA-signed client certificate and a private key to authenticate the network device.

To allow the network device to access a network protected by IEEE 802.1X:

1. Obtain a CA certificate, a client certificate and a client private key (contact your network administrator).
2. Go to **Setup > System Options > Security > IEEE 802.1X** and upload the CA certificate, the client certificate and the client private key.
3. Under **Settings**, select the EAPOL version, provide your EAP identity and private key password.
4. Check the box to enable IEEE 802.1X and click **Save**.

Certificates

CA Certificate

The CA certificate is used to validate the identity of the authentication server. Enter the path to the certificate directly, or locate the file using the **Browse** button. Then click **Upload**. To remove a certificate, click **Remove**.

Client certificate Client private key

The client certificate and private key are used to authenticate the network device. They can be uploaded as separate files or in one combined file (e.g. a PFX file or a PEM file). Use the **Client private key** field if uploading one combined file. For each file, enter the path to the file, or locate the file using the **Browse** button. Then click **Upload**. To remove a file, click **Remove**.

Settings

EAPOL version

Select the EAPOL version (1 or 2) as used in your network switch.

EAP identity

Enter the user identity (maximum 16 characters) associated with your certificate.

Private key password

Enter the password (maximum 16 characters) for the private key.

Enable IEEE 802.1X

Check the box to enable the IEEE 802.1X protocol.

Audio Support

Select **Enable audio support** to allow clients to retrieve audio streams from the Axis product. For information on how to configure audio settings, see *Audio Settings on page 20*.

Note

Deselecting this option will disable audio globally in the Axis product, for configured events and profiles with audio as well.

Date & Time

The Axis product's date and time settings are configured under **System Options > Date & Time**.

Current Server Time displays the current date and time (24h clock). The time can be displayed in 12h clock in the text overlay (see below).

AXIS P3301 Fixed Dome Network Camera

System Options

To change the date and time settings, select the preferred **Time mode** under **New Server Time**:

- **Synchronize with computer time** – Sets date and time according to the computer's clock. With this option, date and time are set once and will not be updated automatically.
- **Synchronize with NTP Server** – Obtains date and time from an NTP server. With this option, date and time settings are updated continuously. For information on NTP settings, see *NTP Configuration on page 37*.
If using a host name for the NTP server, a DNS server must be configured. See *DNS Configuration on page 37*.
- **Set manually** – Allows you to manually set date and time.

If using an NTP server, select your **Time zone** from the drop-down list. If required, check **Automatically adjust for daylight saving time changes**.

The **Date & Time Format Used in Images** is the date and time format displayed as a text overlay in the video stream. Use the predefined formats or see *File Naming & Date/Time Formats* in the online help  for information on how to create custom date and time formats. To include date and time in the overlay text, go to **Video & Audio** and select **Include date** and **Include time**.

Network

Basic TCP/IP Settings

The Axis product supports IP version 4 and IP version 6. Both versions can be enabled simultaneously, and at least one version must always be enabled.

IPv4 Address Configuration

By default, the Axis product is set to use IPv4 (IP version 4) and to obtain the IP address automatically via DHCP. The IPv4 settings are configured under **System Options > Network > TCP/IP > Basic**.

DHCP (Dynamic Host Configuration Protocol) allows network administrators to centrally manage and automate the assignment of IP addresses. DHCP should only be enabled if using dynamic IP address notification, or if the DHCP can update a DNS server. It is then possible to access the Axis product by name (host name).

If DHCP is enabled and the product cannot be accessed, run **AXIS IP Utility** to search the network for connected Axis products, or reset the product to the factory default settings (see *page 43*) and then perform the installation again.

To use a static IP address, check **Use the following IP address** and specify the IP address, subnet mask and default router.

IPv6 Address Configuration

If IPv6 (IP version 6) is enabled, the Axis product will receive an IP address according to the configuration in the network router.

To enable IPv6, go to **System Options > Network > TCP/IP > Basic**. Other settings for IPv6 should be configured in the network router.

ARP/Ping

The product's IP address can be assigned using ARP and Ping. For instructions, see .

The ARP/Ping service is enabled by default but is automatically disabled two minutes after the product is started, or as soon as an IP address is assigned. To re-assign IP address using ARP/Ping, the product must be restarted to enable ARP/Ping for an additional two minutes.

To disable the service, go to **System Options > Network > TCP/IP > Basic** and clear the option **Enable ARP/Ping setting of IP address**.

Pinging the product is still possible when the service is disabled.

AXIS P3301 Fixed Dome Network Camera

System Options

AXIS Video Hosting System (AVHS)

AVHS used in conjunction with an AVHS service, provides easy and secure Internet access to live and recorded video accessible from any location. For more information and help to find a local AVHS Service Provider go to www.axis.com/hosting

The AVHS settings are configured under **System Options > Network > TCP/IP > Basic**. The possibility to connect to an AVHS service is enabled by default. To disable, clear the **Enable AVHS** box.

One-click enabled – Press and hold the product's control button (see *Hardware Overview on page 5*) for about 3 seconds to connect to an AVHS service over the Internet. Once registered, **Always** will be enabled and the Axis product stays connected to the AVHS service. If the product is not registered within 24 hours from when the button is pressed, the product will disconnect from the AVHS service.

Always – The Axis product will constantly attempt to connect to the AVHS service over the Internet. Once registered the product will stay connected to the service. This option can be used when the product is already installed and it is not convenient to use the one-click installation.

AXIS Internet Dynamic DNS Service

AXIS Internet Dynamic DNS Service assigns a host name for easy access to the product. For more information, see www.axiscam.net

To register the Axis product with AXIS Internet Dynamic DNS Service, go to **System Options > Network > TCP/IP > Basic**. Under **Services**, click the **AXIS Internet Dynamic DNS Service Settings** button (requires access to the Internet). The domain name currently registered at AXIS Internet Dynamic DNS service for the product can at any time be removed.

Note

AXIS Internet Dynamic DNS Service requires IPv4.

Advanced TCP/IP Settings

DNS Configuration

DNS (Domain Name Service) provides the translation of host names to IP addresses. The DNS settings are configured under **System Options > Network > TCP/IP > Advanced**.

Select **Obtain DNS server address via DHCP** to use the DNS settings provided by the DHCP server.

To make manual settings, select **Use the following DNS server address** and specify the following:

Domain name – Enter the domain(s) to search for the host name used by the Axis product. Multiple domains can be separated by semicolons. The host name is always the first part of a fully qualified domain name, for example, `myserver` is the host name in the fully qualified domain name `myserver.mycompany.com` where `mycompany.com` is the domain name.

Primary/Secondary DNS server – Enter the IP addresses of the primary and secondary DNS servers. The secondary DNS server is optional and will be used if the primary is unavailable.

NTP Configuration

NTP (Network Time Protocol) is used to synchronize the clock times of devices in a network. The NTP settings are configured under **System Options > Network > TCP/IP > Advanced**.

Select **Obtain NTP server address via DHCP** to use the NTP settings provided by the DHCP server.

To make manual settings, select **Use the following NTP server address** and enter the host name or IP address of the NTP server.

Host Name Configuration

The Axis product can be accessed using a host name instead of an IP address. The host name is usually the same as the assigned DNS name. The host name is configured under **System Options > Network > TCP/IP > Advanced**.

Select **Obtain host name via IPv4 DHCP** to use host name provided by the DHCP server running on IPv4.

AXIS P3301 Fixed Dome Network Camera

System Options

Select **Use the host name** to set the host name manually.

Select **Enable dynamic DNS updates** to dynamically update local DNS servers whenever the Axis product's IP address changes.

For more information, see the online help .

Link-Local IPv4 Address

Link-Local Address is enabled by default and assigns the Axis product an additional IP address which can be used to access the product from other hosts on the same segment on the local network. The product can have a Link-Local IP and a static or DHCP-supplied IP address at the same time.

This function can be disabled under **System Options > Network > TCP/IP > Advanced**.

HTTP

The HTTP port used by the Axis product can be changed under **System Options > Network > TCP/IP > Advanced**. In addition to the default setting, which is 80, any port in the range 1024–65535 can be used.

HTTPS

The HTTPS port used by the Axis product can be changed under **System Options > Network > TCP/IP > Advanced**. In addition to the default setting, which is 443, any port in the range 1024–65535 can be used.

To enable HTTPS, go to **System Options > Security > HTTPS**. For more information, see *HTTPS on page 34*

NAT traversal (port mapping) for IPv4

A network router allows devices on a private network (LAN) to share a single connection to the Internet. This is done by forwarding network traffic from the private network to the "outside", that is, the Internet. Security on the private network (LAN) is increased since most routers are pre-configured to stop attempts to access the private network (LAN) from the public network (Internet).

Use **NAT traversal** when the Axis product is located on an intranet (LAN) and you wish to make it available from the other (WAN) side of a NAT router. With NAT traversal properly configured, all HTTP traffic to an external HTTP port in the NAT router is forwarded to the product.

NAT traversal is configured under **System Options > Network > TCP/IP > Advanced**.

Note

- For NAT traversal to work, this must be supported by the router. The router must also support UPnP™.
- The router has many different names: "NAT router", "Network router", "Internet Gateway", "Broadband router", "Broadband sharing device" or "Home firewall" but the essential purpose of the device is the same.

Enable/Disable – When enabled, the Axis product attempts to configure port mapping in a NAT router on your network, using UPnP™. Note that UPnP™ must be enabled in the product (see **System Options > Network > UPnP**).

Use manually selected NAT router – Select this option to manually select a NAT router and enter the IP address for the router in the field. If no router is specified, the product automatically searches for NAT routers on your network. If more than one router is found, the default router is selected.

Alternative HTTP port – Select this option to manually define an external HTTP port. Enter the port number in the field. If no port is entered here, a port number is automatically selected when NAT traversal is enabled.

Note

- An alternative HTTP port can be used or be active even if NAT traversal is disabled. This is useful if your NAT router does not support UPnP and you need to manually configure port forwarding in the NAT router.
- If you attempt to manually enter a port that is already in use, another available port is automatically selected.
- When the port is selected automatically it is displayed in this field. To change this, enter a new port number and click **Save**.

AXIS P3301 Fixed Dome Network Camera

System Options

FTP

The FTP server running in the Axis product enables upload of new firmware, user applications, etc. The FTP server can be disabled under **System Options > Network > TCP/IP > Advanced**.

Note

This FTP server has nothing to do with the product's ability to transfer images via FTP to other locations and servers.

RTSP

The RTSP server running in the Axis product allows a connecting client to start an H.264 stream. The RTSP port number can be changed under **System Options > Network > TCP/IP > Advanced**. The default port is 554.

Note

H.264 video streams will not be available if the RTSP server is disabled.

SOCKS

SOCKS is a networking proxy protocol. The Axis product can be configured to use a SOCKS server to reach networks on the other side of a firewall or proxy server. This functionality is useful if the Axis product is located on a local network behind a firewall, and notifications, uploads, alarms, etc need to be sent to a destination outside the local network (for example the Internet).

SOCKS is configured under **System Options > Network > SOCKS**. For more information, see the online help .

QoS (Quality of Service)

QoS (Quality of Service) guarantees a certain level of a specified resource to selected traffic on a network. A QoS-aware network prioritizes network traffic and provides a greater network reliability by controlling the amount of bandwidth an application may use.

The QoS settings are configured under **System Options > Network > QoS**. Using DSCP (Differentiated Services Codepoint) values, the Axis product can mark different types of traffic.

Note

Live audio DSCP will be equal to live video DSCP if H.264 over RTSP is used.

SMTP (email)

To send email messages from the Axis product via SMTP (Simple Mail Transfer Protocol), an SMTP mail server must be set up. This is done under **System Options > Network > SMTP (email)**.

Enter the host names or IP addresses and port numbers for the primary and secondary mail servers in the fields provided. A **From email address** is also required. If the mail server requires authentication, check **Use authentication to log in to this server** and enter the necessary information.

SNMP

The Simple Network Management Protocol (SNMP) allows remote management of network devices. An SNMP community is the group of devices and management station running SNMP. Community names are used to identify groups.

To enable and configure SNMP in the Axis product, go to the **System Options > Network > SNMP** page.

Depending on the level of security required, select the version on SNMP to use.

Traps are used by the Axis product to send messages to a management system on important events and status changes. Check **Enable traps** and enter the IP address where the trap message should be sent and the **Trap community** that should receive the message.

Note

If HTTPS is enabled, SNMP v1 and SNMP v2c should be disabled.

AXIS P3301 Fixed Dome Network Camera

System Options

Traps for SNMP v1/v2 are used by the Axis product to send messages to a management system on important events and status changes. Check **Enable traps** and enter the IP address where the trap message should be sent and the **Trap community** that should receive the message.

The following traps are available:

- Cold start
- Warm start
- Link up
- Authentication failed

SNMP v3 provides encryption and secure passwords. To use traps with SNMP v3, an SNMP v3 management application is required.

To use SNMP v3, HTTPS must be enabled, see *HTTPS on page 34*. To enable SNMP v3, check the box and provide the initial user password.

Note

The initial password can only be set once. If the password is lost, the Axis product must be reset to factory default, see *Reset to Factory Default Settings on page 43*.

UPnP™

The Axis product includes support for UPnP™. UPnP™ is enabled by default and the product is automatically detected by operating systems and clients that support this protocol.

UPnP™ can be disabled under **System Options > Network > UPnP™**.

RTP/H.264

The RTP port range and multicast settings are configured under **System Options > Network > RTP**.

The RTP port range defines the range of ports from which the video/audio ports are automatically selected. For multicast streams, only certain IP addresses and port numbers should be used.

Select **Always Multicast Video** and/or **Always Multicast Audio** to start multicast streaming without opening an RTSP session.

Bonjour

The Axis product includes support for Bonjour. Bonjour is enabled by default and the product is automatically detected by operating systems and clients that support this protocol.

Bonjour can be disabled under **System Options > Network > Bonjour**.

Storage

Network Share

Network share allows you to add network storage such as a NAS (network-attached storage). The NAS shall be dedicated for recordings and data from the Axis products connected to the network. For information about reference NAS devices, go to www.axis.com/products/cam_companion_software/supported.htm

Note

For NAS recommendations see www.axis.com

To add a network share:

1. Go to **System Options > Storage**.

AXIS P3301 Fixed Dome Network Camera

System Options

2. Click **Network Share**.
3. Enter the IP address, DNS or Bonjour name to the host server in the **Host** field.
4. Enter the name of the share in the **Share** field. Sub folders cannot be used.
5. If required, select **The share requires login** and enter the user name and password.
6. Click **Connect**.

To clear all recordings and data from the Axis product's folder on the designated share, click **Clear** under **Storage Tools**.

To avoid filling the share, it is recommended to remove recordings continuously. Under **Recording Settings**, select **Remove recordings older than** and select the number of days or weeks.

To stop writing to the share and protect recordings from being removed, select **Lock** under **Recording Settings**.

Ports & Devices

I/O Ports

The Axis product provides one input port and one output port for connection of external devices. For information about how to connect external devices, see .

The I/O ports are configured under **System Options > Ports & Devices > I/O Ports**. The ports can be given descriptive names and their **Normal states** can be configured as **Open circuit** or **Grounded circuit**.

Port Status

The list on the **System Options > Ports & Devices > Port Status** page shows the status of the product's input and output ports.

Maintenance

The Axis product provides several maintenance functions. These are available under **System Options > Maintenance**.

Click **Restart** to perform a correct restart if the Axis product is not behaving as expected. This will not affect any of the current settings.

Note

A restart clears all entries in the Server Report.

Click **Restore** to reset most settings to the factory default values. The following settings are not affected:

- the boot protocol (DHCP or static)
- the static IP address
- the default router
- the subnet mask
- the system time
- the IEEE 802.1X settings
- the focus position
- uploaded applications are kept but must be restarted

Click **Default** to reset all settings, including the IP address, to the factory default values. This button should be used with caution. The Axis product can also be reset to factory default using the control button, see *Reset to Factory Default Settings on page 43*.

AXIS P3301 Fixed Dome Network Camera

System Options

To identify the product or test the Status LED, click **Flash LED** under **Identify** and specify the duration in seconds, minutes or hours. This can be useful for identifying the product among other products installed in the same location.

For information about firmware upgrade, see *Upgrade the Firmware on page 44*.

Support

Support Overview

The **System Options > Support > Support Overview** page provides information on troubleshooting and contact information, should you require technical assistance.

See also *Troubleshooting on page 44*.

System Overview

To get an overview of the Axis product's status and settings, go to **System Options > Support > System Overview**. Information that can be found here includes firmware version, IP address, network and security settings, event settings, image settings and recent log items. Many of the captions are links to the proper Setup page.

Logs & Reports

The **System Options > Support > Logs & Reports** page generates logs and reports useful for system analysis and troubleshooting. If contacting Axis Support, please provide a valid Server Report with your query.

System Log – Provides information about system events.

Access Log – Lists all failed attempts to access the product. The Access Log can also be configured to list all connections to the product (see below).

Server Report – Provides information about the product status in a pop-up window. The Access Log is automatically included in the Server Report.

You can view or download the server report. Downloading the server report creates a .zip file that contains a complete server report text file in UTF-8 format. Select the **Include snapshot with default image settings** option to include a snapshot of the product's Live View. The server report .zip file should always be included when contacting support.

Parameter List – Shows the product's parameters and their current settings. This may prove useful when troubleshooting or when contacting Axis Support.

Connection List – Lists all clients that are currently accessing media streams.

Crash Report – Generates an archive with debugging information. The report takes several minutes to generate.

The log levels for the System Log and the Access Log are set under **System Options > Support > Logs & Reports > Configuration**. The Access Log can be configured to list all connections to the product (select Critical, Warnings & Info).

Advanced

Scripting

Scripting allows experienced users to customize and use their own scripts.

NOTICE

Improper use may cause unexpected behavior and loss of contact with the Axis product.

Axis strongly recommends that you do not use this function unless you understand the consequences. Axis Support does not provide assistance for problems with customized scripts.

AXIS P3301 Fixed Dome Network Camera

System Options

To open the Script Editor, go to **System Options > Advanced > Scripting**. If a script causes problems, reset the product to its factory default settings, see *page 43*.

For more information, see www.axis.com/developer

File Upload

Files, for example web pages and images, can be uploaded to the Axis product and used as custom settings. To upload a file, go to **System Options > Advanced > File Upload**.

Uploaded files are accessed through `http://<ip address>/local/<user>/<file name>` where `<user>` is the selected user group (viewer, operator or administrator) for the uploaded file.

Plain Config

Plain Config is for advanced users with experience of Axis product configuration. Most parameters can be set and modified from this page.

To open Plain Config, go to **System Options > Advanced > Plain Config**. Axis Support does not provide assistance.

Reset to Factory Default Settings

Important

Reset to factory default should be used with caution. A reset to factory default will reset all settings, including the IP address, to the factory default values.

Note

The installation and management software tools are available on the CD supplied with the product and from the support pages on www.axis.com/techsup

To reset the product to the factory default settings:

1. Disconnect power from the product.
2. Press and hold the control button and reconnect power. See *Hardware Overview on page 5*.
3. Keep the control button pressed for about 15–30 seconds until the status LED indicator flashes amber.
4. Release the control button. The process is complete when the status LED indicator turns green. The product has been reset to the factory default settings. If no DHCP server is available on the network, the default IP address is 192.168.0.90
5. Using the installation and management software tools, assign an IP address, set the password, and access the video stream.

It is also possible to reset parameters to factory default via the web interface. Go to **Setup > System Options > Maintenance**.

AXIS P3301 Fixed Dome Network Camera

Troubleshooting

Troubleshooting

Check the Firmware

Firmware is software that determines the functionality of network devices. One of your first actions when troubleshooting a problem should be to check the current firmware version. The latest version may contain a correction that fixes your particular problem. The current firmware version in the Axis product is displayed in the page **Setup > Basic Setup** and in **Setup > About**.

Upgrade the Firmware

Important

- Your dealer reserves the right to charge for any repair attributable to faulty upgrade by the user.
- Preconfigured and customized settings are saved when the firmware is upgraded (providing the features are available in the new firmware) although this is not guaranteed by Axis Communications AB.

Note

- After the upgrade process has completed, the product will restart automatically. If restarting the product manually after the upgrade, always wait 10 minutes even if you suspect the upgrade has failed.
- When you upgrade the Axis product with the latest firmware from Axis website, the product receives the latest functionality available. Always read the upgrade instructions and release notes available with each new release before upgrading the firmware.

To upgrade the product's firmware:

1. Save the firmware file to your computer. The latest version of the firmware is available free of charge from Axis website at www.axis.com/techsup
2. Go to **Setup > System Options > Maintenance** in the product's web pages.
3. Under **Upgrade Server**, click **Browse** and locate the file on your computer. Click **Upgrade**.
4. Wait approximately 10 minutes while the product is being upgraded and restarted. Then access the product.

AXIS Camera Management can be used for multiple upgrades. See www.axis.com for more information.

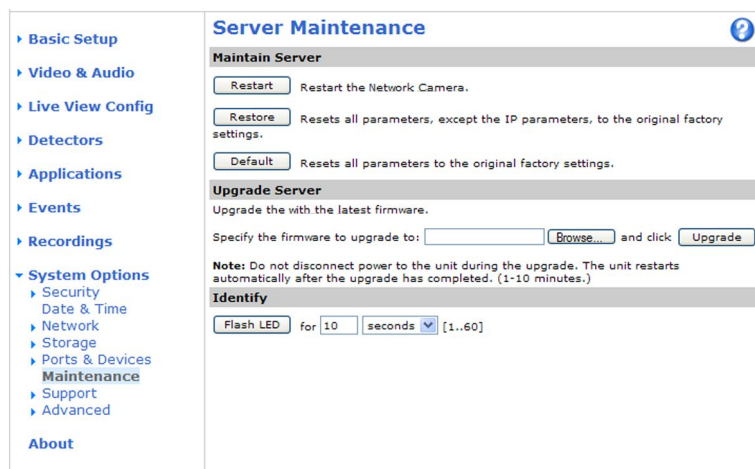

AXIS P3301 Fixed Dome Network Camera

Troubleshooting

Emergency Recovery Procedure

If power or network connection is lost during the upgrade, the process fails and the product becomes unresponsive. Flashing red Status indicator indicates a failed upgrade. To recover the product, follow the steps below. The serial number is found on the product's label.

1. In **UNIX/Linux**, type the following from the command line:

```
arp -s <IP address> <serial number> temp  
ping -l 408 <IP address>
```

In **Windows**, type the following from a command/DOS prompt (this may require that you run the command prompt as an administrator):

```
arp -s <IP address> <serial number>  
ping -l 408 -t <IP address>
```

2. If the product does not reply in 30 seconds, restart it and wait for a reply. Press CTRL+C to stop Ping.
3. Open a browser and type in the product's IP address. In the page that opens, use the **Browse** button to select the upgrade file to use. Then click **Load** to restart the upgrade process.
4. After the upgrade is complete (1–10 minutes), the product automatically restarts and shows a steady green on the Status indicator.
5. Reinstall the product, referring to the Installation Guide.

If the emergency recovery procedure does not get the product up and running again, contact Axis support at www.axis.com/techsup/

Symptoms, Possible Causes and Remedial Actions

Problems setting the IP address

When using ARP/Ping	Try the installation again. The IP address must be set within two minutes after power has been applied to the product. Ensure the Ping length is set to 408. For instructions, see .
The product is located on a different subnet	If the IP address intended for the product and the IP address of the computer used to access the product are located on different subnets, you will not be able to set the IP address. Contact your network administrator to obtain an IP address.
The IP address is being used by another device	Disconnect the Axis product from the network. Run the Ping command (in a Command/DOS window, type <code>ping</code> and the IP address of the product): <ul style="list-style-type: none">• If you receive: <code>Reply from <IP address>: bytes=32; time=10...</code> this means that the IP address may already be in use by another device on the network. Obtain a new IP address from the network administrator and reinstall the product.• If you receive: <code>Request timed out</code>, this means that the IP address is available for use with the Axis product. Check all cabling and reinstall the product.
Possible IP address conflict with another device on the same subnet.	The static IP address in the Axis product is used before the DHCP server sets a dynamic address. This means that if the same default static IP address is also used by another device, there may be problems accessing the product.

The product cannot be accessed from a browser

Cannot log in	When HTTPS is enabled, ensure that the correct protocol (HTTP or HTTPS) is used when attempting to log in. You may need to manually type <code>http</code> or <code>https</code> in the browser's address field. If the password for the user <code>root</code> is lost, the product must be reset to the factory default settings. See <i>Reset to Factory Default Settings on page 43</i> .
---------------	--

AXIS P3301 Fixed Dome Network Camera

Troubleshooting

The IP address has been changed by DHCP	IP addresses obtained from a DHCP server are dynamic and may change. If the IP address has been changed, use AXIS IP Utility or AXIS Camera Management to locate the product on the network. Identify the product using its model or serial number, or by the DNS name (if the name has been configured). If required, a static IP address can be assigned manually. For instructions, see the Installation and Management Software CD or the document <i>Assign an IP Address and Access the Video Stream</i> on Axis Support web at www.axis.com/techsup .
Certificate error when using IEEE 802.1X	For authentication to work properly, the date and time settings in the Axis product should be synchronized with an NTP server. See <i>Date & Time</i> on page 35.

The product is accessible locally but not externally

Router configuration	To configure your router to allow incoming data traffic to the Axis product, enable the NAT-traversal feature which will attempt to automatically configure the router to allow access to the Axis product, see <i>NAT traversal (port mapping) for IPv4</i> on page 38. The router must support UPnP™.
Firewall protection	Check the Internet firewall with your network administrator.
Default routers required	Check if you need to configure the router settings from System Options > Network > TCP/IP > Basic .

Problems with streaming H.264

Problems with AXIS Media Control (<i>Internet Explorer only</i>)	To enable the updating of video images in Internet Explorer, set the browser to allow ActiveX controls. Also, make sure that AXIS Media Control is installed on your computer.
No H.264 displayed in the client	Check that the relevant H.264 connection methods and correct interface are enabled in the AMC Control Panel (streaming tab). See <i>AXIS Media Control (AMC)</i> on page 12. In the AMC Control Panel, select the H.264 tab and click Set to default H.264 decoder . Check that RTSP is enabled under System Options > Network > TCP/IP > Advanced .
Multicast H.264 only accessible by local clients	Check if your router supports multicasting, or if the router settings between the client and the product need to be configured. The TTL (Time To Live) value may need to be increased.
No multicast H.264 displayed in the client	Check with your network administrator that the multicast addresses used by the Axis product are valid for your network. Check with your network administrator to see if there is a firewall preventing viewing.
Installation of additional ActiveX component restricted or prohibited	Configure the Axis product to use a Java applet for updating video images in your browser. Go to Setup > Live View Config and select Java applet under Default viewer .
Poor rendering of H.264 images	Ensure that your graphics card is using the latest driver. The latest drivers can usually be downloaded from the manufacturer's website.
Color saturation is different in H.264 and Motion JPEG	Modify the settings for your graphics adapter. Refer to the adapter's documentation for more information.

AXIS P3301 Fixed Dome Network Camera

Troubleshooting

Lower frame rate than expected

See *Performance Considerations* on page 50.

Reduce the number of applications running on the client computer.

Limit the number of simultaneous viewers.

Check with the network administrator that there is enough bandwidth available.

Check in the AMC Control Panel (H.264 tag) that video processing is NOT set to **Decode only key frames**.

Lower the image resolution.

Status and Network indicator LEDs are flashing red rapidly

Hardware failure

Contact your Axis reseller.

Video and image problems, general

Image unsatisfactory

Check the video stream and camera settings under **Setup > Video & Audio > Video Stream and Setup > Video & Audio > Camera Settings**.

Motion Detection triggers unexpectedly

Changes in luminance

Motion detection is based on changes in luminance in the image. This means that if there are sudden changes in the lighting, motion detection may trigger mistakenly. Lower the sensitivity setting to avoid problems with luminance.

No audio

Incorrect setup

Check the sound card in the computer. Ensure that mute is not selected and that the volume settings are correct.

Check that **Enable audio support** is selected under **Setup > System Options > Security > Audio Support**.

Check that the correct **Audio Input** source is selected under **Setup > Video & Audio > Audio Settings**.

Poor audio quality

Stuttering

Reduce the number of listeners and viewers. Decrease image resolution and compression.

Unsynchronized audio and video using H.264

Synchronize the product's date and time settings with an NTP server. Go to **Setup > System Options > Date & Time**.

Distorted audio

Check that the correct **Audio Input** source is selected under **Setup > Video & Audio > Audio Settings**.

Feedback loops

Feedback loops might appear in full-duplex mode. Try moving the microphone or the speaker, or use half-duplex mode instead.

AXIS P3301 Fixed Dome Network Camera

Technical Specifications

Technical Specifications

Function/group	Item	Specifications
Camera	Models	AXIS P3301
	Image sensor	Progressive scan RGB CMOS 1/4"
	Lens	Varifocal 2.8 – 10 mm, F1.3, DC-iris Horizontal angle of view: 72° – 23° Vertical angle of view: 41° – 14°
	Minimum illumination	1 lux, F1.3
	Shutter time	1/20000 s to 1/4 s
	Camera angle adjustment	Pan 360°, tilt 170°, rotation 340°
Video	Video compression	H.264 Baseline Profile (MPEG-4 Part 10/AVC) Motion JPEG
	Resolutions	640x480 to 160x120
	Frame rate H.264	30 fps in all resolutions
	Frame rate Motion JPEG	30 fps in all resolutions
	Video streaming	Multi-stream H.264 and Motion JPEG: 3 simultaneous, individually configured streams in max. resolution at 30 fps; more streams in either compression if identical or limited in frame rate/resolution
	Image settings	Compression, color, brightness, sharpness, contrast, white balance, exposure control, exposure zones, backlight compensation, fine tuning of behavior at low light, wide dynamic range – dynamic contrast Rotation: 0°, 90°, 180°, 270°, including Corridor Format™ Mirroring of images, text and image overlay, privacy mask
Audio	Audio streaming	Two-way
	Audio compression	AAC LC 8 kHz 32 kbit/s, 16 kHz 64 kbit/s G.711 PCM 8 kHz 64 kbit/s G.726 ADPCM 8 kHz 32 kbit/s or 24 kbit/s Configurable bit rate
	Audio input/output	Built-in microphone, external microphone input or line input, line level output
Network	Security	Password protection, IP address filtering, HTTPS encryption*, IEEE 802.1X network access control*, digest authentication, user access log *This product includes software developed by the Open SSL Project for use in the Open SSL Toolkit (www.openssl.org)
	Supported protocols	IPv4/v6, HTTP, HTTPS*, SSL/TLS*, QoS Layer 3 DiffServ, FTP, SMTP, Bonjour, UPnP, SNMPv1/v2c/v3(MIB-II), DNS, DynDNS, NTP, RTSP, RTP, TCP, UDP, IGMP, RTCP, ICMP, DHCP, ARP, SOCKS *This product includes software developed by the Open SSL Project for use in the Open SSL Toolkit (www.openssl.org)

AXIS P3301 Fixed Dome Network Camera

Technical Specifications

Function/group	Item	Specifications
System Integration	Application Programming Interface	Open API for software integration, including ONVIF, specification available at www.onvif.org , as well as VAPIX® and AXIS Camera Application Platform from Axis Communications, specifications available at www.axis.com Support for AXIS Video Hosting System (AVHS) with One-Click Camera Connection Event trigger data in video stream Embedded Linux operating system
	Intelligent video	Video motion detection, active tampering alarm, audio detection Support for AXIS Camera Application Platform enabling installation of additional applications
	Triggers	Intelligent video, external input, on boot
	Actions	File upload via FTP, HTTP and email Notification via email, HTTP and TCP Video and audio recording to edge storage External output activation Play audio clip Pre- and post alarm video buffering
	Video access from web browser	Camera live view Video recording to file (ASF) Customizable HTML pages Windows 7, Windows Vista, Windows XP, Windows Server 2008, Windows Server 2003 DirectX 9c or higher For other operating systems and browsers, see www.axis.com/techsup
	Installation aids	Pixel counter
	Management and maintenance	AXIS Camera Management tool on CD and web-based configuration Configuration of backup and restore Firmware upgrades over HTTP or FTP, firmware available on www.axis.com
General	Casing	Polycarbonate transparent cover Metal inner camera module with encapsulated electronics Tamper-resistant plastic casing
	Processor, memory	ARTPEC-3, 128 MB RAM, 128 MB Flash
	Power	4.9 – 5.1 v DC max. 4.7 W Power over Ethernet IEEE 802.3.af Class 2 (max. 4.7 W)
	Connectors	RJ-45 10BASE-T/100BASE-TX PoE, DC jack 3.5 mm jack for mic in (max 80 mVpp) or line mono input (max 6.4 Vpp) 3.5 mm jack for line mono output (max 2.0 Vpp) to active speaker Terminal block for 1 alarm input and 1 output
	Edge storage	Support for recording to network share (Network Attached Storage or file server)
	Operating conditions	Temperature: 0 °C to 50 °C (32 °F to 122 °F) Humidity 20–80% RH (non-condensing)
	Approvals	EN 55022 Class B, EN 61000-3-2, EN 61000-3-3, EN 55024 FCC Part 15 Subpart B Class B ICES-003 Class B VCCI Class B C-tick AS/NZS CISPR 22 EN 60950-1 (IEC 60950-1) Power supply: EN 60950-1, UL, CSA

AXIS P3301 Fixed Dome Network Camera

Technical Specifications

Function/group	Item	Specifications
	Dimensions (HxWxD)	94 mm x 144 mm x 132 mm (3.7" x 5.7" x 5.2")
	Weight	0.4 kg (0.9 lb.)
	Included accessories	Mounting and connector kits, clear and smoked dome cover, Installation Guide, CD with User Manual, recording software, installation and management tools, Windows decoder 1-user license, smoked transparent cover
	Video management software (not included)	AXIS Camera Station – Video management software for viewing and recording up to 50 cameras See www.axis.com/products/video/software/ for more software applications via partners
	Optional accessories	AXIS T8412 Installation Display AXIS PoE Midspans AXIS P8221 Network I/O Audio Module AXIS Camera Management AXIS Pendant kit, mounting bracket

Performance Considerations

When setting up your system, it is important to consider how various settings and situations will affect performance. Some factors affect the amount of bandwidth (the bit rate) required, others can affect the frame rate, and some affect both. If the load on the CPU reaches its maximum, this will also affect the frame rate.

The following factors are among the most important to consider:

- High image resolution and/or lower compression levels result in images containing more data. Bandwidth affected.
- Access by large numbers of Motion JPEG and/or unicast H.264 clients. Bandwidth affected.
- Simultaneous viewing of different streams (resolution, compression) by different clients. Effect on frame rate and bandwidth.
- Accessing Motion JPEG and H.264 video streams simultaneously. Frame rate and bandwidth affected.
- Heavy usage of event settings affect the product's CPU load. Frame rate affected.
- Heavy network utilization due to poor infrastructure. Bandwidth affected.
- Viewing on poorly performing client computers lowers perceived performance. Frame rate affected.

